

GHKU TOTAL LOCK SERIES KINGPINLESS CASTERS

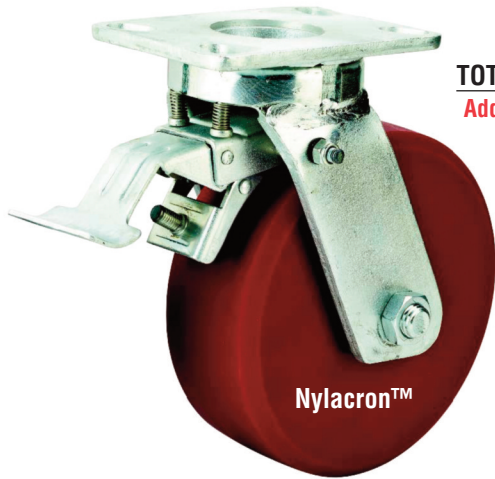

**LEADING SIDE
TOTAL LOCK SWIVEL CASTER**
Add TL to swivel caster number

Available Toe Guard TO

Nylacron™

**NEW TRAILING SIDE
TOTAL LOCK SWIVEL CASTER**
No need to move cots back and forth
for finding the brake pedal.
Add TLT to swivel caster number
Available in 6" & 8"

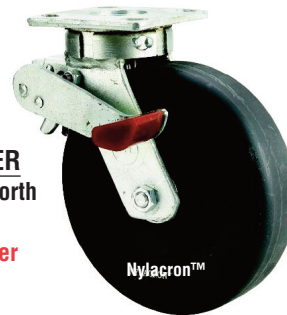

Nylacron™

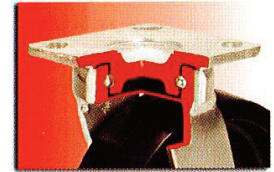

Swivel Head Section

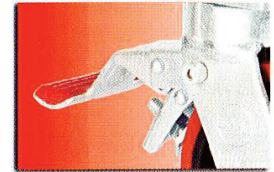

Total Lock System



Wheel Face Brake

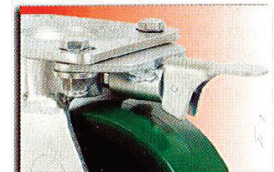

Directional Lock

2,000 LBS. LOAD CAPACITY FORGED KINGPINLESS TYPE CASTERS

- Single piece Drop Forged AISI 1045 Steel Top Plate and Fork Base
- Precision CNC Machined Raceways with Kingpinless construction
- Induction Hardening of Raceways ensures uniform depth of hardness
- Totally Sealed Swivel Head with Grease Nipple
- 1/4" Thick Fork Legs robotically welded inside & outside to 2 1/2" fork spacing
- 1/2" Wheel axle
- 4 Position Foot Operated Directional Lock Slots
- Finish: Bright Zinc Plated

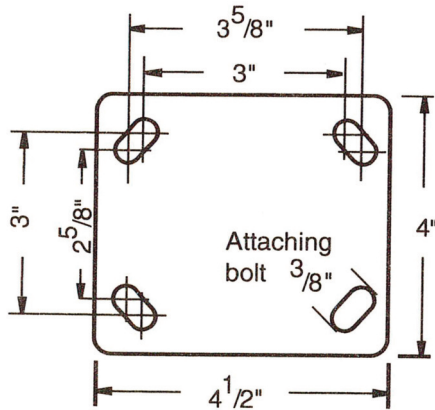

TOP PLATE
4 X 4-1/2

BOLT HOLE CENTER
2-5/8 X 3-5/8
SLOTTED TO
3 X 3

ATTACHING BOLT SIZE
3/8

RIG OPTIONS
DL: FOOT OPERATED
4-WAY DIRECTIONAL LOCK
WFB: WHEEL FACE BRAKE
ADD TO SUFFIX
TO THE CASTER PART NUMBER

LTP TOP PLATE SIZE AVAILABLE 4-1/2 X 6-1/4
ADD LTP TO PART NUMBERS

4

GHKU TOTAL LOCK SERIES KINGPINLESS CASTERS

SAS WHEELS

HIGH CAPACITY POLYURETHANE TREAD WHEELS CAST IRON CORE

- Polyurethane firmly bonded to Precision Machined Cast Iron Core
- 93+ 3 Shore A
- Low rolling resistance, smooth and noiseless running

- Non-marking and floor protective
- High abrasion, cut and tear resistant
- Precision Ball Bearings
- Temperature Range: -40°F to +180°F
- **Available in Anti-Static add "AS" after wheel**



Part Number Swivel Caster	Part Number Swivel with Total Lock	Part Number Rigid Caster	Wheel Diameter (inch)	Tread Width (inch)	Load Capacity (lbs)	Overall Height (inch)	Swivel Radius (inch)	Swivel Radius w/Total Lock (inch)	Swivel Radius w/Wheel Brake (inch)
GHKU42SSAS	GHKU42SSASTL	GHKU42RSAS	4	2	900	5-5/8	3-3/16	4	8-1/2
GHKU52SSAS	GHKU52SSASTL	GHKU52RSAS	5	2	1200	6-1/2	3-7/8	4	9-1/2
GHKU62SSAS	GHKU62SSASTL	GHKU62RSAS	6	2	1650	7-1/2	4-9/16	6	10
GHKU82SSAS	GHKU82SSASTL	GHKU82RSAS	8	2	2000	9-1/2	6	6	11-1/2

ME WHEELS

ERGONOMIC POLYURETHANE DONUT TREAD WHEELS ALUMINUM CORE

- For Low Push-Pull Efforts
- Polyurethane firmly bonded to Precision Machined Aluminum Core
- Red Tread 80 Shore A (shown)
- Non-marking and floor protective

- Tread Options (specify by durometer):
70A Black
95A Blue
73D Orange
- Precision Ball Bearings
- Temperature Range: -40°F to +180°F



Part Number Swivel Caster	Part Number Swivel with Total Lock	Part Number Rigid Caster	Wheel Diameter (inch)	Tread Width (inch)	Load Capacity (lbs)	Overall Height (inch)	Swivel Radius (inch)	Swivel Radius w/Total Lock (inch)	Swivel Radius w/Wheel Brake (inch)
GHKU42SME80A	GHKU42SMETL80A	GHKU42RME80A	4	2	800	5-5/8	3-3/16	4	8-1/2
GHKU52SME80A	GHKU52SMETL80A	GHKU52RME80A	5	2	1000	6-1/2	3-7/8	4	9-1/2
GHKU62SME80A	GHKU62SMETL80A	GHKU62RME80A	6	2	1250	7-1/2	4-9/16	6	10
GHKU82SME80A	GHKU82SMETL80A	GHKU82RME80A	8	2	1500	9-1/2	6	6	11-1/2

SZS WHEELS

ELASTIC POLYURETHANE TREAD WHEELS CAST IRON CORE

- Polyurethane firmly bonded to Precision Machined Cast Iron Core
- 85+ 3 Shore A
- Excellent for power towing applications

- Reduced noise due to cushioning of loads, Lively Polyurethane allows wheels to "Flex and Roll" over debris
- Non-marking and floor protective
- Precision Ball Bearings
- Temperature Range: -40°F to +180°F
- **Available in Anti-Static add "AS" after wheel**



Part Number Swivel Caster	Part Number Swivel with Total Lock	Part Number Rigid Caster	Wheel Diameter (inch)	Tread Width (inch)	Load Capacity (lbs)	Overall Height (inch)	Swivel Radius (inch)	Swivel Radius w/Total Lock (inch)	Swivel Radius w/Wheel Brake (inch)
GHKU42SSZS	GHKU42SSZSTL	GHKU42RSZS	4	2	550	5-5/8	3-3/16	4	8-1/2
GHKU52SSZS	GHKU52SSZSTL	GHKU52RSZS	5	2	775	6-1/2	3-7/8	4	9-1/2
GHKU62SSZS	GHKU62SSZSTL	GHKU62RSZS	6	2	1000	7-1/2	4-9/16	6	10
GHKU82SSZS	GHKU82SSZSTL	GHKU82RSZS	8	2	1450	9-1/2	6	6	11-1/2

SEN
WHEELS

SOLID ELASTOMER WHEEL NYLON CORE

- 70 Shore (D) durometer
- FDA standards for use in food processing environments
- 100% washable

- Glass-filled nylon core insert endures heat
- High impact and abrasion resistant
- Resists oil, grease, water, and most solvents
- Temp Range: -50°F to +180°F



Part Number Swivel Caster	Part Number Swivel with Total Lock	Part Number Rigid Caster	Wheel Diameter (inch)	Tread Width (inch)	Load Capacity (lbs)	Overall Height (inch)	Swivel Radius (inch)	Swivel Radius w/Total Lock (inch)	Swivel Radius w/Wheel Brake (inch)
GHKU42SSEN	GHKU42SSENTL	GHKU42RSEN	4	2	1500	5-5/8	3-3/16	4	8-1/2
GHKU52SSEN	GHKU52SSENTL	GHKU52RSEN	5	2	1800	6-1/2	3-7/8	4	9-1/2
GHKU62SSEN	GHKU62SSENTL	GHKU62RSEN	6	2	2000	7-1/2	4-9/16	6	10
GHKU82SSEN	GHKU82SSENTL	GHKU82RSEN	8	2	2000	9-1/2	6	6	11-1/2

SJS WHEELS

POLYURETHANE TREAD WHEELS
CAST IRON CORE

- Polyurethane tread wheels firmly bonded to Precision Machined Cast Iron Core
- 93 + 3 Shore A
- Low rolling resistance; Smooth and noiseless running
- Non-marking and floor protective

- Good abrasion and cut resistance
- Ideal for medium duty applications
- Precision Ball Bearings
- Temperature Range: -40°F to +180°F
- Available in Anti-Static add "AS" after wheel

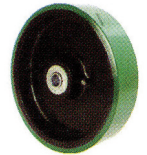

Part Number Swivel Caster	Part Number Swivel with Total Lock	Part Number Rigid Caster	Wheel Diameter (inch)	Tread Width (inch)	Load Capacity (lbs)	Overall Height (inch)	Swivel Radius (inch)	Swivel Radius w/Total Lock (inch)	Swivel Radius w/Wheel Brake (inch)
GHKU42SSJS	GHKU42SSJSTL	GHKU42RSJS	4	2	700	5-5/8	3-3/16	4	8-1/2
GHKU52SSJS	GHKU52SSJSTL	GHKU52RSJS	5	2	1000	6-1/2	3-7/8	4	9-1/2
GHKU62SSJS	GHKU62SSJSTL	GHKU62RSJS	6	2	1200	7-1/2	4-9/16	6	10
GHKU82SSJS	GHKU82SSJSTL	GHKU82RSJS	8	2	1500	9-1/2	6	6	11-1/2

MDW WHEELS

DUCTILE CAST STEEL WHEELS

- Machined tread face
- Crown tread face makes maneuverability easy
- Higher load capacities compared to cast iron wheels

- Suitable for extra heavy loads towed in punishing conditions
- High abrasion and oil resistance
- Precision Ball Bearings
- Temperature Range: 800°F

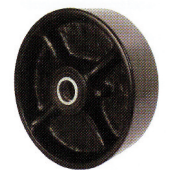

Part Number Swivel Caster	Part Number Swivel with Total Lock	Part Number Rigid Caster	Wheel Diameter (inch)	Tread Width (inch)	Load Capacity (lbs)	Overall Height (inch)	Swivel Radius (inch)	Swivel Radius w/Total Lock (inch)	Swivel Radius w/Wheel Brake (inch)
GHKU42SMDW	GHKU42SMDWTL	GHKU42RMDW	4	2	1500	5-5/8	3-3/16	4	8-1/2
GHKU52SMDW	GHKU52SMDWTL	GHKU52RMDW	5	2	1550	6-1/2	3-7/8	4	9-1/2
GHKU62SMDW	GHKU62SMDWTL	GHKU62RMDW	6	2	2000	7-1/2	4-9/16	6	10
GHKU82SMDW	GHKU82SMDWTL	GHKU82RMDW	8	2	2000	9-1/2	6	6	11-1/2

DF WHEELS

HOT FORGED STEEL WHEELS

- AISI 1045 steel with machined tread faces
- Virtually indestructible and easy to maneuver
- High abrasion and oil resistant

- Can be used in the roughest of applications on the poorest of floors
- Precision Ball Bearings
- Temperature Range: -150°F to +800°F

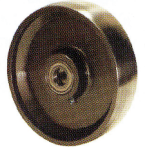

Part Number Swivel Caster	Part Number Swivel with Total Lock	Part Number Rigid Caster	Wheel Diameter (inch)	Tread Width (inch)	Load Capacity (lbs)	Overall Height (inch)	Swivel Radius (inch)	Swivel Radius w/Total Lock (inch)	Swivel Radius w/Wheel Brake (inch)
GHKU42SDF	GHKU42SDFTL	GHKU42RDF	4	2	1800	5-5/8	3-3/16	4	8-1/2
GHKU52SDF	GHKU52SDFTL	GHKU52RDF	5	2	2000	6-1/2	3-7/8	4	9-1/2
GHKU62SDF	GHKU62SDFTL	GHKU62RDF	6	2	2000	7-1/2	4-9/16	6	10
GHKU82SDF	GHKU82SDFTL	GHKU82RDF	8	2	2000	9-1/2	6	6	11-1/2

NY/MD WHEELS

NYLACRON™ WHEELS

- Precision Machined from Cast Polyamide. Hardness 112-120 Rockwell R
- Ultimate choice for extremely high load applications to replace metallic wheels
- Offer very high abrasion resistance and very low rolling resistance under extreme loads

- Resistant to salt, grease, alcohol and mild acids - can be used in corrosive applications with appropriate bearings
- Precision Ball Bearings
- Temperature Range: -40°F to +270°F

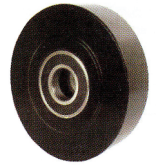

Part Number Swivel Caster	Part Number Swivel with Total Lock	Part Number Rigid Caster	Wheel Diameter (inch)	Tread Width (inch)	Load Capacity (lbs)	Overall Height (inch)	Swivel Radius (inch)	Swivel Radius w/Total Lock (inch)	Swivel Radius w/Wheel Brake (inch)
GHKU42SNYMD	GHKU42SNYMDTL	GHKU42RNYMD	4	2	2000	5-5/8	3-3/16	4	8-1/2
GHKU52SNYMD	GHKU52SNYMDTL	GHKU52RNYMD	5	2	2000	6-1/2	3-7/8	4	9-1/2
GHKU62SNYMD	GHKU62SNYMDTL	GHKU62RNYMD	6	2	2000	7-1/2	4-9/16	6	10
GHKU82SNYMD	GHKU82SNYMDTL	GHKU82RNYMD	8	2	2000	9-1/2	6	6	11-1/2

NY/MC WHEELS

NYLACRON™ WHITE WHEELS

- Precision Machined from cast polyamide hardness 112-120 Rockwell R
- Ultimate choice for extremely high load applications to replace metallic wheels
- Offer very high abrasion resistance and very low rolling resistance under extreme loads

- Resistant to salt, grease, alcohol and mild acids - can be used in corrosive applications with appropriate bearings
- Precision Ball Bearings
- Temperature Range: -40°F to +270°F



Part Number Swivel Caster	Part Number Swivel with Total Lock	Part Number Rigid Caster	Wheel Diameter (inch)	Tread Width (inch)	Load Capacity (lbs)	Overall Height (inch)	Swivel Radius (inch)	Swivel Radius w/Total Lock (inch)	Swivel Radius w/Wheel Brake (inch)
GHKU42SNYMC	GHKU42SNYMCTL	GHKU42RNYMC	4	2	2000	5-5/8	3-3/16	4	8-1/2
GHKU52SNYMC	GHKU52SNYMCTL	GHKU52RNYMC	5	2	2000	6-1/2	3-7/8	4	9-1/2
GHKU62SNYMC	GHKU62SNYMCTL	GHKU62RNYMC	6	2	2000	7-1/2	4-9/16	6	10
GHKU82SNYMC	GHKU82SNYMCTL	GHKU82RNYMC	8	2	2000	9-1/2	6	6	11-1/2

Swivel-EAZ™ Wheels available. Durometers: 70A (Black), 80A (Red), 95A (Blue), 60D (Gray), 75D (Black)

See pages 192-194 wheel section for complete specs on Swivel-EAZ™.