

4 27/FT/28 SERIES KINGPIN CASTERS

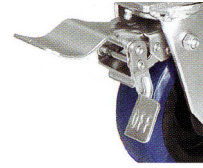

**FOOT OPERATED
FLOOR LOCK
4PSL27**



**DUAL PEDAL
TOTAL LOCK
DT***

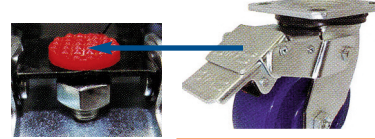

**FRONT DUAL PEDAL
ADJUSTABLE TOTAL
LOCKING CASTERS
FT***

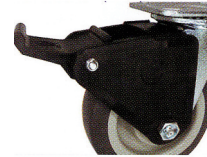

**TECH-LOCK
PEDAL BRAKE
H***

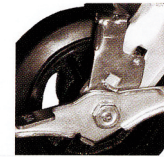

**TOP-LOCK
BRAKE
T***



**RACEWAY SEALS
Thermo - plastic
up to 140° F
L***

***ADD TO SWIVEL OR TOTAL LOCK RIGS.
ALL SWIVEL SECTIONS ARE SEALED.**

1,250 LBS. LOAD CAPACITY FORGED KINGPIN TYPE CASTERS

- Double ball raceway offer smooth swiveling action, strength and long service life.
- Standard 5/8" nut & bolt kingpin
- 1/4" thick cold rolled steel; designed, formed and welded for optimal mobility.
- Zinc plated finish is attractive & corrosion resistant.
- Zerk grease fitting in raceway & axle for maintenance.

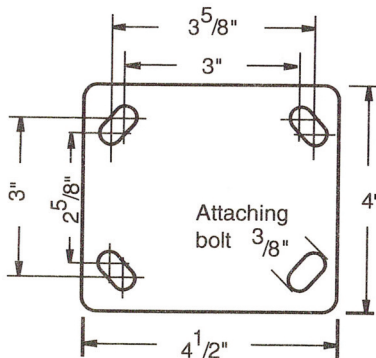

**STANDARD TOP PLATE
4 X 4-1/2**

**BOLT HOLE CENTER
2-5/8 X 3-5/8
SLOTTED TO 3 X 3**

**ATTACHING BOLT SIZE
3/8**

**OPTIONAL TOP PLATE 20
5 X 5-1/2**

**BOLT HOLE CENTER
4-1/8 X 4-1/2**

**ATTACHING BOLT SIZE
3/8**

**ALL WHEELS
AVAILABLE WITH
PRECISION
BALL BEARINGS
STANDARD**

4

27/FT/28 SERIES KINGPIN CASTERS

MU
WHEELS

POLYURETHANE ON GLASS-FILLED NYLON

- Polyurethane elastomer tread chemically bonded to an ultra-strong
- Offers a smooth effortless ride, is non-marking and protects floors
- Resist compression set or “flat spotting,” has exceptional impact strength and good abrasion resistance

- Non-metal materials will not rust
- Color: green
- Durometer: 95 Shore A +/-5
- Temp Range: -45°F to +180°F



Part Number Swivel Caster	Part Number Swivel with Total Lock*	Part Number Rigid Caster	Wheel Diameter (inch)	Tread Width (inch)	Load Capacity (lbs)	Overall Height (inch)	Swivel Radius (inch)	Swivel Radius w/Total Lock (inch)	Swivel Radius w/Wheel Brake (inch)
27MU40JN63	FTMU40JN63	28MU40JN63	4	2	700	5-5/8	3-3/16	4	8-1/2
27MU50JN63	FTMU50JN63	28MU50JN63	5	2	1000	6-1/2	3-7/8	4	9-1/2
27MU60JN63	FTMU60JN63	28MU60JN63	6	2	1200	7-1/2	4-9/16	6	10
27MU80JN63	FTMU80JN63	28MU80JN63	8	2	1400	9-1/2	6	6	11-1/2

PM
WHEELS

POLYURETHANE ON POLYOLEFIN

- High performance UV resistant, liquid cast polyurethane elastomer; mechanically locked onto an injection molded polyolefin core; takes more abuse and has a longer service life than standard PP wheels
- 1-1/4" wide wheels are maroon or gray, with sanitary style (no thread guards) dished out core and dual row annular ball bearings, offering improved mobility and stability

- Axle can be completely tightened without binding the bearings. 2" wide wheels have a dark gray tread on a grey core
- Durometer: 60 Shore D +/-5
- Temp Range: -45°F to +180°F

Optional

No seam style available (for upcharge): No seam on the wheel tread reduces the possibility of leaving indentations of soft floors (wood, linoleum, etc)



Part Number Swivel Caster	Part Number Swivel with Total Lock*	Part Number Rigid Caster	Wheel Diameter (inch)	Tread Width (inch)	Load Capacity (lbs)	Overall Height (inch)	Swivel Radius (inch)	Swivel Radius w/Total Lock (inch)	Swivel Radius w/Wheel Brake (inch)
27PM40JI63	FTPM40JI63	28PM40JI63	4	2	600	5-5/8	3-3/16	4	8-1/2
27PM50JI63	FTPM50JI63	28PM50JI63	5	2	750	6-1/2	3-7/8	4	9-1/2
27PM60JI63	FTPM60JI63	28PM60JI63	6	2	900	7-1/2	4-9/16	6	10
27PM80JI63	FTPM80JI63	28PM80JI63	8	2	1000	9-1/2	6	6	11-1/2

HU
WHEELS

HEAVY DUTY SOLID ELASTOMER WHEEL

- Super strength solid cast polyurethane elastomer one piece design with mechanically locked glass filled nylon bearing collar, offers the best durability and performance of any elastomer type wheel on the market
- Precision Ball Bearings
- 100% washable, steam cleanable, chemical resistant

- Extreme impact strength and abrasion and compression resistance, will not flat spot when used within capacity rating
- Offers a smooth ergonomic ride; easy start up
- Color: grey with black core/bearing collar
- Durometer: 68 Shore D +/-5
- Temp Range: -50°F to +180°F



Part Number Swivel Caster	Part Number Swivel with Total Lock*	Part Number Rigid Caster	Wheel Diameter (inch)	Tread Width (inch)	Load Capacity (lbs)	Overall Height (inch)	Swivel Radius (inch)	Swivel Radius w/Total Lock (inch)	Swivel Radius w/Wheel Brake (inch)
27HU40JI63	FTHU40JI63	28HU40JI63	4	2	1000	5-5/8	3-3/16	4	8-1/2
27HU50JI63	FTHU50JI63	28HU50JI63	5	2	1400	6-1/2	3-7/8	4	9-1/2
27HU60JI63	FTHU60JI63	28HU60JI63	6	2	1700	7-1/2	4-9/16	6	10
27HU80JI63	FTHU80JI63	28HU80JI63	8	2	2000	9-1/2	6	6	11-1/2

**SU
WHEELS****SOLID POLYURETHANE**

- Solid cast polyurethane elastomer one piece design eliminates bonding failures and is a very reliable and durable wheel
- 100% washable & steam cleanable; not affected by grease, oils, most chemicals & cleaning solutions, brine and blood
- Flanged Precision Ball Bearings

- Offers a smooth effortless ride, is non-marking and protects floors
- Resists compression set or “flat spotting,” has exceptional impact strength and is highly abrasion resistant
- Color: blue
- Durometer: 60 Shore D +/-5
- Temp Range: -50°F to +180°F



Part Number Swivel Caster	Part Number Swivel with Total Lock*	Part Number Rigid Caster	Wheel Diameter (inch)	Tread Width (inch)	Load Capacity (lbs)	Overall Height (inch)	Swivel Radius (inch)	Swivel Radius w/Total Lock (inch)	Swivel Radius w/Wheel Brake (inch)
27SU40JL60	FTSU40JL60	28SU40JL60	4	2	750	5-5/8	3-3/16	4	8-1/2
27SU50JL60	FTSU50JL60	28SU50JL60	5	2	900	6-1/2	3-7/8	4	9-1/2
27SU60JL60	FTSU60JL60	28SU60JL60	6	2	1000	7-1/2	4-9/16	6	10
27SU80JL60	FTSU80JL60	28SU80JL60	8	2	1000	9-1/2	6	6	11-1/2

**TP
WHEELS****THERMOPLASTIC RUBBER CROWN TREAD ON POLYOLEFIN CORE.**

- Non-marking thermoplastic rubber tread is permanently bonded to polyolefin core
- Shock absorbing cushioned ride offers floor protection and quiet rolling operation
- Offers good stability at low temperatures
- Resistant to cleaning chemicals, acids, alcohol, water, and is excellent for wash down applications & outdoor use, UV resistant

- Offers a smooth effortless ride, is non-marking and protects floors
- Flat tread wheels offer maximum durability at rated capacities; while round tread wheels offer an easy rolling ergonomic ride; reduced tread surface area also enables improved swiveling capabilities and turning mobility
- Color: grey or black tread
- Durometer: 75 Shore A +/-5
- Temp Range: -40°F to +180°F



Part Number Swivel Caster	Part Number Swivel with Total Lock*	Part Number Rigid Caster	Wheel Diameter (inch)	Tread Width (inch)	Load Capacity (lbs)	Overall Height (inch)	Swivel Radius (inch)	Swivel Radius w/Total Lock (inch)	Swivel Radius w/Wheel Brake (inch)
27TP40JX63	FTTP40JX63	28TP40JX63	4	2	300	5-5/8	3-3/16	4	8-1/2
27TP50JX63	FTTP50JX63	28TP50JX63	5	2	350	6-1/2	3-7/8	4	9-1/2
27TP60JX63	FTTP60JX63	28TP60JX63	6	2	500	7-1/2	4-9/16	6	10
27TP80JX63	FTTP80JX63	28TP80JX63	8	2	600	9-1/2	6	6	11-1/2

**TP
WHEELS****THERMOPLASTIC RUBBER FLAT TREAD ON POLYOLEFIN CORE.**

- Non-marking thermoplastic rubber tread is permanently bonded to polyolefin core
- Shock absorbing cushioned ride offers floor protection and quiet rolling operation
- Offers good stability at low temperatures
- Resistant to cleaning chemicals, acids, alcohol, water, and is excellent for wash down applications & outdoor use, UV resistant

- Offers a smooth effortless ride, is non-marking and protects floors
- Flat tread wheels offer maximum durability at rated capacities; while round tread wheels offer an easy rolling ergonomic ride; reduced tread surface area also enables improved swiveling capabilities and turning mobility
- Color: grey or black tread
- Durometer: 75 Shore A +/-5
- Temp Range: -40°F to +180°F



Part Number Swivel Caster	Part Number Swivel with Total Lock*	Part Number Rigid Caster	Wheel Diameter (inch)	Tread Width (inch)	Load Capacity (lbs)	Overall Height (inch)	Swivel Radius (inch)	Swivel Radius w/Total Lock (inch)	Swivel Radius w/Wheel Brake (inch)
27TP40JI63	FTTP40JI63	28TP40JI63	4	2	300	5-5/8	3-3/16	4	8-1/2
27TP50JI63	FTTP50JI63	28TP50JI63	5	2	350	6-1/2	3-7/8	4	9-1/2
27TP60JI63	FTTP60JI63	28TP60JI63	6	2	500	7-1/2	4-9/16	6	10
27TP80JI63	FTTP80JI63	28TP80JI63	8	2	600	9-1/2	6	6	11-1/2

4 27/FT/28 SERIES KINGPIN CASTERS

RA RUBBER MOLD ON ALUMINUM

WHEELS

- Rubber tread vulcanized to aluminum core
- Offer shock absorbing cushioned ride, rolls over debris, offers floor protection & quiet rolling operation

- Aluminum core has a strong attractive appearance, is lightweight and is resistant to rust and corrosion
- Color: grey or black tread
- Durometer: 80 Shore A +/-5
- Temp Range: -40°F to +160°F



Part Number Swivel Caster	Part Number Swivel with Total Lock*	Part Number Rigid Caster	Wheel Diameter (inch)	Tread Width (inch)	Load Capacity (lbs)	Overall Height (inch)	Swivel Radius (inch)	Swivel Radius w/Total Lock (inch)	Swivel Radius w/Wheel Brake (inch)
27RA40JB60	FT27RA40JB60	28RA40JB60	4	2	400	5-5/8	3-3/16	4	8-1/2
27RA50JB60	FT27RA50JB60	28RA50JB60	5	2	500	6-1/2	3-7/8	4	9-1/2
27RA60JB60	FT27RA60JB60	28RA60JB60	6	2	550	7-1/2	4-9/16	6	10

NR RUBBER ON GLASS-FILLED NYLON

WHEELS

- Soft rubber tread is molded over hard rubber core
- Shock absorbing cushioned ride and offers floor protection & quiet rolling operation
- Nylon bearing sleeve molded into wheel core, offers improved roll-ability

- Precision Ball Bearing Flanged.
- Color: black.
- Durometer: 80 Shore A +/-5
- Temp Range: -40°F to +180°F



Part Number Swivel Caster	Part Number Swivel with Total Lock*	Part Number Rigid Caster	Wheel Diameter (inch)	Tread Width (inch)	Load Capacity (lbs)	Overall Height (inch)	Swivel Radius (inch)	Swivel Radius w/Total Lock (inch)	Swivel Radius w/Wheel Brake (inch)
27NR40IB60	FTNR40IB60	28NR40IB60	4	2	400	5-5/8	3-3/16	4	8-1/2
27NR50IB60	FTNR50IB60	28NR50IB60	5	2	450	6-1/2	3-7/8	4	9-1/2
27NR60IB60	FTNR60IB60	28NR60IB60	6	2	550	7-1/2	4-9/16	6	10
27NR80IB60	FTNR80IB60	28NR80IB60	8	2	600	9-1/2	6	6	11-1/2

PU POLYURETHANE ON STEEL

WHEELS

- Polyurethane elastomer tread chemically bonded to cast iron core
- Offers higher weight capacities while providing good floor protection and quiet rolling operation
- Sealed Precision Ball Bearing with Top Hats

- Works well in both indoor and outdoor environments; however cast iron core can rust; if this is an issue, look at using aluminum wheels.
- Durometer: 95 Shore A +/-5
- Temp Range: -40°F to +180°F

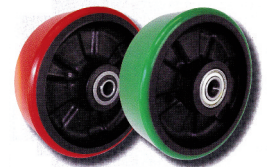

Part Number Swivel Caster	Part Number Swivel with Total Lock*	Part Number Rigid Caster	Wheel Diameter (inch)	Tread Width (inch)	Load Capacity (lbs)	Overall Height (inch)	Swivel Radius (inch)	Swivel Radius w/Total Lock (inch)	Swivel Radius w/Wheel Brake (inch)
27PU40JG63	FTPU40JG63	28PU40JG63	4	2	450	5-5/8	3-3/16	4	8-1/2
27PU40JG63	FTPU40JG63	28PU40JG63	5	2	500	6-1/2	3-7/8	4	9-1/2
27PU40JG63	FTPU40JG63	28PU40JG63	6	2	600	7-1/2	4-9/16	6	10
27PU40JG63	FTPU40JG63	28PU40JG63	8	2	700	9-1/2	6	6	11-1/2

**PO
WHEELS****POLYOLEFIN**

- Solid injection molded polyolefin wheel construction
- High shock load, impact & abrasion resistant
- Economical & lightweight, yet offer high weight capacities
- Sealed Precision Ball Bearing Flanged

- 100% washable; impervious to water, highly resistant to organic solvents, oil, grease, most chemicals, acids & cleaning solutions
- Color: black or white tread
- Durometer: 70 Shore D +/-5
- Temp Range: -40°F to +180°F



Part Number Swivel Caster	Part Number Swivel with Total Lock*	Part Number Rigid Caster	Wheel Diameter (inch)	Tread Width (inch)	Load Capacity (lbs)	Overall Height (inch)	Swivel Radius (inch)	Swivel Radius w/Total Lock (inch)	Swivel Radius w/Wheel Brake (inch)
27PO40JB60	FTPO40JB60	28PO40JB60	4	2	700	5-5/8	3-3/16	4	8-1/2
27PO50JB60	FTPO50JB60	28PO50JB60	5	2	900	6-1/2	3-7/8	4	9-1/2
27PO60JB60	FTPO60JB60	28PO60JB60	6	2	1000	7-1/2	4-9/16	6	10
27PO80JB60	FTPO80JB60	28PO80JB60	8	2	1200	9-1/2	6	6	11-1/2

**PA
WHEELS****POLYURETHANE ON ALUMINUM FLAT TREAD**

- Polyurethane elastomer tread chemically bonded to a light-weight aluminum core
- Aluminum core has a strong attractive appearance, is lightweight and is resistant to rust and corrosion
- Sealed Precision Ball Bearing Flanged

- 100% washable; impervious to water, highly resistant to organic solvents, oil, grease, most chemicals, acids & cleaning solutions
- Color: red, green & blue
- Durometer: 95 Shore A +/-5
- Temp Range: -40°F to +180°F

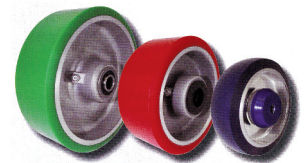

Part Number Swivel Caster	Part Number Swivel with Total Lock*	Part Number Rigid Caster	Wheel Diameter (inch)	Tread Width (inch)	Load Capacity (lbs)	Overall Height (inch)	Swivel Radius (inch)	Swivel Radius w/Total Lock (inch)	Swivel Radius w/Wheel Brake (inch)
27PA40JN60	FTPA40JN60	28PA40JN60	4	2	800	5-5/8	3-3/16	4	8-1/2
27PA50JN60	FTPA50JN60	28PA50JN60	5	2	900	6-1/2	3-7/8	4	9-1/2
27PA60JN60	FTPA60JN60	28PA60JN60	6	2	1200	7-1/2	4-9/16	6	10
27PA80JN60	FTPA80JN60	28PA80JN60	8	2	1500	9-1/2	6	6	11-1/2

**MA
WHEELS****NYLON GLASS-FILLED**

- Injection molded, 30% glass filled nylon wheel; has the same weight capacity of steel, yet incredibly light-weight
- 100% washable & steam cleanable, not affected by grease, oil, most chemicals & cleaning solutions, salt, brine & blood
- Sealed Precision Ball Bearing with Top Hat Bushings

- Extreme impact strength, good abrasion and compression resistance, will not flat spot.
- Offers a smooth ergonomic ride; requires less effort to start up and maintain a rolling load
- Durometer: 85 Shore D +/-5
- Temp Range: -40°F to +250°F

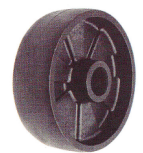

Part Number Swivel Caster	Part Number Swivel with Total Lock*	Part Number Rigid Caster	Wheel Diameter (inch)	Tread Width (inch)	Load Capacity (lbs)	Overall Height (inch)	Swivel Radius (inch)	Swivel Radius w/Total Lock (inch)	Swivel Radius w/Wheel Brake (inch)
27MA40JB63	FTMA40JB63	28MA40JB63	4	2	800	5-5/8	3-3/16	4	8-1/2
27MA50JB63	FTMA50JB63	28MA50JB63	5	2	1000	6-1/2	3-7/8	4	9-1/2
27MA60JB63	FTMA60JB63	28MA60JB63	6	2	1200	7-1/2	4-9/16	6	10
27MA80JB63	FTMA80JB63	28MA80JB63	8	2	1250	9-1/2	6	6	11-1/2

**BC
WHEELS****RUBBER ON ALUMINUM**

- High modulus quality rubber tread vulcanized to aluminum core
- Rounded balloon cushion tread offers the best shock absorbing cushioned ride available, easily rolls over debris and small obstructions (electrical cords, floor joint, etc), offers maximum floor protection, high impact strength and ultra quiet rolling operation

- Sealed Precision Ball Bearing with Top Hat Bushings
- High modulus round tread minimizes surface friction and enables wheel to turn easily
- Gray or black tread colors are available; gray tread is non-marking
- Durometer: 60 Shore A +/-5
- Temp Range: -40°F to +180°F

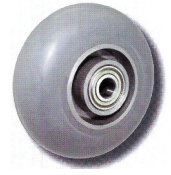

Part Number Swivel Caster	Part Number Swivel with Total Lock*	Part Number Rigid Caster	Wheel Diameter (inch)	Tread Width (inch)	Load Capacity (lbs)	Overall Height (inch)	Swivel Radius (inch)	Swivel Radius w/Total Lock (inch)	Swivel Radius w/Wheel Brake (inch)
27BC60J63	FTBC60J63	28BC60J63	6	2	350	7-1/2	4-9/16	6	10
27BC80J63	FTBC80J63	28BC80J63	8	2	450	9-1/2	6	6	11-1/2

**UA
WHEELS****RUBBER ON ALUMINUM**

- Uniquely formulated "Flex Compound" polyurethane elastomer is chemically and mechanically bonded to a precision aluminum core; double bonding helps prevent tread separation and assures reliable mobility
- Combination of the round tread and sealed precision ball bearings minimizes surface friction, enables wheel to turn easily and requires less effort to startup and maintain a rolling load

- Sealed Precision Ball Bearing with Top Hat Bushings
- Offers a semi-cushioned ride, is non-marking and is capable of rolling over debris (metal shavings, door & floor joints, etc.)
- Great for manual or power assisted (towline) applications
- Durometer: 85 Shore A +/-5
- Temp Range: -40°F to +180°F



Part Number Swivel Caster	Part Number Swivel with Total Lock*	Part Number Rigid Caster	Wheel Diameter (inch)	Tread Width (inch)	Load Capacity (lbs)	Overall Height (inch)	Swivel Radius (inch)	Swivel Radius w/Total Lock (inch)	Swivel Radius w/Wheel Brake (inch)
27UA60JN63	FTUA60JN63	28UA60JN63	6	2	900	7-1/2	4-9/16	6	10
27UA80JN63	FTUA80JN63	28UA80JN63	8	2	1000	9-1/2	6	6	11-1/2

**CP
WHEELS****POLYURETHANE ON ELASTOMER TREAD**

- 1-3/16" thick ultra-flex compound polyurethane elastomer tread chemically bonded to a mag style aluminum core, sets a new standard in high quality wheels; maximizing load capacity, shock load, and vibration stabilization
- Combination of the thick ultra-flex tread and oversized sealed precision ball bearings minimizes rolling resistance

- Sealed Precision Ball Bearing with Top Hat Bushings
- Elastic properties of ultra-flex tread provide excellent abrasion resistance and a cushioned ride that easily rolls over debris and small obstructions. Offers maximum floor protection, high impact strength and ultra quiet rolling operation
- Great for manual or power assisted applications
- Color: green
- Durometer: 70 Shore A +/-5
- Temp Range: -40°F to +180°F



Part Number Swivel Caster	Part Number Swivel with Total Lock*	Part Number Rigid Caster	Wheel Diameter (inch)	Tread Width (inch)	Load Capacity (lbs)	Overall Height (inch)	Swivel Radius (inch)	Swivel Radius w/Total Lock (inch)	Swivel Radius w/Wheel Brake (inch)
27CP60JN64	FTCP60JN64	28CP60JN64	6	2	1200	7-1/2	4-9/16	6	10
27CP80JN64	FTCP80JN64	28CP80JN64	8	2	1500	9-1/2	6	6	11-1/2

**PH
WHEELS****PHENOLIC**

- Phenolic resin mixed with macerated canvas; creates a high capacity, high impact resistant wheel that has many years of proven reliability in the industry
- Hard tread rolls easily, provides good concrete floor protection and is quieter than steel wheels
- Sealed Precision Ball Bearing Flanged

- Resistant to oil, grease & solvents, non-metallic and non-sparking
- Economically priced wheel
- Zerk fitting are not standard, but available upon request
- Durometer: 90 Shore D +/-5
- Temp Range: -50°F to +250°F



Part Number Swivel Caster	Part Number Swivel with Total Lock*	Part Number Rigid Caster	Wheel Diameter (inch)	Tread Width (inch)	Load Capacity (lbs)	Overall Height (inch)	Swivel Radius (inch)	Swivel Radius w/Total Lock (inch)	Swivel Radius w/Wheel Brake (inch)
27PH34JB60	FTPH34JB60	28PH34JB60	3-1/4	2	700	4-1/4	1-3/4	4	8-1/2
27PH40JB60	FTPH40JB60	28PH40JB60	4	2	800	5-5/8	3-3/16	4	8-1/2
27PH50JB60	FTPH50JB60	28PH50JB60	5	2	1000	6-1/2	3-7/8	4	9-1/2
27PH60JB60	FTPH60JB60	28PH60JB60	6	2	1200	7-1/2	4-9/16	6	10
27PH80JB60	FTPH80JB60	28PH80JB60	8	2	1250	9-1/2	6	6	11-1/2

HI-TEMP PHENOLIC +550°F intermittent (part# TPH)

- Stainless Steel Roller Bearing.

Part Number Swivel Caster	Part Number Swivel with Total Lock*	Part Number Rigid Caster	Wheel Diameter (inch)	Tread Width (inch)	Load Capacity (lbs)	Overall Height (inch)	Swivel Radius (inch)	Swivel Radius w/Total Lock (inch)	Swivel Radius w/Wheel Brake (inch)
27HT40JB05	FTHT40JB05	28HT40JB05	4	2	800	5-5/8	3-3/16	4	8-1/2
27HT50JB05	FTHT50JB05	28HT50JB05	5	2	1000	6-1/2	3-7/8	4	9-1/2
27HT60JB05	FTHT60JB05	28HT60JB05	6	2	1200	7-1/2	4-9/16	6	10
27HT80JB05	FTHT80JB05	28HT80JB05	8	2	1250	9-1/2	6	6	11-1/2

**SW
WHEELS****POLYURETHANE ON ELASTOMER TREAD**

- Crowned polyurethane elastomer tread chemically bonded to a solid heavy-duty cast iron core
- Combination of crowned tread and heavy core, offers higher weight capacities, durability and greater mobility
- Sealed Precision Ball Bearings

- Provides good floor protection and quiet rolling operation
- Color: dark blue on black
- Durometer: 95 Shore D +/-5
- Temp Range: -40°F to +180°F



Part Number Swivel Caster	Part Number Swivel with Total Lock*	Part Number Rigid Caster	Wheel Diameter (inch)	Tread Width (inch)	Load Capacity (lbs)	Overall Height (inch)	Swivel Radius (inch)	Swivel Radius w/Total Lock (inch)	Swivel Radius w/Wheel Brake (inch)
27SW60JU63	FTSW60JU63	28SW60JU63	6	2	1400	7-1/2	4-9/16	6	10
27SW80JU63	FTSW80JU63	28SW80JU63	8	2	1500	9-1/2	6	6	11-1/2

4 27/FT/28 SERIES KINGPIN CASTERS

RP WHEELS

ROUND TREAD POLYURETHANE ON CAST IRON CORE

- Uniquely formulated “Flex Compound” polyurethane elastomer is chemically bonded to heavy cast iron core
- Combination of the round tread and sealed precision ball bearings minimizes surface friction, enables wheel to turn easily and requires less effort to startup and maintain a rolling load

- Sealed Precision Ball Bearing with Top Hat Bushings
- Offers a semi-cushioned ride, is non-marking and is capable of rolling over debris (metal shavings, door & floor joints, etc.)
- Color: gray & black.
- Durometer: 80 Shore A +/-5
- Temp Range: -40°F to +180°F



Part Number Swivel Caster	Part Number Swivel with Total Lock*	Part Number Rigid Caster	Wheel Diameter (inch)	Tread Width (inch)	Load Capacity (lbs)	Overall Height (inch)	Swivel Radius (inch)	Swivel Radius w/Total Lock (inch)	Swivel Radius w/Wheel Brake (inch)
27RP40JK63	FTRP40JK63	28RP40JK63	4	2	700	5-5/8	3-3/16	4	8-1/2
27RP50JK63	FTRP50JK63	28RP50JK63	5	2	800	6-1/2	3-7/8	4	9-1/2
27RP60JK63	FTRP60JK63	28RP60JK63	6	2	900	7-1/2	4-9/16	6	10
27RP80JK63	FTRP80JK63	28RP80JK63	8	2	1000	9-1/2	6	6	11-1/2

RH WHEELS

SUPREME RUBBER ON CAST IRON CORE

- High quality supreme rubber tread with a tensile strength of 1200 to 1400 PSI, vulcanized to a solid heavy duty cast iron core
- Upgraded tread material, core design and bearings; provide the perfect combination needed for use on tow lines and other demanding applications that normal mold-on rubber wheels may not be able to withstand

- Sealed Precision Ball Bearing with Top Hat Bushings
- Offers a shock absorbing semi-cushioned ride, rolls over small debris, uneven surfaces, cracks floor joints, etc
- Provides good floor protection and quiet rolling operation
- Durometer: 75 Shore A +/-5
- Temp Range: -40°F to +180°F



Part Number Swivel Caster	Part Number Swivel with Total Lock*	Part Number Rigid Caster	Wheel Diameter (inch)	Tread Width (inch)	Load Capacity (lbs)	Overall Height (inch)	Swivel Radius (inch)	Swivel Radius w/Total Lock (inch)	Swivel Radius w/Wheel Brake (inch)
27RH60JS63	FTRH60JS63	28RH60JS63	6	2	700	7-1/2	4-9/16	6	10
27RH80JS63	FTRH80JS63	28RH80JS63	8	2	800	9-1/2	6	6	11-1/2