

**Caster Type****Page**

GHKU LTP Kingpinless Casters2-5

KDW Dual Wheel Kingpinless Casters.....6-7

**ALL WHEELS ARE AVAILABLE WITH
PRECISION BALL BEARING, CENTERPIECE & END CAPS
FOR MANUAL OR TOWING TO FIT IN 2-1/2" HUB LENGTH RIGS.
See Wheel Section for complete selection.**

GHKU LTP SERIES KINGPINLESS CASTERS



**LEADING SIDE
TOTAL LOCK SWIVEL CASTER**
Add TL to swivel caster number

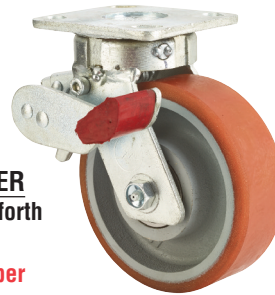

**NEW TRAILING SIDE
TOTAL LOCK SWIVEL CASTER**
No need to move cots back and forth
for finding the brake pedal.
Add TLN to swivel caster number



Specify Toe Guard
TO

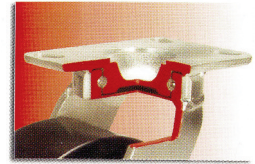

Swivel Head Section

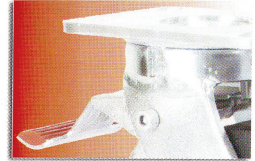

Total Lock System

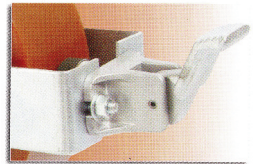

Wheel Face Brake

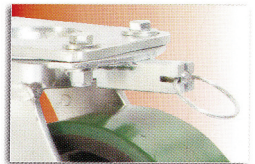

Directional Lock

2,000 LBS. LOAD CAPACITY FORGED KINGPINLESS TYPE CASTERS

- Single piece Drop Forged AISI 1045 Steel Top Plate and Fork Base.
- Precision CNC Machined Raceways with Kingpinless construction.
- Induction Hardening of Raceways ensures uniform depth of hardness.
- Totally Sealed Swivel Head with Grease Nipple.
- 1/4" Thick Fork Legs robotically welded Inside & Outside to 2 1/2" fork spacing.
- 1/2" Wheel axle.
- 4 Position Directional Lock Slots.
- Finish: Bright Zinc Plated.

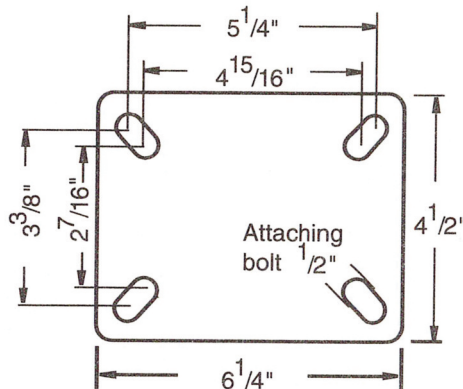

TOP PLATE
4-1/2 X 6-1/4

BOLT HOLE CENTER
3-3/8 X 5-1/4

SLOTTED TO
2-7/16 X 4-15/16

ATTACHING BOLT SIZE
1/2

RIG OPTIONS
DL: 4-WAY DIRECTIONAL LOCK
WFB: WHEEL FACE BRAKE
ADD TO SUFFIX
OF THE CASTER PART NUMBER

NY/MD WHEELS

NYLACRON™ WHEELS

- Precision Machined from Cast Polyamide Hardness 112-120 Rockwell R.
- Ultimate choice for Extremely High Load applications to replace metallic wheels.
- Offer very high abrasion resistance and very low rolling resistance under extreme loads.

- Resistant to salt, grease, alcohol and mild acids - can be used in corrosive applications with appropriate bearings.
- Precision Ball Bearings.
- Temperature Range: -40°F to +270°F.



Part Number Swivel Caster	Part Number Swivel with Total Lock	Part Number Rigid Caster	Wheel Diameter (inch)	Tread Width (inch)	Load Capacity (lbs)	Overall Height (inch)	Swivel Radius (inch)	Swivel Radius w/Total Lock (inch)	Swivel Radius w/Wheel Brake (inch)
GHKULTPS42NYMD	GHKULTPTL42NYMD	GHKULTPR42NYMD	4	2	2000	5-5/8	3-3/16	4	8-1/2
GHKULTPS52NYMD	GHKULTPTL52NYMD	GHKULTPR52NYMD	5	2	2000	6-1/2	3-7/8	4	9-1/2
GHKULTPS62NYMD	GHKULTPTL62NYMD	GHKULTPR62NYMD	6	2	2000	7-1/2	4-9/16	6	10
GHKULTPS82NYMD	GHKULTPTL82NYMD	GHKULTPR82NYMD	8	2	2000	9-1/2	6	6	11-1/2

NY/MC WHEELS

NYLACRON™ WHITE WHEELS

- Precision Machined from Cast Polyamide. Hardness 112-120 Rockwell R.
- Ultimate choice for Extremely High Load applications to replace metallic wheels.
- Offer very high abrasion resistance and very low rolling resistance under extreme loads.

- Resistant to salt, grease, alcohol and mild acids - can be used in corrosive applications with appropriate bearings.
- Precision Ball Bearings.
- Temperature Range: -40°F to +270°F.



Part Number Swivel Caster	Part Number Swivel with Total Lock	Part Number Rigid Caster	Wheel Diameter (inch)	Tread Width (inch)	Load Capacity (lbs)	Overall Height (inch)	Swivel Radius (inch)	Swivel Radius w/Total Lock (inch)	Swivel Radius w/Wheel Brake (inch)
GHKULTPS42NYMC	GHKULTPTL42NYMC	GHKULTPR42NYMC	4	2	2000	5-5/8	3-3/16	4	8-1/2
GHKULTPS52NYMC	GHKULTPTL52NYMC	GHKULTPR52NYMC	5	2	2000	6-1/2	3-7/8	4	9-1/2
GHKULTPS62NYMC	GHKULTPTL62NYMC	GHKULTPR62NYMC	6	2	2000	7-1/2	4-9/16	6	10
GHKULTPS82NYMC	GHKULTPTL82NYMC	GHKULTPR82NYMC	8	2	2000	9-1/2	6	6	11-1/2

KR WHEELS

KRYTONIC™ WHEELS

- Excellent carrying capacity.
- Slight crown shape affords an easy-rolling quiet operation.
- Greater service life and resistance to chunking, cutting and abrasive wear.

- 100% washable, steam cleanable, and resistant to most chemicals.
- Non-marking tread.
- Durometer: 58 Shore D (+/-5).
- Stainless Steel Precision Ball Bearings.
- Temperature Range: + 250°F for up to a 1/2 hour.

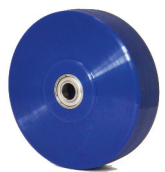

Part Number Swivel Caster	Part Number Swivel with Total Lock	Part Number Rigid Caster	Wheel Diameter (inch)	Tread Width (inch)	Load Capacity (lbs)	Overall Height (inch)	Swivel Radius (inch)	Swivel Radius w/Total Lock (inch)	Swivel Radius w/Wheel Brake (inch)
GHKULTPS42KR	GHKULTPTL42KR	GHKULTPR42KR	4	2	850	5-5/8	3-3/16	4	8-1/2
GHKULTPS52KR	GHKULTPTL52KR	GHKULTPR52KR	5	2	1100	6-1/2	3-7/8	4	9-1/2
GHKULTPS62KR	GHKULTPTL62KR	GHKULTPR62KR	6	2	1500	7-1/2	4-9/16	6	10
GHKULTPS82KR	GHKULTPTL82KR	GHKULTPR82KR	8	2	1750	9-1/2	6	6	11-1/2

SAS WHEELS

HIGH CAPACITY POLYURETHANE
TREAD WHEEL CAST IRON CORE

- Polyurethane firmly bonded to Precision Machined Cast Iron Core.
- 93+ 3 Shore A.
- Low rolling resistance, smooth and noiseless running.

- Non-marking and floor protective.
- High abrasion, cut and tear resistant.
- Precision Ball Bearings.
- Temperature Range: -40°F to +180°F.
- **Available in Anti-Static add "AS" after wheel.**



Part Number Swivel Caster	Part Number Swivel with Total Lock	Part Number Rigid Caster	Wheel Diameter (inch)	Tread Width (inch)	Load Capacity (lbs)	Overall Height (inch)	Swivel Radius (inch)	Swivel Radius w/Total Lock (inch)	Swivel Radius w/Wheel Brake (inch)
GHKULTPS42SAS	GHKULTPTL42SAS	GHKULTPR42SAS	4	2	900	5-5/8	3-3/16	4	8-1/2
GHKULTPS52SAS	GHKULTPTL52SAS	GHKULTPR52SAS	5	2	1200	6-1/2	3-7/8	4	9-1/2
GHKULTPS62SAS	GHKULTPTL62SAS	GHKULTPR62SAS	6	2	1650	7-1/2	4-9/16	6	10
GHKULTPS82SAS	GHKULTPTL82SAS	GHKULTPR82SAS	8	2	2000	9-1/2	6	6	11-1/2

ME WHEELS

ERGONOMIC POLYURETHANE
DONUT TREAD WHEEL CAST IRON CORE

- For Low Push-Pull Efforts.
- Polyurethane firmly bonded to Precision Machined Cast Iron Core.
- Red Tread 93+ 3 Shore A.
- Non-marking and floor protective.

- Tread Options:
Softer 80A - Yellow Tread (specify ME-Z)
Harder 73D - Blue Tread (specify ME-F).
- Precision Ball Bearings.
- Temperature Range: -40°F to +180°F.
- **Available in Anti-Static add "AS" after wheel.**



Part Number Swivel Caster	Part Number Swivel with Total Lock	Part Number Rigid Caster	Wheel Diameter (inch)	Tread Width (inch)	Load Capacity (lbs)	Overall Height (inch)	Swivel Radius (inch)	Swivel Radius w/Total Lock (inch)	Swivel Radius w/Wheel Brake (inch)
GHKULTPS42ME	GHKULTPTL42ME	GHKULTPR42ME	4	2	775	5-5/8	3-3/16	4	8-1/2
GHKULTPS52ME	GHKULTPTL52ME	GHKULTPR52ME	5	2	1000	6-1/2	3-7/8	4	9-1/2
GHKULTPS62ME	GHKULTPTL62ME	GHKULTPR62ME	6	2	1250	7-1/2	4-9/16	6	10
GHKULTPS82ME	GHKULTPTL82ME	GHKULTPR82ME	8	2	1700	9-1/2	6	6	11-1/2

SZS WHEELS

ELASTIC POLYURETHANE TREAD WHEELS

- Polyurethane firmly bonded to Precision Machined Cast Iron Core.
- 85 + 3 Shore A.
- Reduced noise due to cushioning of loads, Lively Polyurethane allows wheels to "Flex and Roll" over debris.

- Excellent for power towing applications.
- Non-marking and floor protective.
- Precision Ball Bearings.
- Temperature Range: -40°F to +180°F.
- **Available in Anti-Static add "AS" after wheel**



Part Number Swivel Caster	Part Number Swivel with Total Lock	Part Number Rigid Caster	Wheel Diameter (inch)	Tread Width (inch)	Load Capacity (lbs)	Overall Height (inch)	Swivel Radius (inch)	Swivel Radius w/Total Lock (inch)	Swivel Radius w/Wheel Brake (inch)
GHKULTPS42SZS	GHKULTPTL42SZS	GHKULTPR42SZS	4	2	550	5-5/8	3-3/16	4	8-1/2
GHKULTPS52SZS	GHKULTPTL52SZS	GHKULTPR52SZS	5	2	775	6-1/2	3-7/8	4	9-1/2
GHKULTPS62SZS	GHKULTPTL62SZS	GHKULTPR62SZS	6	2	1000	7-1/2	4-9/16	6	10
GHKULTPS62SZS	GHKULTPTL62SZS	GHKULTPR62SZS	8	2	1450	9-1/2	6	6	11-1/2

DF WHEELS

DROP FORGED STEEL WHEELS

- AISI 1045 steel with machined tread faces.
- Virtually indestructible and easy to maneuver.
- High abrasion and oil resistant.

- Can be used in the roughest of applications on the poorest of floors.
- Precision Ball Bearings.
- Temperature Range: -150°F to +800°F.



Part Number Swivel Caster	Part Number Swivel with Total Lock	Part Number Rigid Caster	Wheel Diameter (inch)	Tread Width (inch)	Load Capacity (lbs)	Overall Height (inch)	Swivel Radius (inch)	Swivel Radius w/Total Lock (inch)	Swivel Radius w/Wheel Brake (inch)
GHKULTPS42DF	GHKULTPTL42DF	GHKULTPR42DF	4	2	1800	5-5/8	3-3/16	4	8-1/2
GHKULTPS52DF	GHKULTPTL52DF	GHKULTPR52DF	5	2	2000	6-1/2	3-7/8	4	9-1/2
GHKULTPS62DF	GHKULTPTL62DF	GHKULTPR62DF	6	2	2000	7-1/2	4-9/16	6	10
GHKULTPS82DF	GHKULTPTL82DF	GHKULTPR82DF	8	2	2000	9-1/2	6	6	11-1/2

SJS WHEELS

POLYURETHANE TREAD WHEELS CAST IRON CORE

- Polyurethane tread wheels firmly bonded to Precision Machined Cast Iron Core.
- 93 + 3 Shore A.
- Low rolling resistance; Smooth and noiseless running.
- Non-marking and floor protective.

- Good abrasion and cut resistance.
- Ideal for medium duty applications.
- Precision Ball Bearings.
- Temperature Range: -40°F to +180°F.
- **Available in Anti-Static add "AS" after wheel.**

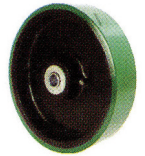

Part Number Swivel Caster	Part Number Swivel with Total Lock	Part Number Rigid Caster	Wheel Diameter (inch)	Tread Width (inch)	Load Capacity (lbs)	Overall Height (inch)	Swivel Radius (inch)	Swivel Radius w/Total Lock (inch)	Swivel Radius w/Wheel Brake (inch)
GHKULTPS42SJS	GHKULTPTL42SJS	GHKULTPR42SJS	4	2	700	5-5/8	3-3/16	4	8-1/2
GHKULTPS52SJS	GHKULTPTL52SJS	GHKULTPR52SJS	5	2	1000	6-1/2	3-7/8	4	9-1/2
GHKULTPS62SJS	GHKULTPTL62SJS	GHKULTPR62SJS	6	2	1200	7-1/2	4-9/16	6	10
GHKULTPS82SJS	GHKULTPTL82SJS	GHKULTPR82SJS	8	2	1500	9-1/2	6	6	11-1/2

MDW WHEELS

DUCTILE CAST STEEL WHEELS

- Machined tread face.
- Crown tread face makes maneuverability easy.
- Higher load capacities compared to Cast Iron wheels.

- Suitable for extra heavy loads towed in punishing conditions.
- High abrasion and oil resistance.
- Precision Ball Bearings.
- Temperature Range: 800°F.



Part Number Swivel Caster	Part Number Swivel with Total Lock	Part Number Rigid Caster	Wheel Diameter (inch)	Tread Width (inch)	Load Capacity (lbs)	Overall Height (inch)	Swivel Radius (inch)	Swivel Radius w/Total Lock (inch)	Swivel Radius w/Wheel Brake (inch)
GHKULTPS42MDW	GHKULTPTL42MDW	GHKULTPR42MDW	4	2	1500	5-5/8	3-3/16	4	8-1/2
GHKULTPS52MDW	GHKULTPTL52MDW	GHKULTPR52MDW	5	2	1550	6-1/2	3-7/8	4	9-1/2
GHKULTPS62MDW	GHKULTPTL62MDW	GHKULTPR62MDW	6	2	2000	7-1/2	4-9/16	6	10
GHKULTPS82MDW	GHKULTPTL82MDW	GHKULTPR82MDW	8	2	2000	9-1/2	6	6	11-1/2



3,500 LBS. LOAD CAPACITY KINGPINLESS TYPE CASTERS

- **Raceway Design:** Patented Kingpinless single ball bearing precision machined raceway hardened to 53 Rockwell C minimum. Swivel section features a 3" diameter raceway with 1/2" ball bearings. The notched yoke is standard.
- **Finish:** Bright Zinc Plated.
- **Yoke Base:** Notched 316 stainless steel.
- **Legs:** 5/16" formed steel. Center leg support is added for increased strength.
- **Wheels:** All wheels are 2" wide with 3/4" I.D. roller bearings that are prelubricated and rotate on individual spanner bushings or annular ball bearings for ease of rollability.
- **Axle:** 1/2" bolt, locking nut and lubrication fittings.
- Alternate or custom caster configurations available.

MOUNTING PLATE OPTIONS

TOP PLATE: (STANDARD)

Plate Size: 4-1/2" x 6-1/4"

Bolt Holes: 2-7/16" x 4-15/16"
slotted to
3-3/8" x 5-1/4"

Bolt Size: 1/2"

BRAKE OPTIONS

CWB Cam Wheel Brake

SWIVEL RIG OPTIONS

HT High Temperature Lubrication

LT Low Temperature Lubrication

DSL Demountable Swivel Lock

SL Swivel Lock

SR Sealed Swivel Raceway

TG Thread Guard

To order a rigid caster, change the "S" to "R" in the model number. Dimensions shown are nominal. If precise dimensions are required, consult Acorn™. For approximate weight of our rigid casters, deduct 3.9 pounds.

BEARING OPTIONS

Straight Roller **(01)**

Tapered Roller **(09)**

Precision Ball **(28)**

Wheel Type (Wheel Code)	Diameter (inch)	Width (inch)	Capacity (lbs.)	OAH (inch)	Swivel Lead (inch)	Approx. Wt. (lbs.)	Swivel Part Number Add B, P, PL, R or T*
CAST IRON (CA) WHEELS WITH ROLLER BEARINGS							
	5	2	2000	7-1/2	1-7/16	17	GHKUDWCAR52S*
	6	2	2400	8	1-7/16	18-1/2	GHKUDWCAR62S*
	8	2	2800	10-1/8	2-1/16	23	GHKUDWCAR82S*
NYLACRON™ MD (NY/MD) WHEELS WITH PRECISION BALL BEARINGS							
	5	2	2100	7-1/2	1-7/16	11-1/2	GHKUDWNYMDP52S*
	6	2	2200	8	1-7/16	12-1/2	GHKUDWNYMDP62S*
	8	2	2400	10-1/8	2-1/16	15	GHKUDWNYMDP82S*
PHENOLIC / TEXITE (TM) WHEELS WITH ROLLER BEARINGS							
	5	2	2000	7-1/2	1-7/16	11-1/2	GHKUDWTMR52S*
	6	2	2400	8	1-7/16	12-1/2	GHKUDWTMR62S*
	8	2	2800	10-1/8	2-1/16	15	GHKUDWTMR82S*
SWIVEL-EAZ™ (DUAL-IN-ONE) 95A / FLAT TREAD (SWE/9/FT) WHEELS WITH PRECISION BEARINGS (ALSO AVAILABLE IN CROWN TREAD)							
	5	2	1400	7-1/2	1-7/16	12-1/2	GHKUDWSWE9FTP52S*
	6	2	1900	8	1-7/16	13-1/2	GHKUDWSWE9FTP62S*
	8	2	3000	10-1/8	2-1/16	16	GHKUDWSWE9FTP82S*
SWIVEL-EAZ™ (DUAL-IN-ONE) 80A / FLAT TREAD (SWE/8/FT) WHEELS WITH PRECISION BEARINGS (ALSO AVAILABLE CROWN TREAD)							
	5	2	1050	7-1/2	1-7/16	12-1/2	GHKUDWSWE8FTP52S*
	6	2	1400	8	1-7/16	13-1/2	GHKUDWSWE8FTP62S*
	8	2	2300	10-1/8	2-1/16	16	GHKUDWSWE8FTP82S*
SWIVEL-EAZ™ (DUAL-IN-ONE) 60D / FLAT TREAD (SWE/6/FT) WHEELS WITH PRECISION BEARINGS (ALSO AVAILABLE IN CROWN TREAD)							
	5	2	1550	7-1/2	1-7/16	12-1/2	GHKUDWSWE6FTP52S*
	6	2	2200	8	1-7/16	13-1/2	GHKUDWSWE6FTP62S*
	8	2	3500	10-1/8	2-1/16	16	GHKUDWSWE6FTP82S*
URETHANE / DONUT TREAD / CAST IRON CORE (ME) WHEELS WITH PRECISION ALL BEARINGS							
	5	2	2000	7-1/2	1-7/16	15-1/2	GHKUDWME52S*
	6	2	2500	8	1-7/16	16-1/2	GHKUDWME62S*
	8	2	3400	10-1/8	2-1/16	17-1/2	GHKUDWME823S*
URETHANE / CAST IRON CORE (SJS) WHEELS WITH PRECISION BALL BEARINGS							
	5	2	2100	7-1/2	1-7/16	16-1/2	GHKUDWSJS52S*
	6	2	2460	8	1-7/16	17-1/2	GHKUDWSJS62S*
	8	2	3000	10-1/8	2-1/16	18-1/2	GHKUDWSJS82S*
URETHANE / THICK TREAD / CAST IRON CORE (SCS/SAS) WHEELS WITH PRECISION BALL BEARINGS							
	5	2	1500	7-1/2	1-7/16	16-1/2	GHKUDWSCS/SAS52S*
	6	2	2000	8	1-7/16	17-1/2	GHKUDWSCS/SAS62S*
	8	2	2900	10-1/8	2-1/16	18-1/2	GHKUDWSCS/SAS82S*

*Precision Ball Bearing Wheels are Standard, "P" for Precision Bearing, "PL" for Plain Bearing, "R" for Roller Bearing or "T" for Tapered Bearing
Dimensions shown are nominal. If precise dimensions are required, consult Acorn™. Additional wheels available.

**MEGALOAD™ AND VULKOLLAN™ WHEELS WITH PRECISION BALL BEARINGS AVAILABLE TO FIT THIS CASTER SERIES.
SIZES 5 X 2, 6 X 2, & 8 X 2.**