

## Nitto Kohki SANDERS

## Acorn Industrial Products Co

520 Hertzog Boulevard | King of Prussia, PA 19406

Phone 800-523-5474 | Fax 800-782-6780

E-Mail acorn@acornindprod.com | Web acornindprod.com

### Palm Sander Features

- Compact and lightweight 1.6 lb. design
- Ergonomically designed for operator convenience and comfort
- Powerful high speed 10,000 rpm motor
- Ultra small orbital action for high quality swirl-free finishes
- Available with 5" or 6" pads
- Variable speed control



Model	<b>Palm Sander APS-125</b>
Air Pressure	85 psi
Air Consumption	15.9 CFM
Motor Free Speed	10,000 RPM
Orbit Diameter	3/16"
Paper Size	4-1/2" x 5-1/2"
Weight	1.6 lbs.
Pad	PSA
Spindle Thread	5/16-24
Horsepower	.37 hp
Accessories Included	spanner threaded adapter PT1/4" x NPT1/4"

Model	<b>Palm Sander APS-150</b>
Air Pressure	85 psi
Air Consumption	15.9 CFM
Motor Free Speed	10,000 RPM
Orbit Diameter	3/16"
Paper Size	6" dia.
Weight	1.59 lbs.
Pad	PSA
Spindle Thread	5/16-24
Horsepower	.37 hp
Accessories Included	spanner threaded adapter PT1/4" x NPT1/4"

### Orbital Sander Features

- Powerful 3/4 horsepower dual action for tough applications
- Available with 5" or 6" diameter pads
- Standard with dust extraction system
- Rugged construction for years of reliable performance



Model	<b>Orbital Sander OSV-50A</b>
Air Pressure	85 psi
Air Consumption	24.1 CFM
Motor Free Speed	8,500 RPM
Orbit Diameter	3/8" dia.
Disc Size	5" dia.
Weight	4.2 lbs.
Pad	PSA
Horsepower	.75 hp
Accessories Included	17mm spanner wrench, dust extraction system w/dust bag, threaded adapter PT1/4" x NPT1/4"

Model	<b>Orbital Sander OSV-60A</b>
Air Pressure	85 psi
Air Consumption	24.1 CFM
Motor Free Speed	8,500 RPM
Orbit Diameter	3/8" dia.
Disc Size	6" dia.
Weight	4.4 lbs.
Pad	PSA
Horsepower	.75 hp
Accessories Included	17mm spanner wrench, dust extraction system w/dust bag, threaded adapter PT1/4" x NPT1/4"

## Nitto Kohki SANDERS

## Acorn Industrial Products Co

520 Hertzog Boulevard | King of Prussia, PA 19406

Phone 800-523-5474 | Fax 800-782-6780

E-Mail acorn@acornindprod.com | Web acornindprod.com

### Free Sander Features

- Ideal for sanding and surface finishing wood, metal, plastic and other materials
- Lightweight design with minimal vibration
- High output and low air consumption motors produce high speed orbits for swirl-free finishes
- Oil free design
- Suitable for industrial and production applications



Model	<b>Free Sander FS-100C</b>
Air Pressure	85 psi
Air Consumption	7.1 CFM
Motor Free Speed	20,000 RPM
Orbit Diameter	1/16" dia.
Pad Size	4" x 4-3/8"
Paper Size	4-1/2" x 5-1/2"
Weight	1.1 lbs.
Accessories Included	hose E ass'y, sanding paper threaded adapter PT1/4" x NPT1/4"



Model	<b>Free Sander FS-50A</b>
Air Pressure	85 psi
Air Consumption	4.9 CFM
Motor Free Speed	15,000 RPM
Orbit Diameter	3/64" dia.
Pad Size	3" x 3-3/16"
Paper Size	2-3/4" x 4-1/2"
Weight	1.1 lbs.
Accessories Included	hose E ass'y, sanding paper threaded adapter PT1/4" x NPT1/4"

### Line Sander Features

- Ideal for most inline and profile sanding applications
- Compact and lightweight 1.6 lb. design
- Low vibration and minimal noise output
- Suitable for sanding steel, aluminum, wood, plastic, and other materials
- Available with dust collection assembly



Model	<b>Line Sander LS-10</b>
Air Pressure	85 psi
Air Consumption	3.9 CFM
Strokes per minute	4,000 SPM
Stroke	532"
Pad Size	2-5/32" x 4-1/16"
Paper Size	4-1/2" x 5-1/2"
Abrasive Paper Size	2-1/4" x 5-1/2"
Weight	1.6 lbs.
Accessories Included	sanding paper, block rubber pad, hose nipple threaded adapter PT1/4" x NPT1/4"

# FREE SANDER FS-100C ASSEMBLY AND PARTS LIST

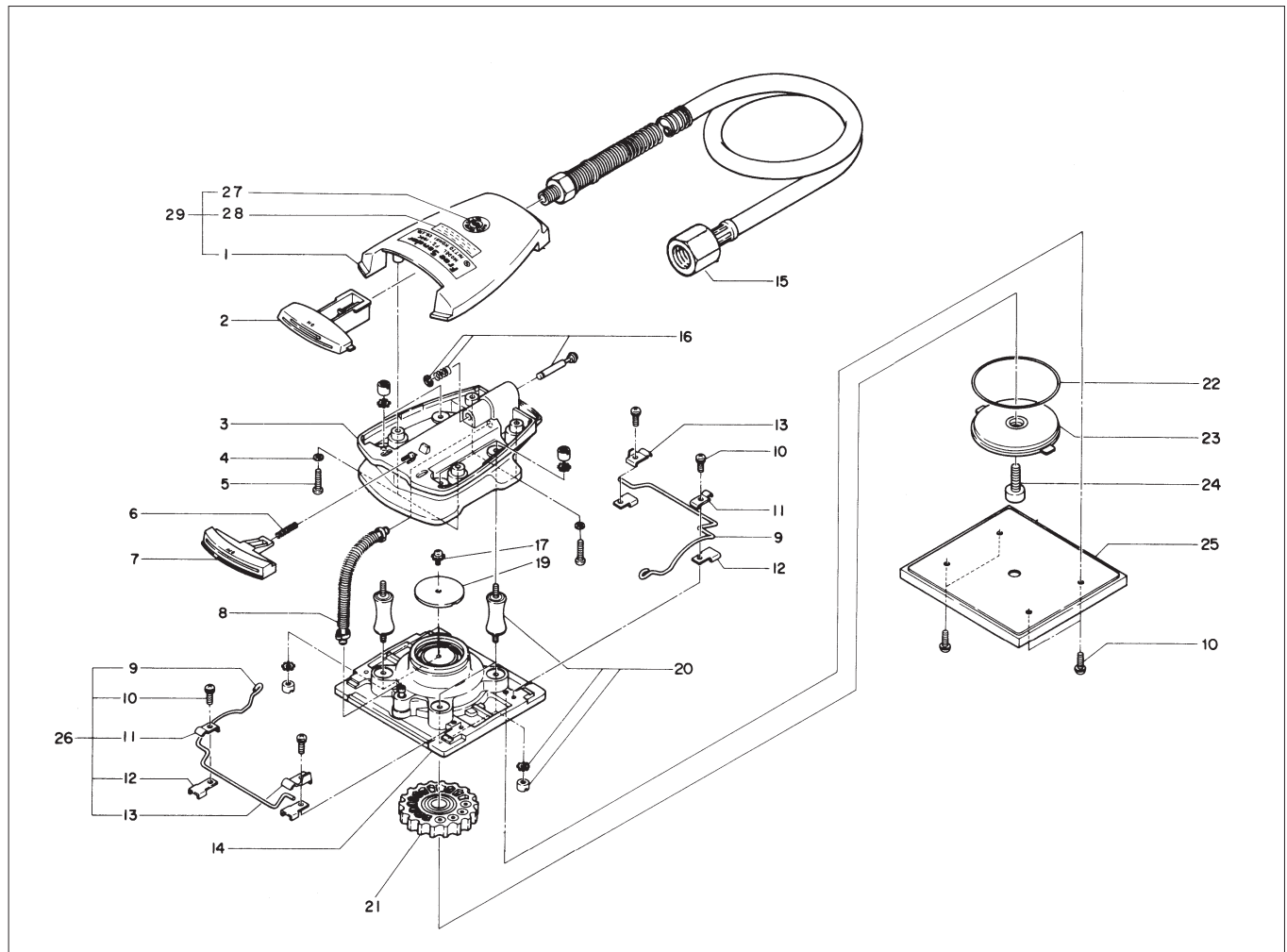

The Part Numbers with ( ) are included in the Ass'y parts written above them.

No.	Part No.	Part Name	Q'ty	Price
29	TB02335	Housing Cover Ass'y	1 set	
1	(TP15371)	Housing Cover	1	
27	(TP04218)	Nitto Label	1	
28	(TQ02207)	Label CE-Mark	1	
2	TP15374	Trigger	1	
3	TA99365	Housing Sub Ass'y	1 set	
4	TP04234	Washer M4	4	
5	TP14488	Screw M4 X 20	4	
6	TP15376	Spring 0.45 X 3.1 X 17	1	
7	TP15375	Cancel Switch	1	
8	TA91647	Tube Ass'y	1 set	
26*	TA99971	Clamp Ass'y	2	
9	TP10870	Clamp Spring	2	
10	TP11245	+ Screw 4 X 10	8	
11	TP10872	Clamp Stopper B	2	

\*Item numbers 9, 10, 11, 12 & 13 make up number 26

No.	Part No.	Part Name	Q'ty	Price
12	TP17901	Clamp Stopper C	4	
13	TP10871	Clamp Stopper A	2	
14	TA9A372	Base Plate Sub Ass'y	1 set	
15	TA92035	Hose Sub Ass'y	1 set	
16	TA99364	Throttle Valve Ass'y	1 set	
17	TA91575	+ Screw 4 X 8	1 set	
19	TP16951	Filter	1	
20	TA96330	Rubber Support Ass'y	4 sets	
21	TA9A369	Turbine Ass'y	1 set	
22	TP03790	O-Ring S-56	1	
23	TA9A371	End Cap Ass'y	1 set	
24	TP01945	Hex. Bolt 5 X 12	1	
25	TA9A367	Rubber Pad Ass'y	1 set	

## ACCESSORIES

	TA91474	Convex Pad	1	
--	---------	------------	---	--

# FREE SANDER FS-50A ASSEMBLY AND PARTS LIST

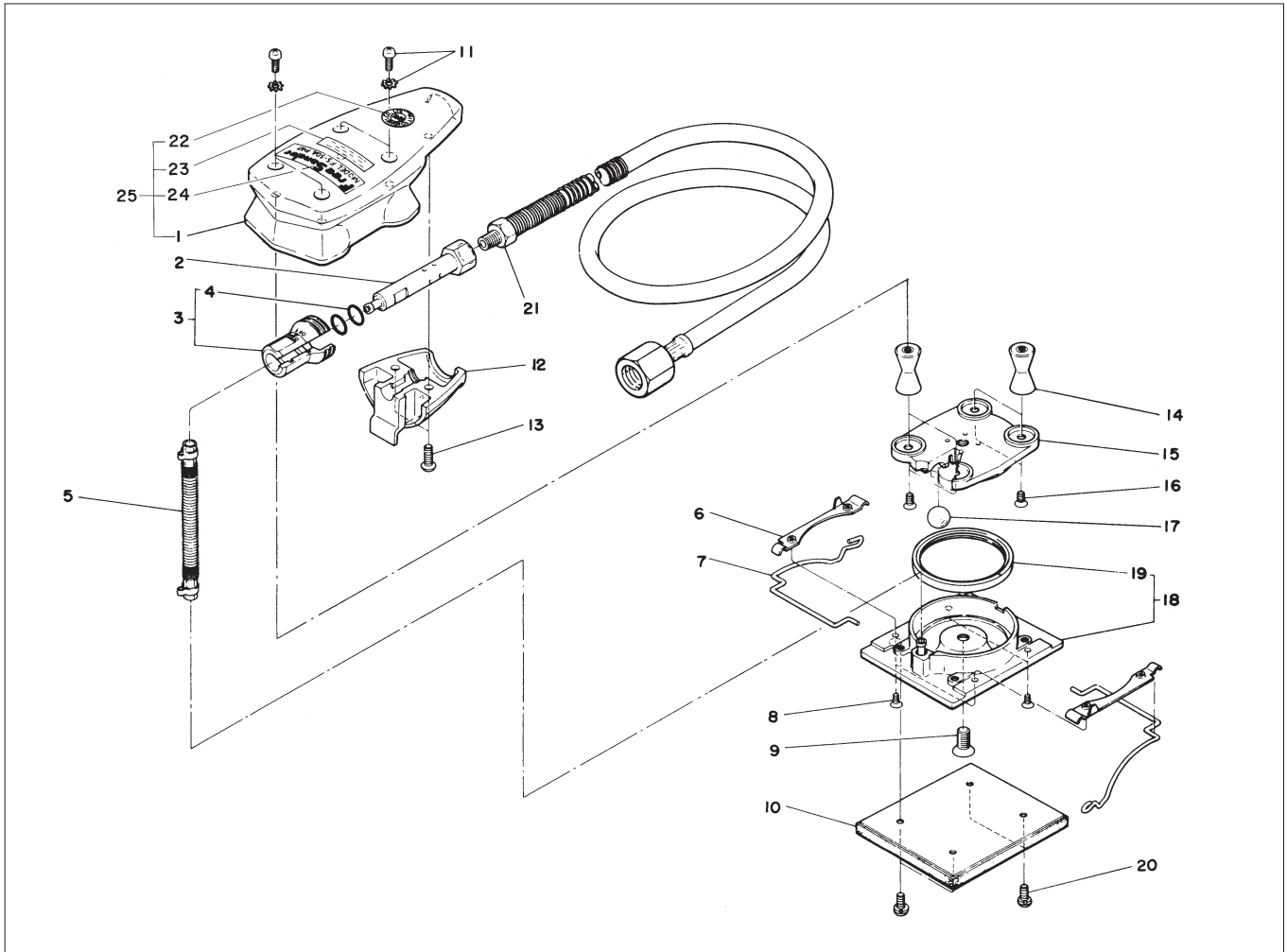

The Part Numbers with ( ) are included in the Ass'y parts written above them.

No.	Part No.	Part Name	Q'ty	Price
25	TB05700	Housing Sub Ass'y	1 set	
1	(TP05700)	Housing	1	
22	(TP04218)	Nitto Label	1	
23	(TQ02207)	Label CE-Mark	1	
24	(TP05745)	Name Plate	1	
2	TP05698	Valve Nipple	1	
3	TP05699	Trigger	1	
4	(TP12004)	O-Ring P-10	2	
5	TA91647	Tube Ass'y	1 set	
6	TP05708	Clamp Stopper	2	
7	TP05757	Clamp Spring	2	
8	TP05709	Hex. Screw 3 X 6	4	
9	TP04226	+ Screw 6 X 14	1	

No.	Part No.	Part Name	Q'ty	Price
10	TA99828	Rubber Pad Ass'y	1 set	
11	TA91575	+ Screw 4 X 8	4 sets	
12	TP05701	Housing Cap	1	
13	TP04217	Screw 4 X 10	2	
14	TA91465	Rubber Support Ass'y	4 sets	
15	TP05705	End Plate	1	
16	TP05712	+ Screw 4 X 6	4	
17	TP05706	Ball 15/32	1	
18	TA92337	Cylinder Sub Ass'y	1 set	
19	(TP05703)	Cylinder	1	
20	TP06290	+ Screw 4 X 8	4	
21	TA92035	Hose Sub Ass'y	1 set	

# LINE SANDER LS-10 ASSEMBLY AND PARTS LIST

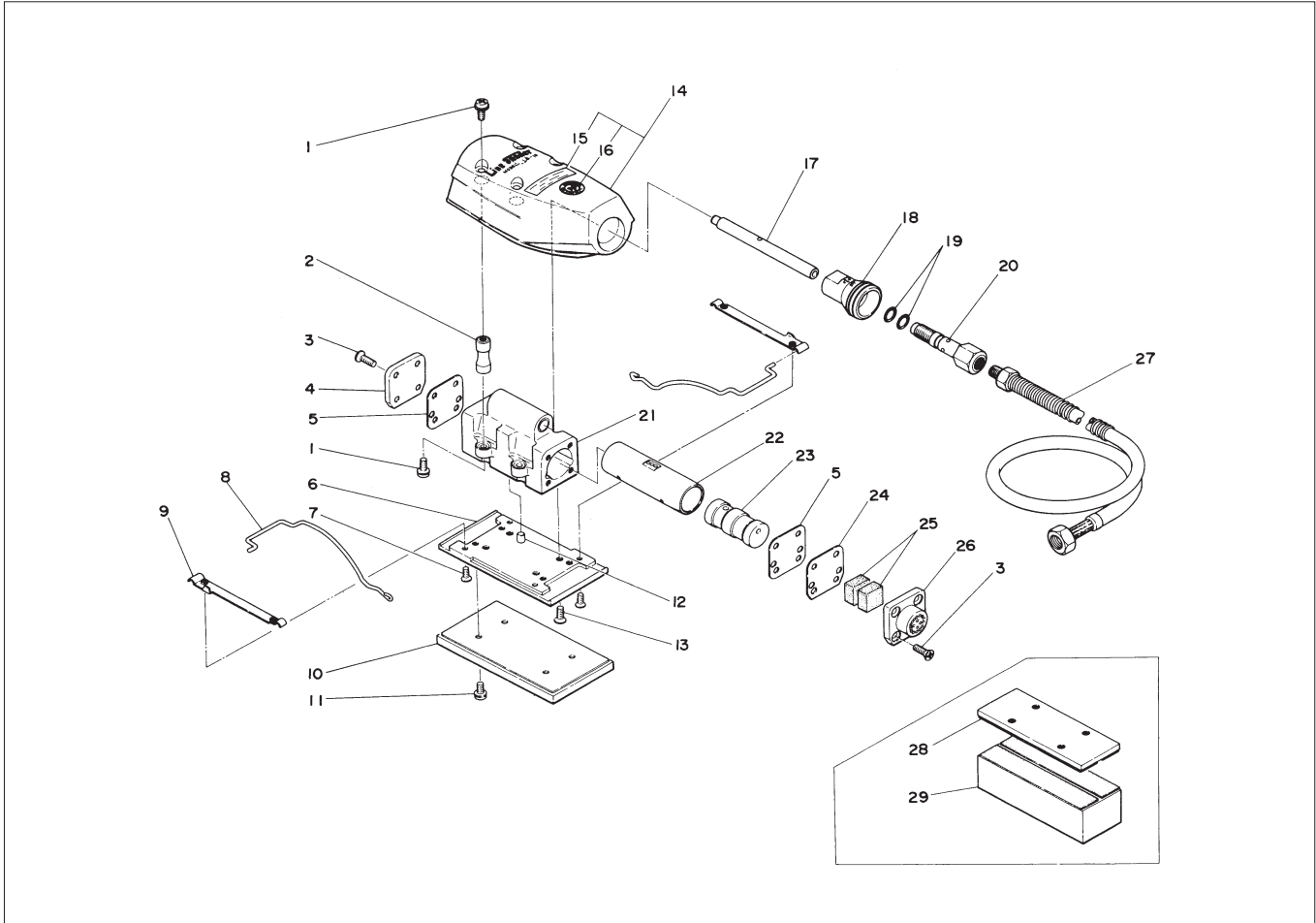

The Part Numbers with ( ) are included in the Ass'y parts written above them.

No.	Part No.	Part Name	Q'ty	Price
1	TP11245	+ Screw 4 X 10	8	
2	TA96664	Rubber Support Ass'y	4 sets	
3	TP04217	Screw 4 X 10	8	
4	TP11249	Cap A	1	
5	TP11251	Packing	2	
6	TP11259	Base Plate	1	
7	TP05709	Hex. Screw 3 X 6	4	
8	TP11260	Clamp Spring	2	
9	TP11261	Clamp Stopper	2	
10	TA96665	Rubber Pad Ass'y	1 set	
11	TP06290	+ Screw 4 X 8	12	
12	TP12208	Parallel Pin 4 X 6.5	1	
13	TP00123	+ Screw 4 X 8	4	
14	TP11243	Housing	1 set	
15	(TQ02207)	Label CE-Mark	1	

No.	Part No.	Part Name	Q'ty	Price
16	(TP04218)	Label NITTO	1	
17	TP11244	Guide Shaft	1	
18	TP05699	Trigger	1	
19	TP12004	O-Ring P-10	2	
20	TP11258	Valve Nipple	1	
21	TA96660	Cylinder Case Sub Ass'y	1 set	
22	TP11247	Cylinder	1	
23	TP11248	Piston	1	
24	TP11254	Plate	1	
25	TP11253	Fiiter	2	
26	TP11250	Cap B	1 set	
27	TA92035	Hose Sub Ass'y	1	
28	TA96738	Base Plate A Ass'y	1 set	
29	TA96739	Block Pad Sub Ass'y	1 set	

# PALM ORBITAL SANDER APS-125/150 SERIES ASSEMBLY AND PARTS LIST

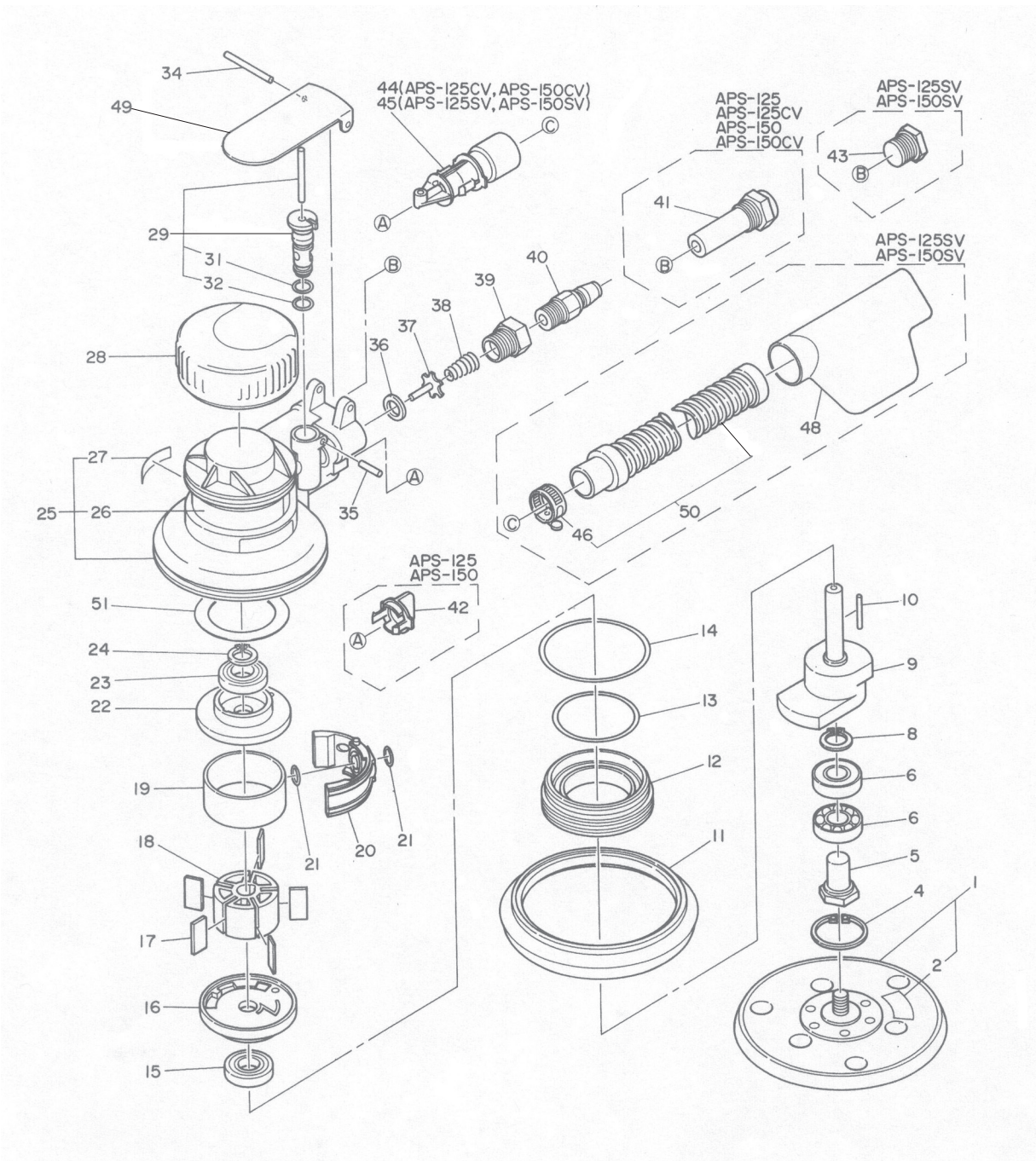

The Part Numbers with ( ) are included in the Ass'y parts written above them.

**APS-125**

No.	Part No.	Part Name	Q'ty	Price
1	TB03801	Pad 5" PSA 5-Hole	1 set	
2	(TQ05090)	APS Caution Label	1	
4	TQ04650	Retaining Ring IRTW-28	1	
5	TQ04648	Spindle	1	
6	TP05650	Ball Bearing 6001DUCM	2	
8	TP03546	Retaining Ring C-12	1	
9	TQ04647	Counter Shaft 5"	1	
10	CP23473	Needle Holder	1	
11	TQ04669	Cover	1	
12	TQ05817	Lock Ring	1	
13	CQ05893	O-Ring S-44	1	
14	TP03790	O-Ring S-56	1	
15	TQ04657	Ball Bearing 6000 LLU	1	
16	TQ04652	End Plate B	1	
17	TB04867	Blades (5 pcs/set)	1 set	
18	TQ06477	Rotor	1	
19	TQ04684	Cylinder	1	
20	TQ04655	Backbone	1	
21	TP12004	O-Ring P-10	2	
22	TQ04651	End Plate A	1	
23	TP01913	Ball Bearing 6000 Z	1	
24	TQ04656	Bent Retaining Ring BG-10	1	
51	TQ04764	Spacer 52 X 38 X 0.5	1	
25	TB04429	Housing Ass'y	1 set	
26	(TQ04710)	APS Nitto Label	1	
27	(TQ04646)	APS-125 Model Number Label	1	
28	TQ04771	Rubber Grip	1	
29	TB03695	Adjust Valve Ass'y	1 set	
31	(CP20531)	O-Ring P-9	1	
32	(CP20521)	O-Ring P-8	1	
49	TB03696	Throttle Lever Ass'y	1 set	
34	TQ04661	Spring Pin 3 X 36 AW	1	
35	TP15729	Spring Pin 3 X 14	1	
36	TQ04671	Seal Sheet 9 X 13.9 X 2	1	
37	TQ04664	Valve	1	
38	TQ04665	Conical Spring 0.8 X 6.4 X 11.6	1	
39	TQ04666	Bushing M16 X PT1/4	1	
41	TB03593	Muffler Ass'y	1 set	
53	TQ05088	O-Ring SS-100	1	
42	TQ04667	Cap	1	
	TQ06276	Oil Daily Label		

**APS-125SV**

No.	Part No.	Part Name	Q'ty	Price
25	TB04429	Housing Ass'y	1 set	
26	(TQ04710)	APS Nitto Label	1	
27	(TQ04693)	Model Number APS-125SV Label	1	
43	TQ04685	Hex. Head Bolt M16 X 11 P1.5	1	
45	TB03594	Ejector Ass'y	1 set	
50	TA99239	Hose Ass'y	1 set	
46	(TP05662)	Hose Band	1	
48	TP14836	Dust Collection Bag	1	
52	LQ02848	P-Tite Screw	1	

**APS-125CV**

No.	Part No.	Part Name	Q'ty	Price
25	TB04431	Housing Ass'y	1 set	
26	(TQ04710)	Label Nitto APS	1	
27	(TQ04689)	Label Model Number APS-125CV	1	
41	TB03593	Muffler Ass'y	1 set	
44	TQ04682	Ejector	1	
52	LQ02848	P-Tite Screw	1	
53	TQ05088	O-Ring SS-100	1	

**ACCESSORIES**

	TP00474	Spanner 17	1	
	TP02236	Bushing PT 1/4 X NPT 1/4	1	
	TQ04674	Instruction Manual	1	
	TB03669	Pad 5" Velcro 5 Hole	1 set	

The Part Numbers with ( ) are included in the Ass'y parts written above them.

**APS-150**

No.	Part No.	Part Name	Q'ty	Price
1	TB03885	Pad 6" PSA 6 Hole	1 set	
2	(TQ05090)	APS Caution Label	1	
4	TQ04650	Retaining Ring IRTW-28	1	
5	TQ04648	Spindle	1	
6	TP05650	Ball Bearing 6001DUCM	2	
8	TP03546	External Retaining Ring C-12	1	
9	TQ04679	Counter Shaft	1	
10	CP23473	Needle Holder	1	
11	TQ04669	Cover	1	
12	TQ05817	Lock Ring	1	
13	CQ05893	O-Ring S-44	1	
14	TP03790	O-Ring S-56	1	
15	TQ04657	Ball Bearing 6000 LLU	1	
16	TQ04652	End Plate B	1	
17	TB04867	Blades (5 pcs/set)	1 set	
18	TQ06477	Rotor	1	
19	TQ04684	Cylinder	1	
20	TQ04655	Backbone	1	
21	TP12004	O-Ring P-10	2	
22	TQ04651	End Plate A	1	
23	TP01913	Ball Bearing 6000 Z	1	
24	TQ04656	Bent Retaining Ring BG-10	1	
51	TQ04764	Spacer 52 X 38 X 0.5	1	
25	TB04435	Housing Ass'y	1 set	
26	(TQ04710)	APS Nitto Label	1	
27	(TQ04678)	Model Number APS-150 Label	1	
28	TQ04771	Rubber Grip	1	
29	TB03695	Adjust Valve Ass'y	1 set	
31	(CP20531)	O-Ring P-9	1	
32	(TP20521)	O-Ring P-8	1	
49	TB03696	Throttle Lever Ass'y	1 set	
34	(TQ04661)	Spring Pin 3 X 36 AW	1	
35	TP15729	Spring Pin 3 X 14	1	
36	TQ04671	Seal Sheet 9 X 13.9 X 2	1	
37	TQ04664	Valve	1	
38	TQ04665	Conical Spring 0.8 X 6.4 X 11.6	1	
39	TQ04666	Bushing M16 X PT 1/4	1	
41	TB03593	Muffler Ass'y	1 set	
53	TQ05088	O-Ring SS-100	1	
42	TQ04667	Cap	1	

**APS-150SV**

No.	Part No.	Part Name	Q'ty	Price
25	TB04439	Housing Ass'y	1 set	
26	(TQ04710)	APS Nitto Label	1	
27	(TQ04695)	Model Number APS-150SV Label	1	
43	TQ04685	Hex. Head Bolt M16 X 11 P.1.5	1	
45	TB03594	Ejector Ass'y	1 set	
50	TA99239	Hose Ass'y	1 set	
46	(TP05662)	Hose Band	1	
48	TP14836	Dust Collection Bag	1	
52	LQ02848	P-Tite Screw	1	

**APS-150CV**

No.	Part No.	Part Name	Q'ty	Price
25	TB04431	Housing Ass'y	1 set	
26	(TQ04710)	APS Nitto Label	1	
27	(TQ04691)	Model Number APS-150CV Label	1	
41	TB03593	Muffler Ass'y	1 set	
44	TQ04682	Ejector	1	
52	LQ02848	P-Tite Screw	1	
53	TQ05088	O-Ring SS-100	1	

**ACCESSORIES**

No.	Part No.	Part Name	Q'ty	Price
	TP00474	Spanner 17	1	
	TP02236	Bushing PT1/4 X NPT1/4	1	
	TQ04674	Instruction Manual	1	
	TB03650	Pad 6" Velcro 6-Hole	1 set	



# ORBITAL SANDER OSV-60A ASSEMBLY AND PARTS LIST

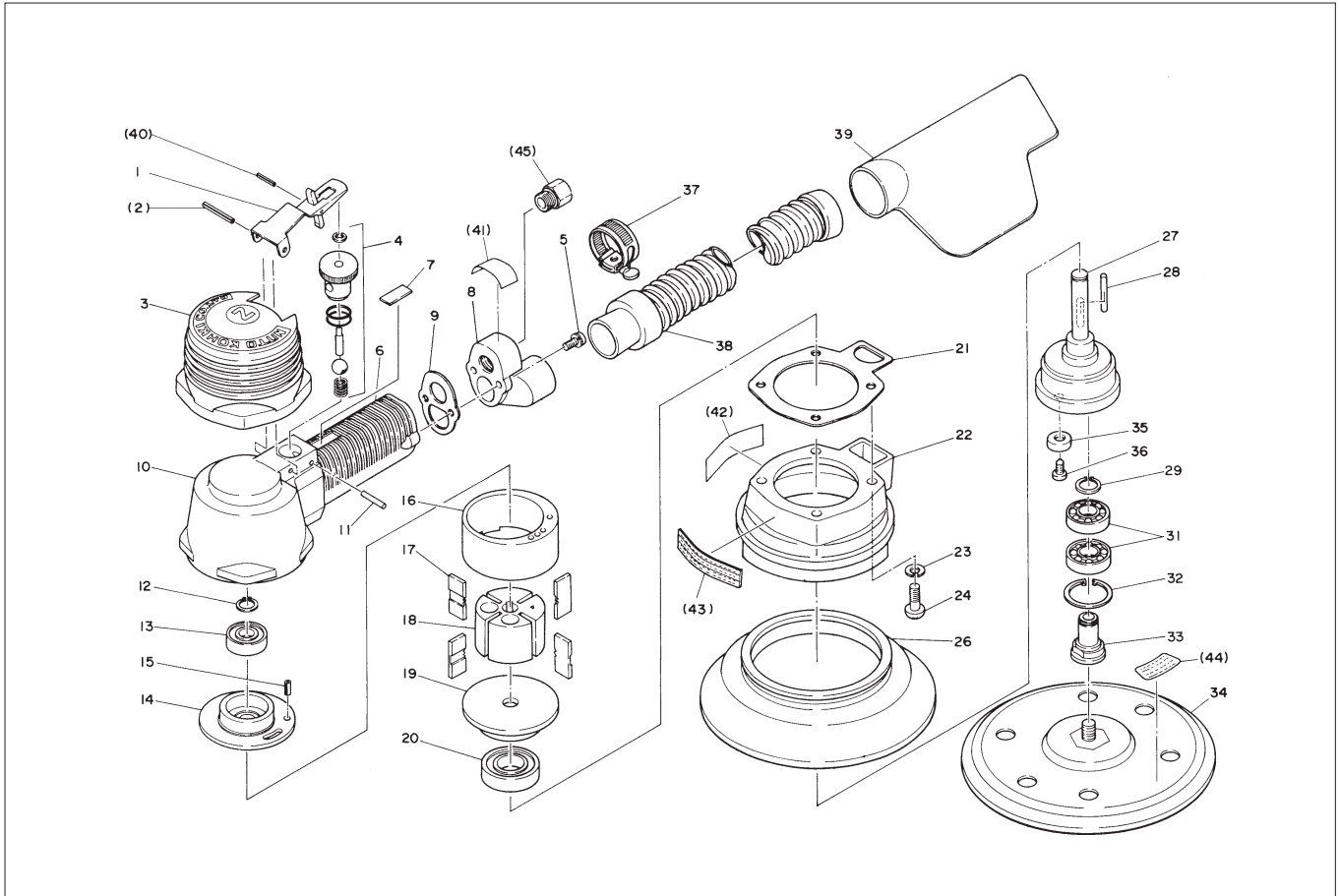

The Part Numbers with ( ) are included in the Ass'y parts written above them.

No.	Part No.	Part Name	Q'ty	Price
1	TB02151	Throttle Lever Ass'y	1 set	
2	(TP01802)	Spring Pin 3 X 28	1	
40	(TP05498)	Spring Pin 2 X 16	1	
3	TP14808	Housing Cover	1	
4	TA99063	Valve Ass'y	1 set	
5	LP30942	Screw 4 X 14	2	
6	TP14810	Grip Tube	1	
7	TQ02790	Lever Wear Plate	1	
8	TB02276	Rear Cap Ass'y	1 set	
41	(TQ02207)	Label CE-Mark	1	
9	TP14804	Gasket A	1	
10	TP14809	Housing	1	
11	TP20537	Spring Pin 3 X 21.8	1	
12	TP04595	Retaining Ring C-10	1	
13	TP01913	Ball Bearing 6000 Z	1	
14	TP14817	End Plate A	1	
15	TP08932	Spring Pin 4 X 8	1	
16	TP14820	Cylinder	1	
17	TA9A288	Blades (4 pcs/set)	1 set	
18	TP05980	Rotor	1	
19	TP14818	End Plate B	1	
20	TQ01504	Ball Bearing 6003LLB	1	
21	TP14811	Gasket B	1	
22	TB02218	Base Cover Ass'y	1 set	
42	(TQ02915)	Warning Label - OSV-60A	1	

No.	Part No.	Part Name	Q'ty	Price
43	(TQ02923)	Plate Model Number OSV-60A	1	
23	TP00513	Spring Washer M5	4	
24	LP30138	+ Screw 5 X 14	4	
26	TP14875	Cover 6"	1	
27	TP14869	Counter Shaft	1	
28	TP14822	Sunk Key 2.5 X 3.8 X 20	1	
29	TP03546	Retaining Ring C-12	1	
31	TP05650	Ball Bearing 6001DUCM	2	
32	TP01036	Retaining Ring C-28	1	
33	TP05984	Spindle	1	
34	TB03898	Pad 6" B-H Ass'y	1 set	
44	(TP16713)	Caution Label	1	
35	TP14876	Weight	1	
36	TP05986	- Screw 5 X 8	1	
37	TP05662	Hose Band	1	
38	TA99239	Hose Ass'y	1	
39	TP14836	Dust Collection Bag	1	
45	TQ00857	Bushing M16 X PT1/4	1	

## ACCESSORIES

	TB03890	Pad 5" V-H Ass'y - Velcro	1	
	U40022	Pad 5" w/holes - PSA	1	
	U40021	Pad 5" w/o holes - PSA	1	
	TP14868	5" Cover	1	

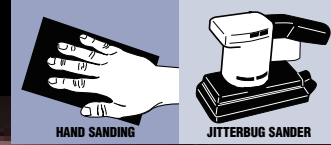

## Cloth Sheets

Engineered for maximum flexing and fast cutting, cloth sheets have a longer life than paper sheets. They tear cleanly and straight without shedding and are packed in a protective dispenser to eliminate waste and damage.

### Typical Applications

- Scouring and light deburring
- Scale and rust removal
- Blending machine tool marks
- Fine sanding and polishing

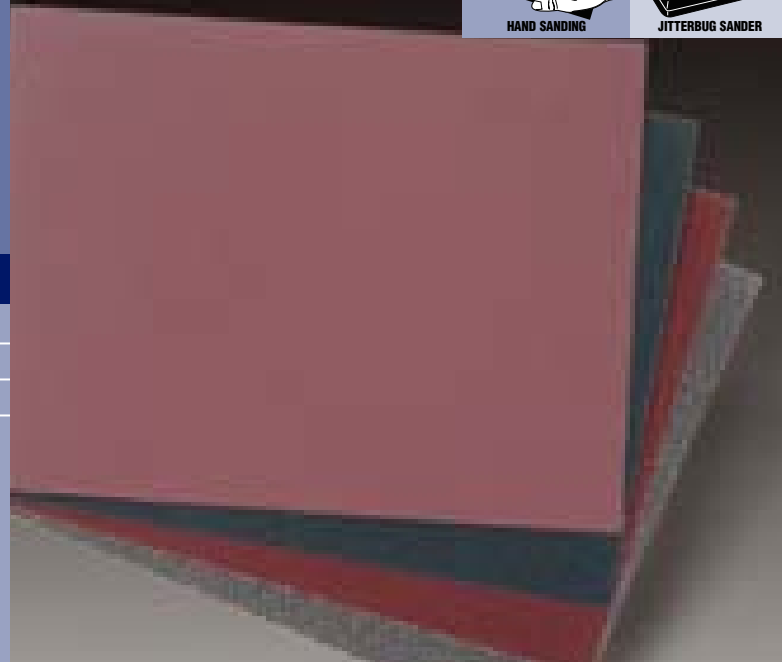

#### **GOOD** Metalite K225 Sheets – General purpose metalworking applications

FEATURES	BENEFITS
• Premium P-graded aluminum oxide abrasive	• Greater cut rate than competitive products
• Advanced full resin bond system	• Exceptional grain adhesion for longer life
• Flexible J-wt cotton backing	• Superior conformability to complex surfaces and better finishes



#### **GOOD** Lightning Metalite K227 Sheets – For quality finishing and polishing

FEATURES	BENEFITS
• P-graded aluminum oxide abrasive	• Fast cut rate and consistent finish
• Resin bond system	• Long life
• J-wt cotton backing with increased flexibility	• Superior conformability to complex surfaces and better finishes



#### **GOOD** Emery K622 Sheets – Ideal for extra fine finishes

FEATURES	BENEFITS
• K622 – Highest quality, natural emery abrasive	• Produces extra fine finishes, ideal for lapping



#### **GOOD** Screen-Bak Durite Q421 Sheets – For wet or dry applications

FEATURES	BENEFITS
• P-graded silicon carbide abrasive (220 and coarser) on an open mesh backing	• Extreme resistance to loading, long life
	• Waterproof

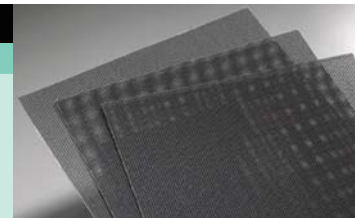

# CLOTH SHEETS

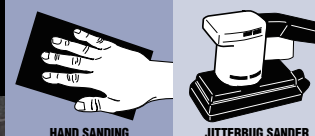

HAND SANDING

JITTERBUG SANDER

## 9 x 11 Cloth Sheets

SIZE	GRIT	MIN./STD. PKG.	GOOD METALITE K225*	GOOD METALITE K227*	GOOD EMERY K622	GOOD** SCREEN-BAK Q421†
			UPC NO.	UPC NO.	UPC NO.	UPC NO.
9 x 11	40	25/125	66261058713* <b>new!</b>			
	50	25/125	66261101862*			
	60	25/125	66261101861*			
	80	25/125	66261126340	66261101750		66261100960*
	100	50/250	66261126339	66261101745		66261100955*
	120	50/250	66261126338	66261101740		66261100950*
	150	50/250	66261126337	66261101735		66261100945*
	180	50/250	66261126336	66261101730		66261100940*
	220	50/250	66261126335			66261100935*
	240	50/250	66261126334			
	280	50/250	66261126333	66261101720		
	320	50/250	66261126332	66261101710		66261100920*
	400	50/250	66261126331	66261101705		66261100915*
	500	50/250		66261101700		
	600	50/250	66261126330			
	Extra Coarse	25/125			66261101255	
	Coarse	25/125			66261101250	
	Medium	50/250			66261101245	
	Fine	50/250			66261101240	
	Finer than 500	50/250				

\*SUPPLIED IN E-Z FLEX METALITE K224

\* P-GRADED

† WATERPROOF

• PACKAGING STANDARDS: MIN./STD. PKG. Q421 = 25/125



### Cloth Sheet Starting Recommendations

WATERPROOF LOAD RESISTANT	FAST CUT GENERAL FINISH	SLOW CUT FINE FINISH
Screen-Bak Durite Q421	Metalite K225	Emery K622

### Cloth Sheet Competitive Cross Reference

NORTON	3M	HERMES	KLINGSPOR	SIA	VSM
K224	311T Three-M-Ite BG 211K Electrocut	RB317LX	CS310X		KK504X
K225/K227	211K Three-M-Ite 311K Three-M-Ite	RB232J	KL361	2947J	KK504J KK504X
K622	011K Crystal Bay		KL371	C680J	
Q421	481W				

## TECHtip

Use light machine oil with cloth sheets as a lubricant for finer finishes and quicker cut.



It is the user's responsibility to refer to and comply with ANSI B7.7

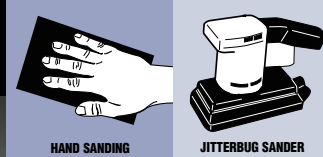

## Paper Sheets

Full size (9" x 11") and cut sheets are used for both metalworking and woodworking applications. Packed in protective dispensers and/or convenient job packs to eliminate waste and permit easy, neat storage.

### Typical Applications

- Light duty, metal sanding
- Primer sanding, defect removal from painted surfaces
- Filler sanding
- Sanding and finishing of composites and fiberglass
- Bare wood sanding
- Sanding between sealer coats



## Light Weight Paper Sheets

### **BEST** No-Fil Adalox A275 Sheets – The performance leader for dry finishing

FEATURES	BENEFITS
• Premium P-graded, heat-treated aluminum oxide abrasive	• Superior life, fast cut rate, consistent finish
• Unique fiber-reinforced, B-wt latex-saturated backing	• 50-60% improvement in tear strength
• Water-based stearate, non-pigmented, No-Fil coating	• Flexible; can be used wet
• Ultra fine grit (P1000, P1200, P1500) upgrade	• Provides maximum load resistance and extended life; no color transfer to work
	• Excellent cut rate and total cut, while minimizing loading = maximum life



### **BEST** Norton 3X NO-Fil Paper Sheet Job Packs – Fast Cut Rate

FEATURES	BENEFITS
• Open coat, premium aluminum oxide abrasive grain	• Hard, tough; provides a free cutting action for quick initial cut and maximum life
• Non-pigmented stearate coating	• Provides maximum resistance to clogging for longer life especially when sanding soft materials
• High-strength, fiber-reinforced, latex-saturated paper backing	• Tear resistant; provides exceptional flexibility when folding to get into corners and crevices
• Full resin adhesive bond	• Provides exceptional resistance to abrasive grain shedding especially when folding to sand into corners; long life



### **GOOD** No-Fil Adalox A251 Sheets – Unrivaled flexibility and finish – dry

FEATURES	BENEFITS
• P-grade aluminum oxide abrasive	• Increased life, consistent finish
• A-wt paper backing	• Increased flexibility for hand sanding applications
• Stearated (No-Fil), open coat	• Reduced loading



### **GOOD** No-Fil Adalox A290 Sheets – Unrivaled durability and value for dry finishing

FEATURES	BENEFITS
• P-graded aluminum oxide abrasive	• Increased life, fast cut rate, consistent finish
• Heavy-duty, C-wt backing	• Edge-tear resistance, durable for cut sheet machine sanding applications
• Stearated (No-Fil), open coat	• Reduced loading



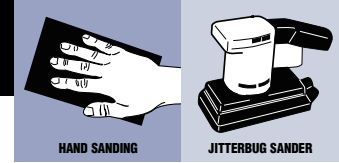

## Light Weight Paper Sheets (CONTINUED)

<b>GOOD</b>	<b>Adalox A212, A213, A211 Sheets – For dry, general purpose sanding</b>
<b>FEATURES</b>	<b>BENEFITS</b>
<ul style="list-style-type: none"> <li>Aluminum oxide grain, open-coat Available in three backing weights: A212 A-wt, A213 C-wt, A211 D-wt</li> <li>Extensive, P-graded grit range (P36 – P220 grit)</li> </ul>	<ul style="list-style-type: none"> <li>Aggressive cutting action for all dry sanding applications</li> <li>Designed for heavy-duty to light-duty hand and machine sanding, coarse to fine</li> </ul>



<b>GOOD</b>	<b>MultiSand Paper Sheet Job Packs – Versatile</b>
<b>FEATURES</b>	<b>BENEFITS</b>
<ul style="list-style-type: none"> <li>Aluminum oxide open coat</li> <li>Extensive, P-graded grit range (P36 – P220 grit)</li> </ul>	<ul style="list-style-type: none"> <li>Versatile; for hand or machine sanding wood, metal, plastic and fiberglass and for removing old paint</li> </ul>



<b>GOOD</b>	<b>No-Fil Durite A413/A414 Sheets – Good general purpose choice</b>
<b>FEATURES</b>	<b>BENEFITS</b>
<ul style="list-style-type: none"> <li>Sharp silicon carbide abrasive</li> <li>A413 – B-wt paper backing</li> <li>A414 – A-wt paper backing</li> <li>Stearated (No-Fil), open coat</li> </ul>	<ul style="list-style-type: none"> <li>Excellent for finishing</li> <li>Penetrates dense, hard materials (glass, ceramics, etc.)</li> <li>Flexible, yet durable</li> <li>Very flexible and conformable, soft-acting</li> <li>Reduced loading</li> </ul>



<b>GOOD</b>	<b>Garnet A511, A513, A514 Sheets – Ideal on soft woods</b>
<b>FEATURES</b>	<b>BENEFITS</b>
<ul style="list-style-type: none"> <li>Natural garnet grain</li> <li>Available in three backing weights: A511 A-wt, A513 C-wt, A514 D-wt</li> </ul>	<ul style="list-style-type: none"> <li>Excellent for soft woods, consistent finishes</li> <li>Designed for heavy-duty to light-duty hand and machine sanding, coarse to fine</li> </ul>



<b>GOOD</b>	<b>WoodSand Paper Sheet Job Packs – For prepping wood</b>
<b>FEATURES</b>	<b>BENEFITS</b>
<ul style="list-style-type: none"> <li>Natural garnet grain</li> </ul>	<ul style="list-style-type: none"> <li>The choice when preparing bare wood surfaces for stains or finishes</li> </ul>



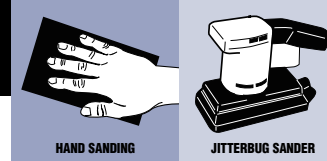

## Waterproof Paper Sheets

### BEST Black Ice T214 Waterproof Sheets – Ultimate performance for wet applications

FEATURES	BENEFITS
<ul style="list-style-type: none"> <li>Premium, P-graded, heat-treated aluminum oxide abrasive</li> </ul>	<ul style="list-style-type: none"> <li>Ultimate cut and life in wet applications</li> </ul>
<ul style="list-style-type: none"> <li>Strong, resin bond system</li> </ul>	<ul style="list-style-type: none"> <li>Long life in wet applications</li> </ul>
<ul style="list-style-type: none"> <li>B-wt, high-latex, waterproof paper backing</li> </ul>	<ul style="list-style-type: none"> <li>Ultimate flexibility</li> <li>Wet-curl resistance</li> <li>Environmentally stable, resists humidity-caused curling</li> </ul>



### BEST Black Ice T402 Waterproof Sheets – Ultimate surface finishes – wet

FEATURES	BENEFITS
<ul style="list-style-type: none"> <li>Premium, ultra fine (1000 – 2500 grits) silicon carbide abrasive</li> </ul>	<ul style="list-style-type: none"> <li>Ultimate finish in wet applications</li> </ul>
<ul style="list-style-type: none"> <li>Strong resin bond system</li> </ul>	<ul style="list-style-type: none"> <li>Long life in wet applications</li> </ul>
<ul style="list-style-type: none"> <li>New, higher strength B-wt waterproof paper backing</li> </ul>	<ul style="list-style-type: none"> <li>Extremely flexibility</li> <li>Wet-curl resistance</li> <li>Environmentally stable; resists humidity-caused curling</li> </ul>



### BETTER Blue-Bak T414 Waterproof Sheets – Exceptional finishing in wet applications

FEATURES	BENEFITS
<ul style="list-style-type: none"> <li>Sharp silicon carbide abrasive (220-600 grit range)</li> </ul>	<ul style="list-style-type: none"> <li>Exceptional finishes in wet applications</li> </ul>
<ul style="list-style-type: none"> <li>Strong resin bond</li> </ul>	<ul style="list-style-type: none"> <li>Longer life in wet applications</li> </ul>
<ul style="list-style-type: none"> <li>New, higher strength B-wt waterproof paper backing</li> </ul>	<ul style="list-style-type: none"> <li>Extremely flexible</li> <li>Improved wet-curl resistance</li> <li>Environmentally stable; resists humidity-caused curling</li> </ul>



### GOOD Tufbak Waterproof T461 Sheets – For more aggressive applications

FEATURES	BENEFITS
<ul style="list-style-type: none"> <li>Silicon carbide abrasive</li> </ul>	<ul style="list-style-type: none"> <li>Fast cutting with excellent finish in wet applications</li> </ul>
<ul style="list-style-type: none"> <li>Strong, waterproof C-wt backing</li> </ul>	<ul style="list-style-type: none"> <li>Ideal for more aggressive applications</li> <li>Environmentally stable, resists product curl in humidity</li> <li>Resists chipping and cracking</li> </ul>
<ul style="list-style-type: none"> <li>Advanced resin bond system</li> </ul>	<ul style="list-style-type: none"> <li>Excellent flexibility and abrasive adhesion</li> </ul>



### GOOD SandWet Paper Sheet Job Packs – For topcoat sanding

FEATURES	BENEFITS
<ul style="list-style-type: none"> <li>Sharp silicon carbide abrasive</li> <li>Waterproof A-wt backing</li> </ul>	<ul style="list-style-type: none"> <li>Ideal for wet, oil or dry sanding primer, sealer, varnish, lacquer, enamel and other topcoats</li> </ul>



## Heavy Paper Sheets

### BETTER NorZon Plus H875 Sheets – Excellent for soft material applications

FEATURES	BENEFITS
<ul style="list-style-type: none"> <li>Patented NorZon Plus zirconia abrasive</li> </ul>	<ul style="list-style-type: none"> <li>Extended life over original NorZon products</li> </ul>
<ul style="list-style-type: none"> <li>Strong E-wt paper, latex impregnated</li> </ul>	<ul style="list-style-type: none"> <li>Increased durability and chip resistance, flexible</li> </ul>
<ul style="list-style-type: none"> <li>Open coat design</li> </ul>	<ul style="list-style-type: none"> <li>Reduced loading; ideal for body filler, fiberglass and composite sanding</li> </ul>

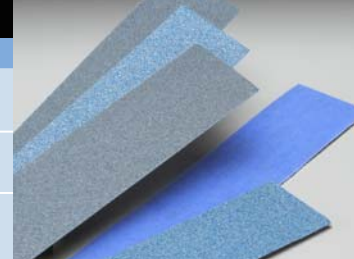

# PAPER SHEETS



## File Sheets

Used on manual or air file boards for sanding, shaping, and finishing.

SIZE	GRIT	MIN/STD. PKG.	BEST A275*				GOOD H290*	MIN/STD. PKG.	BETTER H875		MIN/STD. PKG.	BETTER H875
			NON-PSA	PSA	NORGRIP	NORGRIP VACUUM	PSA		NON-PSA	PSA		NORGRIP
2-3/4 x 16	100	50/500				66261131657						
	120					66261131656						
	180					66261131654						
2-3/4 x 16-1/2	36	50/500					66261130840	50/250		66261123610	25/125	66261123616
	40									66261123609		66261123615
	80				66261131640	66261131646				66261123608		66261123614
	100				66261131639	66261131645						
	120					66261131644						
	150				66261131637	66261131643						
	180				66261131636	66261131642						
220				66261131641								
2-3/4 x 17-1/2	36	50/500						50/250	66261123622			
	40								66261123621			
	80		66261131652						66261123620			
	100		66261131651						66261126512			
	120		66261131650									
	150		66261131649									
180	66261131648											
220	66261131647							66261126511				

\* P-GRADED  
PACKAGING STANDARDS: MIN./STD. PKG.

## Paper Cut Sheets

SIZE	GRIT	MIN/STD. PKG.	GOOD A211*	GOOD A213*	GOOD A290*	BETTER T414†	
			UPC NO.	UPC NO.	UPC NO.	UPC NO.	
3-2/3 x 9	60	100/1000	66261102925				
	80		66261102920				
	100			66261102900		66261101119	
	120			66261102895			
	150					66261101125	
	180					66261101124	
	220					66261101123	
	280						66261139359
	320						66261139357
	400						66261139356
600					66261139354		
					66261139352		

\* P-GRADED  
† WATERPROOF



## NorGrip Sanding Blocks

Used with NorGrip cut sheets, these blocks fit comfortably in your hand. Soft – Flexible, yet tough, foam designed for flat and contoured surfaces.

Firm – Sturdy, high-strength material produces a true flat surface.



SIZE	DESCRIPTION	STD. PKG.	UPC NO.
2-3/4 x 5	NorGrip – Soft	5	63642542092
2-3/4 x 5	NorGrip – Firm	5	63642542093
2-3/4 x 7-3/4	NorGrip – Firm	5	63642542095

## Rubber Hand Sanding Block

A resilient rubber block that conforms well to mild contours and flat surfaces. 3-2/3" x 9" sheets are securely held by slotted "jaws" at each end of the block to permit quick, easy sheet changes.



SIZE	STD. PKG.	UPC NO.
3-2/3 x 9	14	07660743140

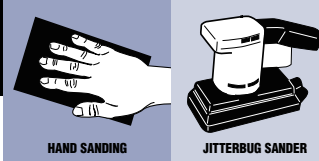

## 9 x 11 Paper Sheets

			LIGHT WEIGHT PAPER							
			BEST A275*	GOOD A251*	GOOD A211*	GOOD A213*	GOOD A212*	GOOD A413	GOOD A414	
SIZE	GRIT	MIN./STD. PKG.								
9 x 11	36	25/125								
	40									
9 x 11	50	50/250								
	60									
	80		66261131634	66261184107	66261100325 66261100320 66261100315			66261100801		
	100		66261131633	66261184106			66261100295	66261100800		
	120		66261131632	66261184105			66261100290 66261100285	66261100799		
9 x 11	150	100/500	66261131631	66261184108			66261100802			
	180		66261131630	66261184104			66261100245	66261100803		
	220		66261131629	66261184103			66261100240	66261100804		
	240		66261131628	66261184102			66261100805		66261134606	
	280		66261131627	66261184101						
	320		66261131626	66261184100			66261100807		66261134600	
	360									
	400		66261131624	66261184098						
	500		66261131623							
	600		66261131622							
9 x 11	800	100/500	66261131621							
	1000		66261131620							
	1200		66261131619							
	1500		66261131618							
9 x 11	2000	100/500								
	2500									

\* P-GRADED  
 † WATERPROOF  
 \* PACKAGING STANDARDS: T214, T402, T414, T461 = 50/250

## Emery Sheets

Durable C-wt. paper for fine metal polishing and metallurgical sample preparation.



GOOD A621

EMERY GRIT	CAMI GRIT	MIN./STD. PKG.	9 X 11 UPC NO.	9 X 13-3/4 UPC NO.
3	180	100/500		
2	220			
1	280		66261101263	66261101315*
0	500		66261101261	66261101310*
2/0	600		66261101260	66261101300*
3/0	1000		66261101259	66261101290*
4/0	1200		66261101258	66261101285*
				66261101280*
				66261101275*

\*PACKAGING STANDARDS: MIN. PKG./STD. PKG. = 100/1000





# PAPER SHEETS

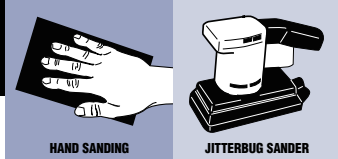

HAND SANDING

JITTERBUG SANDER

SIZE	GRIT	MIN./STD. PKG.	LIGHT WEIGHT PAPER			WATERPROOF PAPER			HEAVY
			GOOD A514	GOOD A513	GOOD A511	BEST T214†	BEST T402†	BETTER T414†	GOOD T461†
9 x 11	36								
	40								
	50	50/250	66261101565						
	60			66261101560					66261101175
	80			66261101555					66261101170
	100	100/500		66261101535	66261101500				66261101165*
	120			66261101530	66261101495				66261101160*
	150			66261101525	66261101490				66261101155*
	180				66261101489				66261101150*
	220				66261101488	66261139389*		66261139367*	
	240				66261101487	66261139388*		66261139366*	66261130331*
	280				66261101486	66261139387*		66261139365*	
	320	50/250				66261139386		66261139364	66261130332
	360					66261139346		66261139363	
	400					66261139385		66261139362	66261130333
500					66261139384		66261139361		
600					66261139383		66261139360	66261130334	
800					66261139382				
1000	50/250					66261139381			
1200						66261139380			
1500						66261139379			
2000						66261139378			
2500						66261139377			

★ P-GRADED

† WATERPROOF





\* PACKAGING STANDARDS: T214, T402, T414, T461 = 50/250

## 9 x 11 Paper Sheet Job Packs

A line of abrasive sheets for general and institutional contractors, and serious do-it-yourselfers.

### Job Packs – Packaging highlights

FEATURES	BENEFITS
<ul style="list-style-type: none"> <li>• Tri-lingual, job-specific application information</li> <li>• Durable packages</li> </ul>	<ul style="list-style-type: none"> <li>• Simplifies selection</li> <li>• Better product visibility; minimize waste and damage</li> <li>• Portable; ideal for showroom merchandising and carrying to the job site</li> </ul>

SIZE	GRIT	STD. PKG.	 BEST NORTON 3X			STD. PKG.	 GOOD MULTISAND*			 GOOD WOODSAND			 GOOD SANDWET†		
			JOB PACK UPC NO.	JOB PACK UPC NO.	JOB PACK UPC NO.		JOB PACK UPC NO.	JOB PACK UPC NO.	JOB PACK UPC NO.	JOB PACK UPC NO.					
9 x 11	36	200*				250•	07660700361								
	50						07660700360								
	60						07660701624								
	80						07660700359			07660701584					
	100						07660700358			07660701583					
	120						07660700357			07660701582					
	150						07660700356			07660701581					
	180						07660700355			07660701580					
	220						07660700354			07660701579					
	320												07660701226		
	400												07660701225		
	600												07660701224		
Assorted												07660701223			

★ P-GRADED

† WATERPROOF

\* PACKED 20 SHEETS PER JOB PACK, 10 JOB PACKS PER STANDARD PACKAGE. • PACKED 25 SHEETS PER JOB PACK, 10 JOB PACKS PER STANDARD PACKAGE. ASSORTED CONTAINS 6 EACH OF 60, 100, 150 GRIT AND 7 EACH OF 220 GRIT.

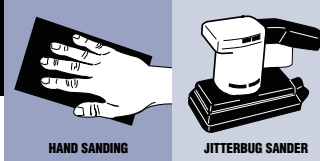

## Paper Sheet Starting Recommendations

MATERIAL	BEST PERFORMANCE	GENERAL DUTY
Unfinished Metal	A275	A251
Primed/Painted Surfaces	A275	A251
Fiberglass/Composites	A275, H875	A251, H290
Bare Wood	A275	A511, A513, A514
Clear Coat Sanding	T402	
Sealer Sanding	A275, A251	A413, A414
Lacquer Sanding	T402, T414, T214	
Wet Sanding	T402, T414, T214	T461
Paint Stripping	A275, H875	A290, H290
Drywall Sanding	Q421	A412
All Purpose Dry Sanding		A212, A213, A211

## Recommended Grit Selection

ROUGHING TO INTERMEDIATE	INTERMEDIATE TO FINISHING	FINE FINISHING	ULTRA FINE FINISHING
36-80	80-240	240-400	400-2500

## Paper Sheet Competitive Cross Reference

NORTON	3M	HERMES	KLINGSPOR	MIRKA	VSM
A211	230U, 240N, 346U	-	-	-	KP31C
A212	210N	HFB	PL31	-	-
A213	230N	HFB	PL31	-	KP31B
A251	316U		PL36	GoldFlex	-
A275	214U, 216U, 334U	HC133, HCAB	PS33	Q-Silver, Royal	-
A290	236U, 316U	HCAB	PS33, PL36	Bulldog Gold	KP911
A413	414N, 415N	PSF-LL, SA167	PL35	Carat(B)	CP131A
A414	404N, 405N, 414N	PSF-LL, SA167	-	FineFlex	CP131A
A511	110N	-	-	-	-
A513	130N	GCAB	-	-	-
A514	140N	GCAB	-	-	-
A621	-	-	-	-	-
H875	750U, 751U, 740I, 745I	-	-	Royal Coarse Cut	KP510E, KP709
T402	401Q	WSFlex18B	PS11	Waterproof (A)	CP918A
T414	413Q	WSFlex18B	PS11	Waterproof (A)	CP918A
T214	213Q	-	PS12	-	-
T461	438Q, 431Q	WSFlex18C	PS11		CP918C

## Paper Sheet Recommended Backing Weight

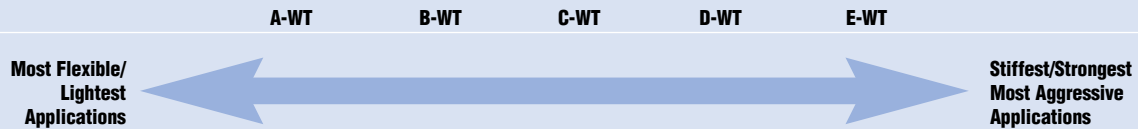

# ABRASIVE SPONGES



Flexible, abrasive sanding sponges for a wide variety of wood, metal, paint, plastic, ceramics and drywall, curved, contoured or flat surface applications.



ABRASIVE SPONGES

## Typical Applications

- Light stock removal
- Sanding sealer and wash-coats
- Touch-up or repair of primer
- Sanding contours, intricate shapes
- Finishing

GOOD Abrasive Sponges	
<b>FEATURES</b>	<b>BENEFITS</b>
• Durable abrasive-coated foam	• Lasts up to 5 times longer than sandpaper; tear-resistant
• Easily conforms to shapes and contours	• Can reach areas inaccessible to sandpaper sheets
• Waterproof, washable	• Reusable; long life

DESCRIPTION/ SIZE W X L X T	GRIT	STD. PKG. (SPONGES/ CASE)	GOOD	
			PACKAGE	UPC NO.
<b>ABRASIVE SPONGES</b>				
<b>FLEXIBLE ABRASIVE SPONGES</b> 3 x 4 x 1/2 Coated on 1 side	60 Coarse	48	Bulk Pack	07660704068
	60 Coarse	108	Bulk Pack	07660701110
	80 Medium	48	Bulk Pack	07660704067
	80 Medium	108	Bulk Pack	07660704070
	100 Medium	48	Bulk Pack	07660704066
	100 Medium	108	Bulk Pack	07660700950
expanded offering!	150 Fine	48	Bulk Pack	07660704065
	150 Fine	108	Bulk Pack	07660700949
	220 Very Fine	108	Bulk Pack	07660704069
	<b>PROFILE SPONGES</b>			
3-3/4 x 2-3/4 x 1/2, Coated on 3 sides	60 Coarse	500	Bulk Pack	63642536314
	100 Medium	500	Bulk Pack	63642536313
<b>SMALL AREA GENERAL PURPOSE SPONGES</b> 4 x 2-3/4 x 1 Coated on 4 sides	36/80 Coarse/Medium	24	Job Pack	07660749505
	36/80 Coarse/Medium	250	Bulk Pack	07660704735
	80/80 Med/Med	24	Job Pack	07660749507
	80/80 Med/Med	250	Bulk Pack	07660701875
expanded offering!	80/120 Medium/Fine	24	Job Pack	07660749504
	80/120 Medium/Fine	250	Bulk Pack	07660702600
	120/120 Fine/Fine	24	Job Pack	07660749506
<b>CONTOUR SINGLE-SIDED SPONGES</b> 4-1/2 x 5-1/2 x 3/16 Coated on 1 side	100 Medium	100	Bulk Pack	07660702257
	150 Fine	100	Bulk Pack	07660702256
	220 Extra Fine	100	Bulk Pack	07660702255
<b>SOFTTOUCH CONTOUR SPONGES</b> 4-1/2 x 5-1/2 x 3/16 Coated on 1 side	60 Medium	80	Bulk Pack	07660703074
	100 Fine	80	Bulk Pack	07660703075
	180 Super Fine	80	Bulk Pack	07660703076
	220 Ultra Fine	80	Bulk Pack	07660703077
<b>SEALER SANDING SPONGES</b> 4-3/4 x 3-3/4 x 1/2 Coated on 2 sides	280 Micro Fine	80	Bulk Pack	07660703078
	60 Very Coarse	250	Bulk Pack	63642536334
	80 Extra Coarse	250	Bulk Pack	63642502538
	100 Coarse	250	Bulk Pack	63642552870
	150 Medium	250	Bulk Pack	63642552869
	220 Fine	250	Bulk Pack	63642552868

NOTE: ORDERS FOR SANDING SPONGES SHOULD BE EXPRESSED PER SPONGE – NOT PER PACK OR CASE. EXAMPLE: TO ORDER A CASE OF FLEXIBLE ABRASIVE SPONGES, ORDER 108 SPONGES.

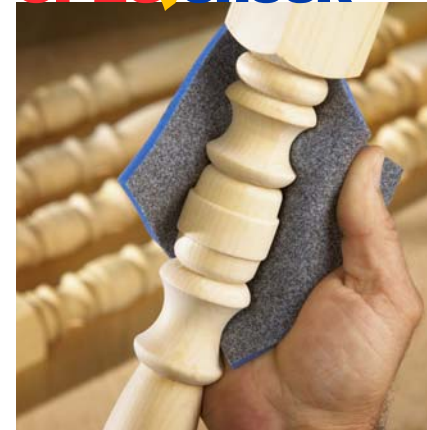

## Application Information

**Flexible:** economical, fabric-backed foam for sanding a variety of materials; coated one side.

**Profile:** for corners and flat surfaces on wood, metal, plastic and paint; coated on three sides

**Small Area General Purpose:** for a wide variety of materials and sanding applications where flexibility is needed; coated four sides.

**Contour Single-sided:** thin, flexible; for sanding small diameters and contours such as ceramics, spindles, turnings and railings; coated one side.

**SoftTouch Contour:** superior flexibility; for hand-sanding or finishing flat, curved, contoured and hard-to-reach areas on wood, metal, composites, paint and solid surfaces; can be used wet or dry; washable; coated one side.

**Sealer Sanding:** very flexible; silicon carbide abrasive for sanding primers, sealers and between coats on furniture and cabinets; coated two sides.

Coated abrasive rolls are designed for fast and easy sanding of various surfaces, and can be torn to exact lengths as needed. Handy rolls are packaged in a protective, convenient dispenser which eliminates costly waste and permits neat, easy storage.

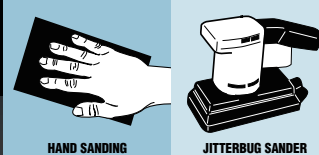

## Typical Applications

### Paper Rolls

- Preparing primed and painted surfaces
- Sanding plastic and fiberglass
- Bare wood sanding
- Ideal for hand/portable sanders

### Cloth Rolls

- Polishing lathe turnings, rolls and cylinders
- Light deburring
- Blending machine tool marks
- Removing rust and scale
- Fine sanding and polishing



## Paper Rolls

### BEST No-Fil Norton SG Dry Ice A975 PSA Paper Rolls – Longest life

FEATURES	BENEFITS
<ul style="list-style-type: none"> <li>• Patented Norton SG ceramic aluminum oxide abrasive, P-graded</li> </ul>	<ul style="list-style-type: none"> <li>• Fastest cut rate; longest life</li> <li>• Consistent finish</li> </ul>
<ul style="list-style-type: none"> <li>• Unique fiber-reinforced, B-wt latex-saturated backing</li> </ul>	<ul style="list-style-type: none"> <li>• 50-60% improvement in tear strength</li> <li>• Flexible; can be used wet</li> </ul>
<ul style="list-style-type: none"> <li>• Water-based stearate, non-pigmented, No-Fil coating</li> </ul>	<ul style="list-style-type: none"> <li>• Provides maximum load resistance and extended life; no color transfer to work</li> </ul>
<ul style="list-style-type: none"> <li>• PSA coated backing</li> </ul>	<ul style="list-style-type: none"> <li>• Easy mounting and removal</li> </ul>
<ul style="list-style-type: none"> <li>• New, increased backing weight for P80, P100 and P120 grits from B-wt to C-wt fiber-reinforced latex</li> </ul>	<ul style="list-style-type: none"> <li>• Increased tear and tensile strength while maintaining flexibility</li> <li>• More durable; longer life in more demanding applications <b>improved!</b></li> </ul>



### BETTER No-Fil Adalox A275 PSA Paper Rolls – Exceptional dry sanding

FEATURES	BENEFITS
<ul style="list-style-type: none"> <li>• Premium P-graded, heat-treated aluminum oxide abrasive</li> </ul>	<ul style="list-style-type: none"> <li>• Superior life; consistent finish</li> </ul>
<ul style="list-style-type: none"> <li>• High strength, B-wt latex backing</li> </ul>	<ul style="list-style-type: none"> <li>• Superior strength, reduced edge-wear</li> </ul>
<ul style="list-style-type: none"> <li>• Non-pigmented stearate (No-Fil), open coat</li> </ul>	<ul style="list-style-type: none"> <li>• Reduces loading, no color transfer to work surface</li> </ul>
<ul style="list-style-type: none"> <li>• PSA coated backing</li> </ul>	<ul style="list-style-type: none"> <li>• Easy mounting and removal</li> </ul>



### GOOD No-Fil Adalox A290 Paper Rolls – Unrivalled durability and value for dry finishing

FEATURES	BENEFITS
<ul style="list-style-type: none"> <li>• P-graded aluminum oxide abrasive</li> </ul>	<ul style="list-style-type: none"> <li>• Increased life, fast cut rate, consistent finish</li> </ul>
<ul style="list-style-type: none"> <li>• Heavy-duty C-wt backing</li> </ul>	<ul style="list-style-type: none"> <li>• Edge-tear resistance, durable</li> </ul>
<ul style="list-style-type: none"> <li>• Stearated (No-Fil), open coat</li> </ul>	<ul style="list-style-type: none"> <li>• Reduced loading</li> </ul>



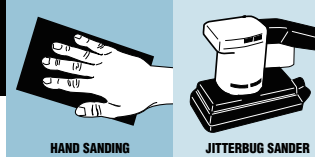

HAND SANDING

JITTERBUG SANDER

## PSA (Pressure Sensitive Adhesive) Paper Rolls

All rolls are measured in inches x yards.

GRIT	MIN./STD. PKG.	BEST A975*			BETTER A275*				GOOD A290*	
		2-3/4" X 25 YDS.	2-3/4" X 30 YDS.	2-3/4" X 45 YDS.	2-3/4" X 25 YDS.	2-3/4" X 30 YDS.	2-3/4" X 45 YDS.	4-1/2" X 10 YDS.	2-3/4" X 20 YDS.	2-3/4" X 25 YDS.
80	1/5	66261149566			66261131691				66261160325	
100			66261148565			66261131690		66261131697		
120			66261149564			66261131689		66261131696		
150							66261131688	66261131695		
180				66261149562			66261131687	66261131694		66261160324
220				66261149561			66261131686	66261131693		66261160323
240							66261131685	66261131692		66261160322
320				66261149558			66261131683			66261160321
400				66261149557			66261131681			66261160352
600							66261131679			

\* P-GRADED

### PSA Roll Dispenser

Designed to accommodate two 2-3/4" PSA rolls, this heavy-duty wire dispenser has a vinyl coating to protect the work surface. They are stackable for multi-grit operations and can be attached to a wall or mounted on a cabinet.



DESCRIPTION	STD. PKG.	UPC NO.
PSA Roll Dispenser	1	63642542773

### PSA Hand Sanding Blocks new!

Their unique ergonomic shape and embossed rubber faces (for good PSA sheet roll adhesion) make these blocks the choice for finishing surfaces. The firm design is constructed of sturdy, high-strength material to produce a true flat surface. The soft design, constructed of flexible, yet tough foam, works well on flat surfaces and contours.



DESCRIPTION	STD. PKG.	UPC NO.
2-3/4 x 5 Soft	5	63642542090
2-3/4 x 5 Firm	5	63642542091
2-3/4 x 7-3/4 Firm	5	63642542094

### Rubber Hand Sanding Block

A resilient rubber block that conforms well to mild contours and flat surfaces. Cut 2-3/4" rolls are securely held by slotted "jaws" at each end of the block to permit quick, easy, roll changes.



DESCRIPTION	STD. PKG.	UPC NO.
2-3/4 x 5	5	07660701889



### FastTrack Rolls

Norton offers FastTrack delivery on your customized, made-to-order R228 and K225 fifty-yard rolls. Contact your local distributor or Norton sales representative for details.

#### Description

- Width: 2" – 12"
- Length: 50 yards
- Leadtime: 5 days
- Aluminum Oxide Cloth, R228, K225

#### Ordering

- Include a full description of roll required, including:
  - Size
  - Specification
  - Grit size
  - Quantity

#### FastTrack Roll Quantity Availability

Width	Minimum Qty.	Maximum Qty.
2" to <3"	5 Rolls	10
3" to <4"	4 Rolls	8
4" to <5"	3 Rolls	6
5" through 7"	2 Rolls	4
>7" through 12"	1 Roll	2

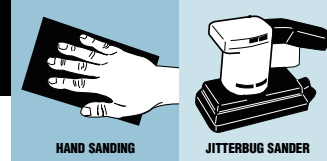

HAND SANDING

JITTERBUG SANDER

## Cloth Rolls

### GOOD Metalite K225 Cloth Rolls – For general purpose metalworking applications

FEATURES	BENEFITS
• Premium P-graded aluminum oxide abrasive	• Greater cut rate than competitive products
• Flexible J-wt cotton backing	• Superior conformability to complex surfaces and better finishes
• Advanced full resin bond system	• Exceptional grain adhesion for longer life
• <b>new!</b> 40 grit offering	• Quick, clean action

expanded offering!



### GOOD Lightning Metalite K227 Cloth Rolls – The choice for quality metal finishing

FEATURES	BENEFITS
• P-graded aluminum oxide abrasive grain	• Fast cut rate and consistent finish
• Flexible J-wt cotton backing	• Superior conformity to complex surfaces and better finishes
• Resin bond system	• Longer life
• <b>new!</b> 100 and 150 grit offering	• Smooth finishes

expanded offering!



### GOOD Screen-Bak Durite Q421 Rolls – Washable, ideal for drywall applications

FEATURES	BENEFITS
• P-graded silicon carbide on open mesh backing	• Extreme resistance to loading when removing scale, rust and corrosion
	• Waterproof



## Handy Rolls and Other Cloth Rolls

All rolls measured in inches x yards.

GRIT	MIN./STD.PKG.	GOOD K225*				
		1" X 10 YDS.	1" X 50 YDS.	1-1/2" X 50 YDS.	2" X 50 YDS.	4" X 50 YDS.
40 <b>new!</b>	1/5		66261058716*	66261058715*	66261058714*	
50			66261127728*	66261127730*	66261127732*	
60			66261127729*	66261127731*	66261127733*	
80		66261134298	66261126276	66261126288	66261126299	
100		66261134299	66261126275	66261126287	66261126298	
120		66261134300	66261126274	66261126286	66261126297	66261127285
150		66261134301	66261126273	66261126285	66261126296	
180		66261134302	66261126272	66261126284	66261126295	
220			66261126271	66261126283	66261126294	
240		66261134303	66261126270	66261126282	66261126293	
280			66261126269	66261126281	66261126292	
320		66261134304	66261126268	66261126280	66261126291	
400			66261126267	66261126279	66261126290	
600			66261126266	66261126278	66261126289	

GRIT	MIN./STD.PKG.	GOOD K227*			GOOD Q421*†	
		1" X 50 YDS.	1-1/2" X 50 YDS.	2" X 50 YDS.	1-1/2" X 25 YDS.	2" X 25 YDS.
80	1/5	66261109180	66261109255	66261109335	66261107275**	
100 <b>new!</b>		66261058721	66261058719	66261109330		
120		66261109170	66261109245	66261109325	66261107270**	66261149811**
150 <b>new!</b>		66261058720	66261058717	66261109320		
180		66261109160	66261109235	66261109315	66261107265**	
240			66261109225	66261109305		
280		66261109150				
320		66261109140	66261109215	66261109295		

\* P-GRADED  
 † WATERPROOF  
 \* SUPPLIED IN METALITE K224 – P-GRADED  
 \*\* PACKAGING STANDARDS:  
 MIN. QTY./STD. PKG.: Q421: 1/10

## TECHtip



Use light machine oil with cloth rolls as a lubricant for finer finishes and quicker cut.

! It is the user's responsibility to refer to and comply with ANSI B7.7

# BEAR-TEX DISCS AND DC WHEELS

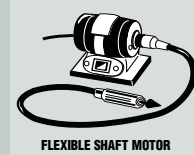

## Bear-Tex Rapid Finish Depressed Center Wheels, Rapid Strip Discs and Depressed Center Wheels

A web of strong synthetic fibers and quality abrasive, bonded together by a smear-resistant adhesive for cleaning, conditioning, and finishing a multitude of materials, quickly and easily with little loading.

### Typical Applications

#### Rapid Strip

- Removal of paint and epoxy coating, surface rust and residue, corrosion, light weld splatter, dirt, mill scale and other similar surface contaminants
- Surface prep before coatings are applied
- Surface prep before welding; cleaning and conditioning afterwards
- Applying fine finishes

#### Rapid Finish

- Prepping surfaces
- Removing light scale on electrical power generation components, composite and fiberglass resins, surface impurities from aluminum tubing, weld discoloration, and overspray from powercoating or painting
- Cleaning and polishing stainless steel, ferrous and nonferrous metal surfaces, injection molds, and paper mill rolls



### BEST Bear-Tex Rapid Strip Discs and Depressed Center Wheels

FEATURES	BENEFITS
• Open web construction	• Fast cutting action with very little loading
• Conformable	• Follow difficult part profiles • Easy cleaning of uneven surfaces
• Thick, strong, synthetic fibers and extra coarse grit	• Quick cleaning and conditioning of surfaces
• Used with portable tools	• Easy and safe to use especially in difficult to reach areas
• 2" and 3" discs with Speed-Loc TR fastener	• Quick, tool-free disc changes allow for more grinding time
• 4" TR+ discs	• Quick-change replacement; can be used on face and edge



### BEST Bear-Tex Rapid Finish Depressed Center Wheels

FEATURES	BENEFITS
• Fine grain particle concentration cleans and polishes while imparting final finishes on a variety of materials	• Increases productivity and reduces total abrasive costs by eliminating a grinding step
• Advanced resin system	• Resists loading; smear-free, clean, fine finishes
• Low density	• Conformable and flexible
• Undersized backing	• Maximizes grinding area and usage for longer life
• NEX 2AM	• Most aggressive
• NEX 2AF	• Multi-purpose
• NEX 2SF	• Polishing
• A/O Medium High Strength	• Less aggressive, most conformable

new!



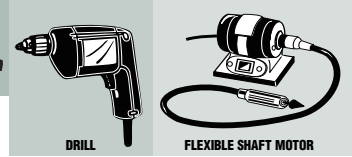
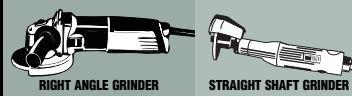

## Bear-Tex Rapid Strip Discs

SIZE D X H	ABRASIVE	GRIT SIZE	MAX. RPM	STD. PKG.	BEST
					UPC NO.
2" Speed-Lok TR	Silicon Carbide	Extra Coarse	15,500	10	66261013402
3" Speed-Lok TR	Silicon Carbide	Extra Coarse	12,000	10	66261013403
4" Speed-Lok TR+	Silicon Carbide	Extra Coarse	8,000	10	66261016580
4 x 1/4	Silicon Carbide	Extra Coarse	8,000	25	66261008008
4 x 1/2	Silicon Carbide	Extra Coarse	8,000	25	66261007916
6 x 1/2	Silicon Carbide	Extra Coarse	5,500	15	66261008051

See page 113 for Speed-Lok back-up pads.

## Mandrel Assemblies for Rapid Strip Discs and Discs-On-Edge

FITS HOLE	FOR DISC WIDTH	FOR DISC DIAMETER	SHANK DIAMETER	OVERALL LENGTH	WASHER DIAMETER	STD. PKG.	UPC NO.
1/4"	1/2" (Standard)	up to 6"	1/4"	2-1/2"	1-1/2"	1	66261009502
1/2"	1/2" (Standard)	Up to 8"	1/4"	3-1/8"	2-1/4"	1	66261059420



## Bear-Tex Rapid Strip and Rapid Finish Depressed Center Wheels

Rapid Finish depressed center wheels will work anywhere Rapid Strip products work. Use Rapid Finish when a less aggressive product is needed.

SIZE D X H	MAX. RPM	STD. PKG.	BEST		
			RAPID STRIP UPC NO.	RAPID FINISH UPC NO.	
4-1/2 x 5/8-11	12,000	10	S/C ExC 66261009585	BEST <b>new!</b>	
				NEX-2AM	66261023947
				NEX-2AF	66261023946
				NEX-2SF	66261023943
4-1/2 x 7/8	12,000	10	S/C ExC 66261009649	BEST <b>new!</b>	
				A/O Medium High Strength	66261023949
				NEX-2AM	66261020548
				NEX-2AF	66261020547
7 x 5/8-11	8,000	10	S/C ExC 66261009650	BEST <b>new!</b>	
				NEX-2SF	66261020546
7 x 7/8	8,000	10	S/C ExC 66261009586	BEST <b>new!</b>	
				A/O Medium High Strength	66261020549

## Bear-Tex Abrasive Brushes

Tough, flexible nylon filaments embedded with abrasive grain form the bristles of these brushes. Use Bear-Tex abrasive brushes where maximum conformability is needed.



SIZE D X R X H*	ABRASIVE	GRIT	MAX. RPM	STD. PKG.	GOOD
					UPC NO.
7 x 1 x 7/8	Silicon Carbide	80	6,000	5	66261058830
					66261058834

\*DIAMETER X RIM WIDTH X HOLE

## Air-Cooled Rubber Back-up Pad and Retainer Nut for Abrasive Brushes

DESCRIPTION	MAX. RPM	STD. PKG.	UPC NO.
7" Firm Pad	6,000	5	63642543425
#103 Retainer Nut	—	10	63642543463



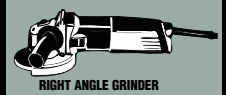

## AVOS Edger Speed-Lok Bear-Tex Discs

Made of non-woven nylon web impregnated with abrasive grain and resin for use in a variety of applications. Choose one of three grit specifications to achieve the best results for your application.

### Typical Applications

- Light deburring
- Cleaning and rust removal
- Finishing, polishing and paint preparation



### BETTER AVOS – Allows View Of Surface – Edger Speed-Lok Bear-Tex Discs

FEATURES	BENEFITS
<ul style="list-style-type: none"> <li>• Patented hole design</li> </ul>	<ul style="list-style-type: none"> <li>• Allows interrupted cut which reduces heat up to 30% over standard round discs</li> <li>• Cool cutting results in longer disc life</li> <li>• Provides complete vision into the grinding zone</li> <li>• Operators can grind more accurately with less re-work</li> </ul>
<ul style="list-style-type: none"> <li>• Scooped holes</li> </ul>	<ul style="list-style-type: none"> <li>• Create air flow to pull loose abrasive and swarf away from work surface grinding zone – resulting in extended disc life</li> </ul>
<ul style="list-style-type: none"> <li>• 15 degree angle back-up pad</li> </ul>	<ul style="list-style-type: none"> <li>• Grinding at 5°-15° angle allows greater utilization of disc surface</li> <li>• Eliminates gouging of workpiece</li> </ul>
<ul style="list-style-type: none"> <li>• Coarse removes 60 – 120 grit grindlines</li> </ul>	<ul style="list-style-type: none"> <li>• For light deburring</li> </ul>
<ul style="list-style-type: none"> <li>• Medium removes 120 – 180 grit grindlines</li> </ul>	<ul style="list-style-type: none"> <li>• For cleaning and rust removal</li> </ul>
<ul style="list-style-type: none"> <li>• Very Fine removes 180 – 320 grit grindlines</li> </ul>	<ul style="list-style-type: none"> <li>• For finishing, polishing and paint preparation</li> </ul>



See page 54 for AVOS back-up pads.

SIZE	ABRASIVE/ GRIT	STD. PKG.	BETTER
			UPC NO.
<b>AVOS EDGER SPEED-LOK BEAR-TEX DISCS</b>			
4-1/2 Edger Speed-Lok	A/O Coarse	40	66261010447
	A/O Medium		66261010448
	A/O Very Fine		66261010449
5 Edger Speed-Lok	A/O Coarse	40	66261009427
	A/O Medium		66261009428
	A/O Very Fine		66261009429
7 Edger Speed-Lok	A/O Coarse	40	66261009430
	A/O Medium		66261009431
	A/O Very Fine		66261009432

# BEAR-TEX DISCS AND BELTS

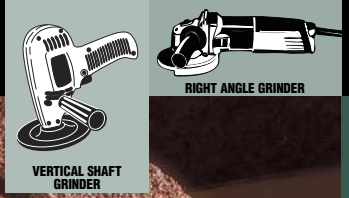

## Bear-TEX Surface Blending STE Discs and Belts

Norton Bear-TEX surface blending material is available in all three tiers. With three different stock product lines, and grit sizes of extra coarse to very fine, STE discs and belts perform well under a wide range of applications: from removing engine gaskets, and deburring of aluminum and steel, to finishing nickel alloy turbine blades.

### Typical Applications

- Removing surface defects
- Removing light edge burrs, parting lines or flashing
- Removing rust, oxides, corrosion, paints and scale
- Cleaning molds
- Blending mill marks, tool marks, uneven edges and coated abrasive finish

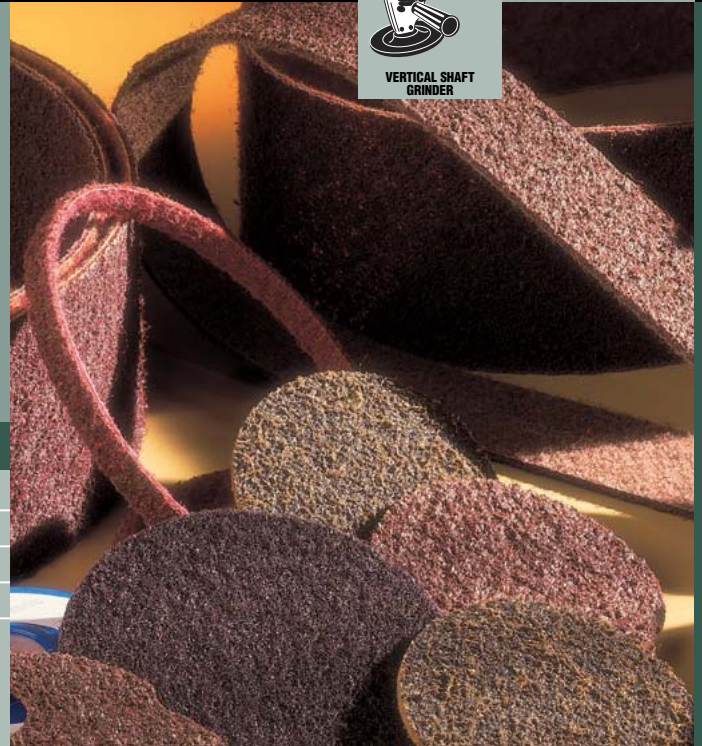

Bear-TEX STE Discs and Belts	
FEATURES	BENEFITS
• Color-coded grit sizes	• Easy identification and matching of product with application and finish requirement
• Conformable	• Conform to workpiece; forgiving
• Uniform, thorough abrasive coating	• Consistent finish
• Disc configurations: Hook and Loop; TR and TS Speed-Lok	• Can be used on a wide variety of industrial and commercial tools
• Belt configurations: up to 37" width; Plyweld, butt joint; low stretch backing available	• Speed-Lok provides quick and easy on and off

BEST Bear-TEX STE-CS Discs – Work best on harder materials	
FEATURES	BENEFITS
• Closed structure	• Long lasting
• Very sharp abrasive grain	• High, continuous cut rate
• Rigid, low stretch backing	• Excellent performance on hard materials (steels, nickel, alloys, etc.)
• Extra Coarse and Medium stock grit sizes	• Two degrees of aggressiveness and surface finishing

BETTER Bear-TEX STE-VS Discs and Belts – Great multi-purpose product	
FEATURES	BENEFITS
• Slightly open structure	• Resists loading and chunking
• High abrasive content	• Continuous cut rate on soft (e.g. aluminum) and hard materials (e.g. steels and nickel alloys)
• Firm backing	• Low stretch
• Coarse, Medium and Very Fine stock grit sizes	• Three degrees of aggressiveness and surface finishing

GOOD Bear-TEX STE Discs and Belts – Ideal for soft materials and low force applications	
FEATURES	BENEFITS
• Open structure	• Resists loading on softer materials (aluminum, gaskets, etc.)
• High abrasive content	• Fast initial cut rate
• Flexible backing	• Conformable
• Coarse, Medium and Very Fine stock grit sizes	• Three degrees of aggressiveness and surface finishing

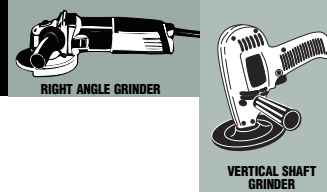

## Bear-Tex Surface Blending STE Discs

SIZE	ABRASIVE	GRIT SIZE	STD. PKG.	BETTER STE-VS	GOOD STE
				UPC NO.	UPC NO.
<b>WITH HOOK AND LOOP FASTENING SYSTEM</b>					
2" Blank	A/O	Coarse	80	66261004431	
	A/O	Medium		66261004441	
	A/O	Very Fine		66261004451	
3" Blank	A/O	Coarse	60	66261004432	
	A/O	Medium		66261004442	
	A/O	Very Fine		66261004452	
4" Blank	A/O	Coarse	40	66261004433	66261055018
	A/O	Medium		66261004443	66261055019
	A/O	Very Fine		66261004453	
4-1/2" Blank	A/O	Coarse	40	66261004434	66261017806
	A/O	Medium		66261004444	66261017807
	A/O	Very Fine		66261004454	
5" Blank	A/O	Coarse	40	66261004435	66261055021
	A/O	Medium		66261004445	66261055022
	A/O	Very Fine		66261004455	
6" Blank	A/O	Coarse	30	66261006910	
	A/O	Medium		66261006911	
	A/O	Very Fine		66261006912	
7" Blank	A/O	Coarse	25	66261004436	66261055027
	A/O	Medium		66261004446	66261055028
	A/O	Very Fine		66261004456	
8" Blank	A/O	Coarse	20	66261006913	
	A/O	Medium		66261006914	
	A/O	Very Fine		66261006915	



SIZE	ABRASIVE	GRIT SIZE	STD. PKG.	BEST STE-CS	BETTER STE-VS	GOOD STE	
				UPC NO.	UPC NO.	UPC NO.	
<b>WITH SPEED-LOK TS FASTENING SYSTEM</b>							
2" Speed-Lok	A/O	Extra Coarse	50	66261017819	66261004439	66261009183	
	A/O	Coarse		66261017528		66261009182	
	A/O	Medium				66261004459	66261009181
	A/O	Very Fine					
3" Speed-Lok	A/O	Extra Coarse	25	66261017818	66261004440	66261009186	
	A/O	Coarse		66261017817		66261009185	
	A/O	Medium				66261004450	66261009184
	A/O	Very Fine				66261004460	
4" Speed-Lok	A/O	Coarse	25		66261055349		
	A/O	Medium			66261055350		
<b>WITH SPEED-LOK TR FASTENING SYSTEM</b>							
2" Speed-Lok	A/O	Extra Coarse	50	66261016373	66261004437	66261009191•	
	A/O	Coarse		66261016763		66261009190•	
	A/O	Medium				66261004457	66261009189•
	A/O	Very Fine					
3" Speed-Lok	A/O	Extra Coarse	25	66261016994	66261004438	66261009194	
	A/O	Coarse		66261016995		66261009193	
	A/O	Medium				66261004458	66261009192
	A/O	Very Fine					
4" Speed-Lok	A/O	Coarse	25		66261008822		
	A/O	Medium			66261008821		
	A/O	Very Fine			66261008820		

• PACKAGING STANDARDS: 2" STE TR DISCS STD. PKG. = 25

If you do not see the STE disc you need in our stock offering, call your local Norton distributor to check for made-to-order availability.

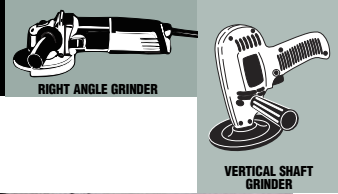

## SPECcheck

### STE Disc and Belt Performance

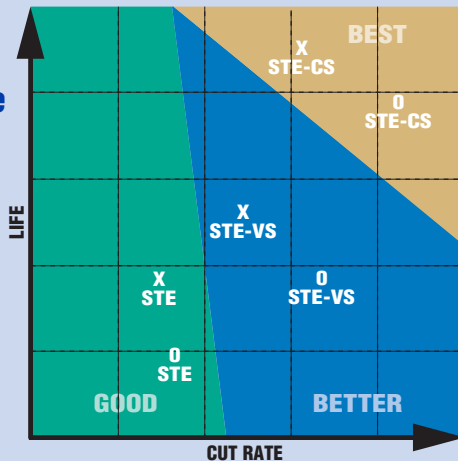

O = HIGH FORCE APPLICATIONS  
X = LOW FORCE APPLICATIONS

**STE-CS** – aggressive, closed structure, very sharp; works best on harder materials, low- and high-force applications.

**STE-VS** – great multi-purpose, works great for a variety of materials

**STE** – more open structure; excellent on soft materials and low force applications.



### Surface Finish



## Back-up Pads for Bear-Tex Discs

PAD DIAMETER	SPINDLE OR HOLE SIZE	MAX. RPM	3M EQUIVALENT	STD. PKG.	UPC NO.
<b>BACK-UP PADS FOR HOOK &amp; LOOP DISCS</b>					
2	1/4 Steel Shank	23,000	922	5	66261059352
3	1/4 Steel Shank	20,000	923	5	66261059354
4	1/4 Steel Shank	18,000	924	5	66261059356
	1/2-13	13,000	914		66261059303
	5/8-11		914		66261059304
	M10 x 1.250				66261059305
4-1/2	5/8-11	10,000	9145	5	66261006948
5	5/16-24 Male	10,000	905	5	66261059360
	3/8-24 Male		905		66261059308
	5/8-11		915		66261059310
6	5/8-11	8,000	916	5	66261059312
7	5/8-11	6,000	917	5	66261059368
8	5/8-11	4,500	918	5	66261059372

PAD DIAMETER	DESCRIPTION	MAX. RPM	STD. PKG.	UPC NO.
<b>BACK-UP PADS FOR SPEED-LOK DISCS</b>				
2	Hard Speed-Lok TS Back-up Pad	30,000	10	63642543205
	Medium Speed-Lok TS Back-up Pad	25,000	10	63642543210
	Medium Speed-Lok TR Back-up Pad	25,000	10	66261055103
3	Hard Speed-Lok TS Back-up Pad	20,000	10	63642543220
	Medium Speed-Lok TS Back-up Pad	20,000	10	63642543225
	Hard Speed-Lok TR Back-up Pad	20,000	10	63642504900
	Medium Speed-Lok TR Back-up Pad	20,000	10	66261055105
4	Medium Speed-Lok TS Back-up Pad	12,000	10	66261043232
	Hard Speed-Lok TR Back-up Pad	12,000	10	63642502912
	Medium Speed-Lok TR Back-up Pad	12,000	10	66261047581
	Speed-Lok TR+ Back-up Pad	8,000	1	66261016581

### BEAR-TEX DISC ATTACHMENT SYSTEMS



**SURFACE BLENDING STE DISCS** FEATURE A HOOK & LOOP FASTENING SYSTEM.



**SPEED-LOK TS DISCS** ARE COMPATIBLE WITH THE NORTON SPEED-LOK TS AND STANDARD® ABRASIVES QUICK CHANGE FASTENING SYSTEMS.



**SPEED-LOK TR DISCS** ARE COMPATIBLE WITH THE NORTON SPEED-LOK TR AND 3M ROLOC® FASTENING SYSTEMS.

# BEAR-TEX BELTS AND FLAP WHEELS

## Bear-Tex Surface Blending STE Belts

SIZE	ABR.	GRIT SIZE	STD. PKG.	BETTER STE-VS	GOOD STE
				UPC NO.	UPC NO.
1/2 x 18	A/O	Coarse	24	66261009048	66261055309
	A/O	Medium		66261008814	66261055310
	A/O	Very Fine		66261006762	66261055311
1/2 x 24	A/O	Coarse	24	66261008972	66261055312
	A/O	Medium			66261055313
	A/O	Very Fine			66261055314
3/4 x 18	A/O	Coarse	12	66261008813	66261055324
	A/O	Medium			
3-1/2 x 15-1/2	A/O	Coarse	8		66261055326
	A/O	Medium			66261055330
	A/O	Very Fine			66261055331
6 x 48	A/O	Coarse	4		66261055332
	A/O	Medium			66261055331
	A/O	Very Fine			66261055332
2 x 132	A/O	Coarse	6	66261017512	66261008492
	A/O	Medium		66261008492	

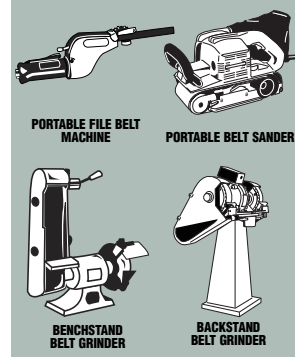

If you do not see the STE and STE-VS belts you need in our stock offering, call your local Norton distributor to check for made-to-order availability.

## SPECcheck

### Starting Recommendations

HEAVY-DUTY CLEANING/ BLENDING	DEBURRING	CLEANING/ BLENDING	FINISHING
Extra Coarse (Brown)	Coarse (Brown)	Medium (Maroon)	Very Fine (Blue)

## TECHtips

- For removing 60 to 120 grit grindlines – use coarse grit (brown)
- For removing 120 to 180 grit grindlines – use medium grit (maroon)
- For removing 180 to 320 grit grindlines – use very fine grit (blue)



It is the user's responsibility to comply with safety regulations.

## Bear-Tex Flap Wheels

A very conformable Bear-Tex product, flap wheels provide a cushioning action which is ideal for use on uneven or irregular surfaces as well as flat areas.

### Typical Applications

- Cleaning threaded parts
- Removing oxide from printed circuit boards
- De-glossing plastic parts
- Producing uniform finishes on aluminum, brass and stainless steel
- Can be used on automatic and robotic equipment



# BEAR-TEX FLAP WHEELS

## Bear-Tex Spindle-Mounted Flap Wheels

Interleaf flap wheels consist of alternating flaps of aluminum oxide coated abrasive cloth and medium grit Bear-Tex material. The interleaf product is less conformable than a standard Bear-Tex flap wheel and will remove more material.

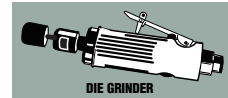

SIZE D X T X SPINDLE	BEAR-TEX ABRASIVE/ GRIT	MAX. RPM	STD. PKG.	BETTER
				UPC NO.
<b>BEAR-TEX FLAP WHEELS – SPINDLE-MOUNTED</b>				
2 x 1 x 1/4" Spindle	A/O Medium A/O Very Fine	12,000	20	66261051716 66261051717
3 x 1 x 1/4" Spindle	A/O Medium A/O Very Fine	12,000	20	66261051718 66261051719
3 x 2 x 1/4" Spindle	A/O Medium	8,000	10	66261058474

SIZE D X T X SPINDLE	COATED ABRASIVE/ GRIT	MAX. RPM	STD. PKG.	BETTER
				UPC NO.
<b>BEAR-TEX INTERLEAF FLAP WHEELS – SPINDLE-MOUNTED</b>				
2 x 1 x 1/4" Spindle	A/O 60 A/O 80 A/O 120	12,000	20	66261051720 66261051721 66261051722
3 x 1 x 1/4" Spindle	A/O 120	12,000	20	66261051725

## Bear-Tex Flap Wheels

SIZE D X T X H	BEAR-TEX ABRASIVE/ GRIT	DENSITY	MAX. RPM	STD. PKG.	BETTER
					UPC NO.
<b>BEAR-TEX FLAP WHEELS</b>					
6 x 1 x 2	A/O Medium A/O Fine S/C Fine S/C Very Fine	Medium Medium Medium Medium	3,000	4	66261058456 66261058487 66261058451 66261058450
8 x 1 x 3	A/O Fine	Medium	2,500	3	66261058491
8 x 2 x 3	A/O Medium A/O Fine	Hard Medium	2,500	2	66261000889 66261058493
12 x 2 x 5	A/O Med. High Strength	Medium	1,900	1	66261005070

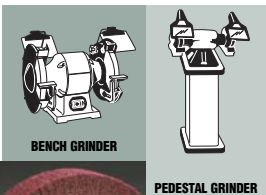

SIZE D X T X H	COATED ABRASIVE/ GRIT	DENSITY	MAX. RPM	STD. PKG.	BETTER
					UPC NO.
<b>BEAR-TEX INTERLEAF FLAP WHEELS</b>					
6 x 1 x 2	A/O 80 A/O 120 A/O 180	Medium Medium Medium	3,000	4	66261004418 66261007678 66261005387
8 x 1 x 3	A/O 120	Medium	2,500	3	66261010711
12 x 1 x 5	A/O 80 A/O 120	Medium Medium	1,900	2	66261010712 66261004667

Refer to "Bear-Tex Convolute Wheels" section, for flap wheel reducing bushings.

## TECHtips

Interleaf flap wheels must always be run in the direction indicated by the arrow printed on the product.



It is the user's responsibility to comply with all safety regulations.