

# BUMPERS

## ROUND TUBING BUMPER

## SQUARE TUBING BUMPER

3" OUTSIDE DIAMETER		3" OUTSIDE DIAMETER	
	Number		Number
5/8" Diam. I.D.	A-8400	7/8" Square I.D.	A-8409
3/4" Diam. I.D.	A-8401	1" Square I.D.	A-8410
7/8" Diam. I.D.	A-8402		
1" Diam. I.D.	A-8403		
1-1/4" Diam. I.D.	A-8404		
Weight 3 oz. each.		Weight 4 oz. each.	
5" OUTSIDE DIAMETER		5" OUTSIDE DIAMETER	
	Number		Number
3/4" Diam. I.D.	A-6355	7/8" Square I.D.	A-8847
1" Diam. I.D.	A-2270	1" Square I.D.	A-7668
1-1/4" Diam. I.D.	A-2274	1-1/4" Square I.D.	A-4953
1-1/2" Diam. I.D.	A-2275	1-1/2" Square I.D.	A-2272
1.9" Diam. I.D.	A-2276	1-5/8" Square I.D.	A-5375
		1-3/4" Square I.D.	A-6147
		2" Square I.D.	A-2273
		1-5/8" x 1-13/16 Rectangle	A-2271
Weight 12 oz. each.		Weight 12 oz. each.	

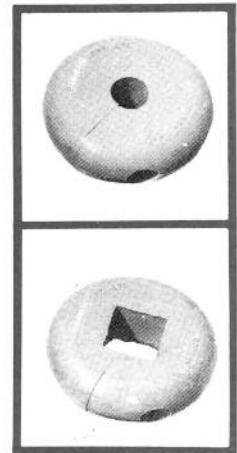

## DOUGHNUT AND CORNER BUMPERS

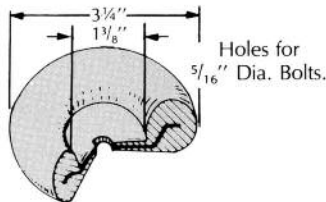

**A-813 DOUGHNUT BUMPERS.** Commonly installed on the ends of tubular handles to give needed protection in manipulation of equipment. Note steel insert. Attached to wood with wood screws or to metal with rivets, bolts or metal screws. Weight 6 oz. each.

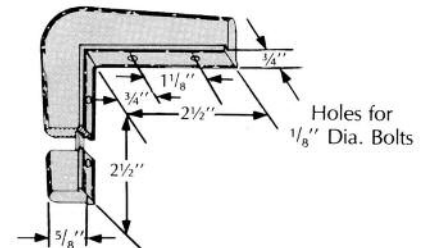

**A-2680 CORNER BUMPER.** Made especially for use with A-1541 Strip Bumper, giving a uniform continuous effect all around the equipment. Weight 5 oz. each.

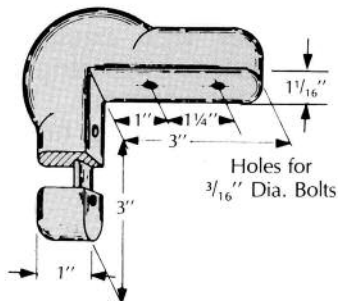

**A-833 CORNER BUMPERS.** Made to give adequate protection to all surfaces that may be contacted, such as doors, doorfacings, walls, furniture and other equipment. Easily attached by using self-tapping sheet metal screws. Weight 6 oz. each.

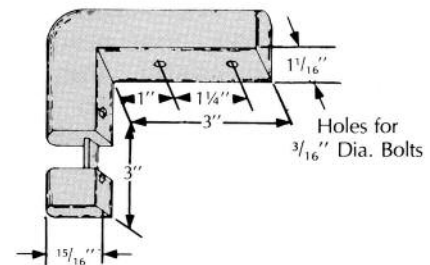

**A-1676 CORNER BUMPERS.** Made especially for use with A-567 Strip Bumper, giving a uniform continuous effect all around the equipment. Weight 5 oz. each.

## TIRING

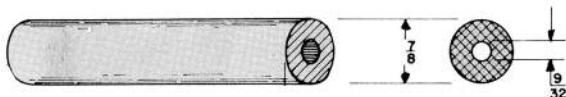

**GREY 7/8" TIRING** is compounded for use on wheelchairs and other similar wheels. Has very good wearing qualities and will withstand rough use. Tiring can be supplied in lengths up to 250 ft. Weight 5 oz./ft. Black also available.

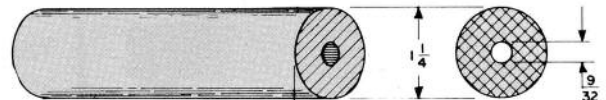

**GREY 1-1/4" TIRING** is compounded for use on wheelchairs and other similar wheels. Has very good wearing qualities and will withstand rough use. Tiring can be supplied in lengths up to 250 ft. Weight 8 oz./ft. Black also available.

**BUMPERS - ( WITH OR WITHOUT INSERTS ) - CAN BE PROVIDED IN SPECIAL LENGTHS**

# BUMPERS

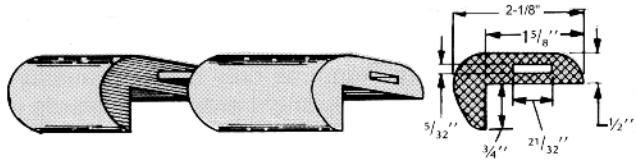

**MODEL A-2041** provides excellent protection for desk and table edges, etc. Maximum lengths 16 ft. for easy installation. Metal insert optional. Wt. 14 oz./ft.

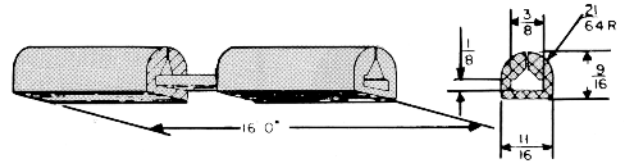

**MODEL A-4652** is a flat-based rubber strip bumper with split top for easier installation. Wt. 4 oz./ft. Metal insert optional.

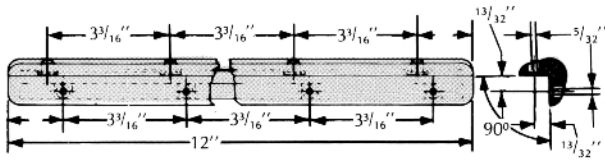

**MODEL A-4925** is a molded strip corner bumper 12" long, for application to any right angle shape. Easily installed with self tapping metal screws. Wt. 8 oz. ea.

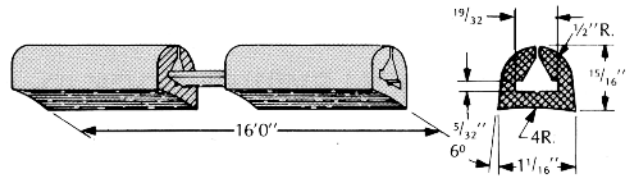

**MODEL A-2084** is a flat based rubber strip bumper designed for same use as A-567. With split top for easier installation. Wt. 9 oz./ft. Metal insert optional.

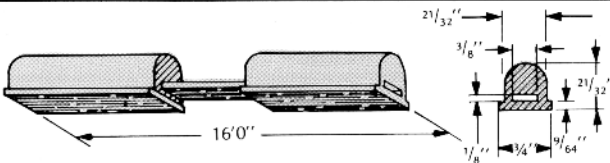

**MODEL A-1541** is a very popular small-sized strip bumper that is adaptable to many applications. This model is easily applied to equipment. Wt. 4 oz./ft. Metal insert optional.

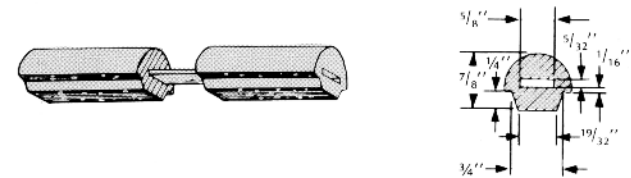

**MODEL A-1023** is used with 1" Commercial channel iron, but is designed for lighter service, eliminating unnecessary weight. Will pay for itself many times over. Wt. 12 oz./ft. Metal insert optional.

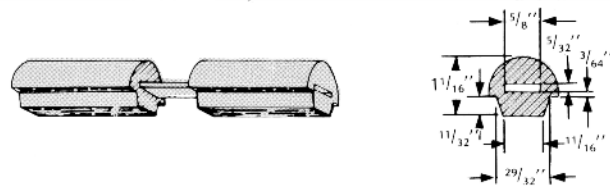

**MODEL A-1019** made especially for 1-1/4" Commercial channel iron is used for heavier type equipment where strength is necessary for operation. Gives that extra needed protection. Wt. 12 oz./ft. Metal insert optional.

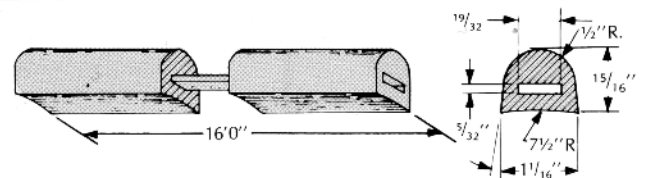

**MODEL A-567** is a flat-based rubber strip designed for installation on either metal or wood surfaces. This model is easily applied and does not require a special channel. Wt. 9 oz./ft. Metal insert optional.

## REVOLVING BUMPERS MOLD-ON HEAVY DUTY RUBBER BUMPERS

3" DIA.	4" DIA.	5" DIA.
3/8" Wide Face Weight 6 oz. ea.	3/8" Wide Face Weight 8 oz. ea.	1/2" Wide Face Weight 11 oz. ea.
A-4468	A-6478	A-7569

DIA. INCHES	WEIGHT	MODEL NUMBER
4"	5 oz.	A-4940
5"	12 oz.	A-4941
7"	26 oz.	A-4597
7-1/2"	28 oz.	A-4820
8-1/2"	42 oz.	B-6487



REVOLVING BUMPERS are designed to fit on a caster stem and prevent the bed or other article of furniture on which they are used, from striking the wall. The bumper will strike the wall first and, if the bed is moved along the wall, the bumper will revolve, thus eliminating any chance of smearing the wall or causing an erasure. Made from grey non-marking rubber. When ordering Revolving Bumpers, specify either 7/16" or 5/8"

Designed to fit almost every type of portable equipment requiring heavy duty bumpers. These solid rubber bumpers with a heavy steel insert are made of grey (non-marking) rubber molded around the steel insert, making the entire unit virtually indestructible and long lasting. The machines steel hubs are made in the following standard stem sizes: 7/16", 1/2", 9/16", 5/8", 3/4", 13/16", 7/8" and 1". Other sizes available on request.



**BUMPERS - ( WITH OR WITHOUT INSERTS ) - CAN BE PROVIDED IN SPECIAL LENGTHS**