

# 2C-PSS Polished Stainless Steel

## Best Value Standard & Stainless Steel Institutional Casters for Every Application

- AALAS
- Animal Cages
- Hotel & Catering Equipment
- Movable Hi-tech Products
- Institutional Equipment
- Movable Furniture
- Medical Equipment
- Kitchen Equipment
- Laboratories
- Clean Room
- Apparatus
- Trollys

### 02CSS POLISHED STAINLESS STEEL pressed steel double ballrace swivel yoke

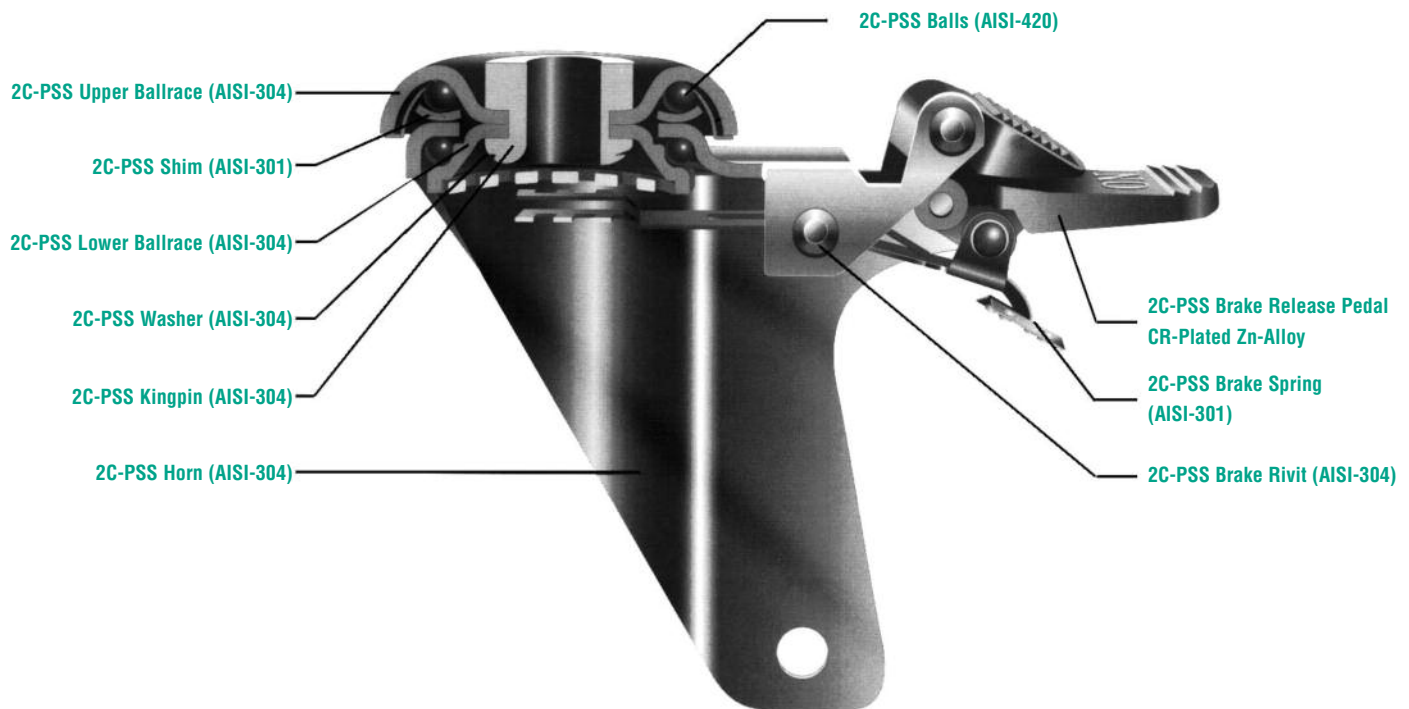

### 2C-PSS AXLE & NUT (STAINLESS STEEL)

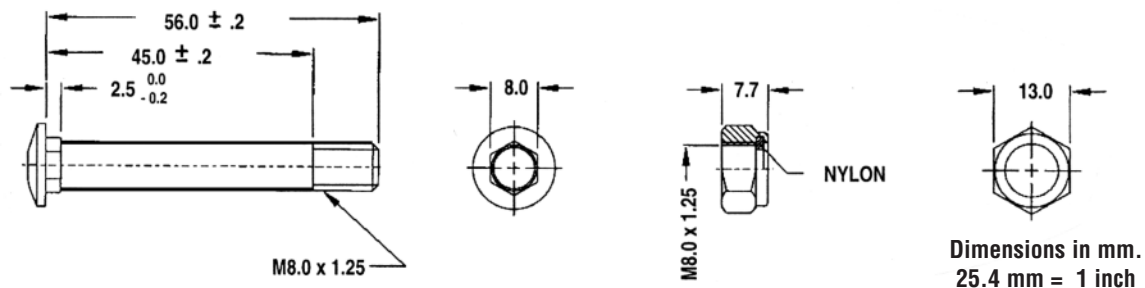

# 2C-PSS Polished Stainless Steel

## 2C-PSS FEATURES

### Load Capacity Up to 275 lbs.

- Electro Plated Stainless Steel Housing
- Stainless steel double ball raceway with hardened main raceway shim and hardened steel balls
- Steel thread guards available on select wheel types

## BRAKE OPTIONS

- SSTL** Stainless Steel Total Lock  
**DL** Plastic Directional Lock

## TOP PLATES

- P1** US  
**P2** Euro  
**P3** US



## SWIVEL TOP PLATES (Dimensions are in mm. 25.4mm = 1mm)

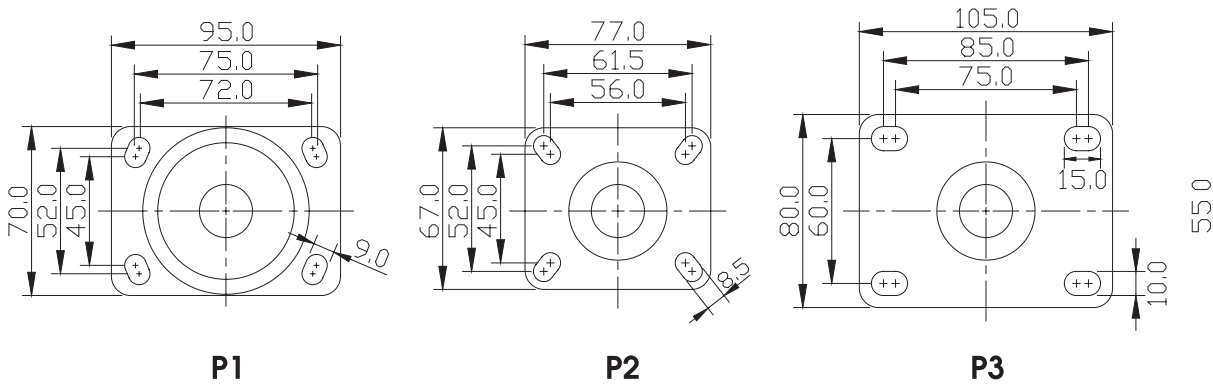

## RIGID TOP PLATES (Dimensions are in mm. 25.4mm = 1mm)

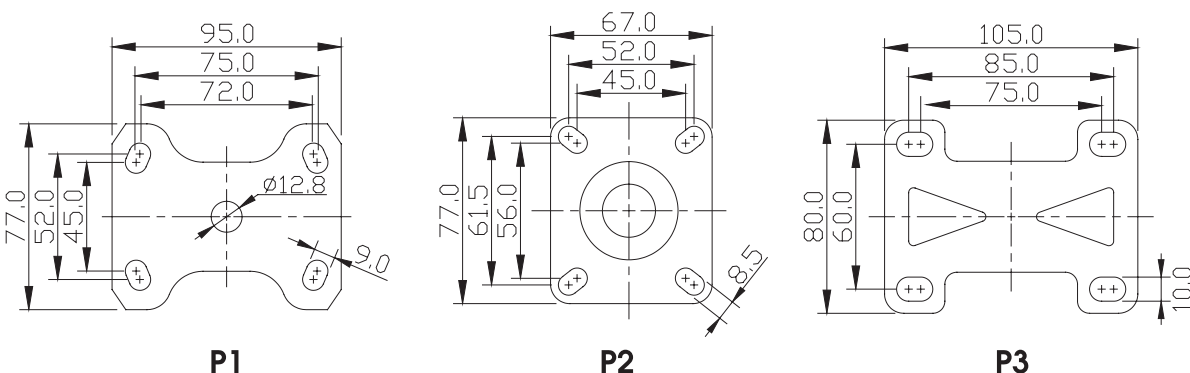

# 2C-PSS Polished Stainless Steel

## GRIP RING STEM OPTIONS (GR)

Stem Code	Stem Dimensions
GR1	3/4" diameter x 2-3/16" long
GR2	13/16" diameter x 2-3/16" long
GR3	.845" diameter x 2-3/16" long
GR4	.865" diameter x 2-3/16" long
GR5	1" diameter x 2-3/16" long
GR6	.860" square x 2-3/16" long

## THREADED STEM OPTIONS (TS)

Stem Code	Stem Dimensions
TS1	1/2" diameter –13 x 3/4" long
TS2	1/2" diameter –13 x 1" long
TS3	1/2" diameter –13 x 1-1/2" long
TS4	1/2" diameter –20 x 3/4" long
TS5	1/2" diameter –20 x 2-1/4" long
TS6	5/8" diameter –11 x 1-1/4" long
TS7	5/8" diameter – 18 x 1-3/4" long
TS8	3/4" diameter – 10 x 1" long

OTHER SPECIAL STEMS AVAILABLE, STANDARD OR STAINLESS STEEL.

## EXPANDING ADAPTER STEMS (ES)

Adapter #	Tubing ID	Adapter #	Tubing ID
ES9	3/4"	ES17B	1-3/16"
ES11	7/8"	ES19C	1-3/8"
ES13	1"	ES19A	1-1/2"
ES15	1-1/8"	ES21	1-7/8"

Rubber bushing expands inside of tubing as 3/4" nut beneath lower raceway is turned with wrench. Plastic bushing on bottom of stem provides stability for stem inside of tubing for tight, permanent fit. Threaded stem size (less adapter): 1/2" dia. x 2-3/4" long. To order, add adapter number to end of model #.



Hole Type

## 2C-PSS HOLLOW KINGPIN (H3)

Mounting Options: H3

Diameter: 12.8 mm.

Bolt Size: 1/2"

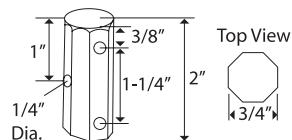







## 2C-PSS OCTAGON STEM (OC)

Standard Octagon Stem Size: OC

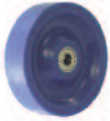
3/4" octagon 2" long with 3 cross-drilled mounting holes.

# 2C-PSS Polished Stainless Steel - Plate Type

## 2C-PSS CASTER SPECIFICATIONS (PLATE TYPE)

Wheel Type (Wheel Code)	Diameter (in.)	Width (mm.)	Capacity (lbs.)	OAH (mm.)	Swivel Lead (mm.)	Swivel Part Number **
<b>KRYPTONIC™ (KR) WHEELS WITH STAINLESS STEEL PRECISION BALL BEARINGS</b>						
	3	30	130	107	33	2C-PSS-P1-KR-P-0330-S
	4	30	175	135	40.5	2C-PSS-P1-KR-P-04030-S
	5	30	220	161	39	2C-PSS-P1-KR-P-05030-S
<b>THERMOPLASTIC URETHANE / NYLON CORE (TUN) OR POLYOLEFIN CORE (TUB) WHEELS WITH STAINLESS STEEL PRECISION BALL BEARINGS</b>						
	3	32	110	107	33	2C-PSS-P1-TUN-P-0332-S
	4	32	175	135	40.5	2C-PSS-P1-TUB-P-0432-S
	5	32	220	161	39.5	2C-PSS-P1-TUB-P-0532-S
	6	32	240	189.5	50	2C-PSS-P1-TUB-P-0632-S
<b>URETHANE TREAD / NYLON CORE (UR/NN) WHEELS WITH STAINLESS STEEL PRECISION BALL BEARINGS</b>						
	3	25	130	107	33	2C-PSS-P1-UR/NN-P-0325-S
	4	28	220	135	40.5	2C-PSS-P1-UR/NN-P-0428-S
	5	28	275	161	39	2C-PSS-P1-UR/NN-P-0528-S
<b>ELASTIC RUBBER / PRESSED STEEL HUB (ER/STL) WHEELS WITH METAL THREAD GARDS / STAINLESS STEEL PRECISION BALL BEARINGS</b>						
	4	32	175	135	40.5	2C-PSS-P1-ER/STL-P-0432-S
	5	32	220	161	39	2C-PSS-P1-ER/STL-P-0532-S
	6	32	245	167	45	2C-PSS-P1-ER/STL-P-0632-S
<b>THERMOPLASTIC RUBBER / POLYOLEFIN CORE (TPR) WHEELS WITH PLASTIC THREAD GARDS / STAINLESS STEEL PRECISION BALL BEARINGS</b>						
	3	30	130	107	33	2C-PSS-P1-TPR-P-0430-S
	4	30	175	135	40.5	2C-PSS-P1-TPR-P-0430-S
	5	30	220	161	39	2C-PSS-P1-TPR-P-0530-S
	6	30	245	167	45	2C-PSS-P1-TPR-P-0630-S
<b>ADVANCED GREY RUBBER / POLYOLEFIN CORE / DONUT TREAD (AR/PO/DT) WHEELS WITH STAINLESS STEEL PRECISION BALL BEARINGS</b>						
	3	32	130	107	33	2C-PSS-P1-AR/PO/DT-P-0432-S
	4	32	175	135	40.5	2C-PSS-P1-AR/PO/DT-P-0432-S
	5	32	220	161	39	2C-PSS-P1-AR/PO/DT-P-0532-S
	6	32	245	167	45	2C-PSS-P1-AR/PO/DT-P-0632-S
<b>WHITE POLYOLEFIN (PW) WHEELS WITH STAINLESS STEEL PRECISION BALL BEARINGS</b>						
	3	32	130	107	33	2C-PSS-P1-PW-P-0432-S
	4	32	175	135	40.5	2C-PSS-P1-PW-P-0432-S
	5	32	220	161	39	2C-PSS-P1-PW-P-0532-S
	6	32	245	167	45	2C-PSS-P1-PW-P-0632-S







## WHEEL TYPES

All wheels are available with Stainless Steel Precision Ball Bearings, Stainless Steel Roller Bearings and Delrin Bushings with SS Spanners.

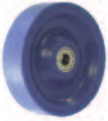
- Advantage TPR Round (AR)
- Advantage TPR Flat (AF)
- Advantage Heat Round (AHR)
- Advantage Heat Flat (AHF)
- Advantage Health Antimicrobial (PREV)
- Heateater, Hi-Temp Nylon (HE)
- Hi-Temp Resin (NHT)
- Kryptonite™, Blue (KR)
- Kryptonite™, Gray (KRG)
- Kryptonite™, Black (KRB)
- Nylacron™ (NY/MD)
- Nylacron™ Monocast (NY/MC)
- Nylon, White (NN)
- Polyurethane Welded Disc, Blue (PWDB)
- Polyolefin, Black (PB)
- Polyolefin, White (PW)
- Phenolic (TM)
- Phenolic, High Temp (TR)
- PolyLoc, Blue (PLB)
- PolyLoc, Gray (PLG)
- Retort (RT)
- Rubber, Conductive (CSR)
- Rubber, Cushion (CR)
- Rubber, Hard (HR)
- Rubber, Soft (SR)
- Rubber, Extra Soft Flat Tread (XSF)
- Rubber, Extra Soft Round Tread (XSR)
- Urethane on Nylon (URN)

# 2C-PSS Polished Stainless Steel - Stem Type

## 2C-PSS CASTER SPECIFICATIONS (STEM TYPE)

Wheel Type (Wheel Code)	Diameter (in.)	Width (mm.)	Capacity (lbs.)	OAH (mm.)	Swivel Lead (mm.)	Swivel Part Number **
<b>KRYPTONIC™ (KR) WHEELS WITH STAINLESS STEEL PRECISION BALL BEARINGS</b>						
	3	30	130	107	33	2C-PSS-TS1-KR-P-0330-S
	4	30	175	135	40.5	2C-PSS-TS1-KR-P-04030-S
	5	30	220	161	39	2C-PSS-TS1-KR-P-05030-S
<b>THERMOPLASTIC URETHANE / NYLON CORE (TUN) OR POLYOLEFIN CORE (TUB) WHEELS WITH STAINLESS STEEL PRECISION BALL BEARINGS</b>						
	3	32	110	107	33	2C-PSS-TS1-TUN-P-0332-S
	4	32	175	135	40.5	2C-PSS-TS1-TUB-P-0432-S
	5	32	220	161	39.5	2C-PSS-TS1-TUB-P-0532-S
	6	32	240	189.5	50	2C-PSS-TS1-TUB-P-0632-S
<b>URETHANE TREAD / NYLON CORE (UR/NN) WHEELS WITH STAINLESS STEEL PRECISION BALL BEARINGS</b>						
	3	25	130	107	33	2C-PSS-TS1-UR/NN-P-0325-S
	4	28	220	135	40.5	2C-PSS-TS1-UR/NN-P-0428-S
	5	28	275	161	39	2C-PSS-TS1-UR/NN-P-0528-S
<b>ELASTIC RUBBER / PRESSED STEEL HUB (ER/STL) WHEELS WITH METAL THREAD GARDS / STAINLESS STEEL PRECISION BALL BEARINGS</b>						
	4	32	175	135	40.5	2C-PSS-TS1-ER/STL-P-0432-S
	5	32	220	161	39	2C-PSS-TS1-ER/STL-P-0532-S
	6	32	245	167	45	2C-PSS-TS1-ER/STL-P-0632-S
<b>THERMOPLASTIC RUBBER / POLYOLEFIN CORE (TPR) WHEELS WITH PLASTIC THREAD GARDS / STAINLESS STEEL PRECISION BALL BEARINGS</b>						
	3	30	130	107	33	2C-PSS-TS1-TPR-P-0430-S
	4	30	175	135	40.5	2C-PSS-TS1-TPR-P-0430-S
	5	30	220	161	39	2C-PSS-TS1-TPR-P-0530-S
	6	30	245	167	45	2C-PSS-TS1-TPR-P-0630-S
<b>ADVANCED GREY RUBBER / POLYOLEFIN CORE / DONUT TREAD (AR/PO/DT) WHEELS WITH STAINLESS STEEL PRECISION BALL BEARINGS</b>						
	3	32	130	107	33	2C-PSS-TS1-AR/PO/DT-P-0432-S
	4	32	175	135	40.5	2C-PSS-TS1-AR/PO/DT-P-0432-S
	5	32	220	161	39	2C-PSS-TS1-AR/PO/DT-P-0532-S
	6	32	245	167	45	2C-PSS-TS1-AR/PO/DT-P-0632-S
<b>WHITE POLYOLEFIN (PW) WHEELS WITH STAINLESS STEEL PRECISION BALL BEARINGS</b>						
	3	32	130	107	33	2C-PSS-TS1-PW-P-0432-S
	4	32	175	135	40.5	2C-PSS-TS1-PW-P-0432-S
	5	32	220	161	39	2C-PSS-TS1-PW-P-0532-S
	6	32	245	167	45	2C-PSS-TS1-PW-P-0632-S







## WHEEL TYPES

All wheels are available with Stainless Steel Precision Ball Bearings, Stainless Steel Roller Bearings and Delrin Bushings with SS Spanners.

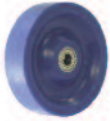
- Advantage TPR Round (AR)
- Advantage TPR Flat (AF)
- Advantage Heat Round (AHR)
- Advantage Heat Flat (AHF)
- Advantage Health Antimicrobial (PREV)
- Heateater, Hi-Temp Nylon (HE)
- Hi-Temp Resin (NHT)
- Kryptonics™, Blue (KR)
- Kryptonics™, Gray (KRG)
- Kryptonics™, Black (KRB)
- Nylacron™ (NY/MD)
- Nylacron™ Monocast (NY/MC)
- Nylon, White (NN)
- Polyurethane Welded Disc, Blue (PWDB)
- Polyolefin, Black (PB)
- Polyolefin, White (PW)
- Phenolic (TM)
- Phenolic, High Temp (TR)
- PolyLoc, Blue (PLB)
- PolyLoc, Gray (PLG)
- Retort (RT)
- Rubber, Conductive (CSR)
- Rubber, Cushion (CR)
- Rubber, Hard (HR)
- Rubber, Soft (SR)
- Rubber, Extra Soft Flat Tread (XSF)
- Rubber, Extra Soft Round Tread (XSR)
- Urethane on Nylon (URN)

# 2C-PSS Polished Stainless Steel - Hole Type H3

## 2C-PSS CASTER SPECIFICATIONS (HOLE TYPE H3)

Wheel Type (Wheel Code)	Diameter (in.)	Width (mm.)	Capacity (lbs.)	OAH (mm.)	Swivel Lead (mm.)	Swivel Part Number **
<b>KRYPTONIC™ (KR) WHEELS WITH STAINLESS STEEL PRECISION BALL BEARINGS</b>						
	3	30	130	107	33	2C-PSS-H3-KR-P-0330-S
	4	30	175	135	40.5	2C-PSS-H3-KR-P-04030-S
	5	30	220	161	39	2C-PSS-H3-KR-P-05030-S
<b>THERMOPLASTIC URETHANE / NYLON CORE (TUN) OR POLYOLEFIN CORE (TUB) WHEELS WITH STAINLESS STEEL PRECISION BALL BEARINGS</b>						
	3	32	110	107	33	2C-PSS-H3-TUN-P-0332-S
	4	32	175	135	40.5	2C-PSS-H3-TUB-P-0432-S
	5	32	220	161	39.5	2C-PSS-H3-TUB-P-0532-S
	6	32	240	189.5	50	2C-PSS-H3-TUB-P-0632-S
<b>URETHANE TREAD / NYLON CORE (UR/NN) WHEELS WITH STAINLESS STEEL PRECISION BALL BEARINGS</b>						
	3	25	130	107	33	2C-PSS-H3-UR/NN-P-0325-S
	4	28	220	135	40.5	2C-PSS-H3-UR/NN-P-0428-S
	5	28	275	161	39	2C-PSS-H3-UR/NN-P-0528-S
<b>ELASTIC RUBBER / PRESSED STEEL HUB (ER/STL) WHEELS WITH METAL THREAD GARDS / STAINLESS STEEL PRECISION BALL BEARINGS</b>						
	4	32	175	135	40.5	2C-PSS-H3-ER/STL-P-0432-S
	5	32	220	161	39	2C-PSS-H3-ER/STL-P-0532-S
	6	32	245	167	45	2C-PSS-H3-ER/STL-P-0632-S
<b>THERMOPLASTIC RUBBER / POLYOLEFIN CORE (TPR) WHEELS WITH PLASTIC THREAD GARDS / STAINLESS STEEL PRECISION BALL BEARINGS</b>						
	3	30	130	107	33	2C-PSS-H3-TPR-P-0430-S
	4	30	175	135	40.5	2C-PSS-H3-TPR-P-0430-S
	5	30	220	161	39	2C-PSS-H3-TPR-P-0530-S
	6	30	245	167	45	2C-PSS-H3-TPR-P-0630-S
<b>ADVANCED GREY RUBBER / POLYOLEFIN CORE / DONUT TREAD (AR/PO/DT) WHEELS WITH STAINLESS STEEL PRECISION BALL BEARINGS</b>						
	3	32	130	107	33	2C-PSS-H3-AR/PO/DT-P-0432-S
	4	32	175	135	40.5	2C-PSS-H3-AR/PO/DT-P-0432-S
	5	32	220	161	39	2C-PSS-H3-AR/PO/DT-P-0532-S
	6	32	245	167	45	2C-PSS-H3-AR/PO/DT-P-0632-S
<b>WHITE POLYOLEFIN (PW) WHEELS WITH STAINLESS STEEL PRECISION BALL BEARINGS</b>						
	3	32	130	107	33	2C-PSS-H3-PW-P-0432-S
	4	32	175	135	40.5	2C-PSS-H3-PW-P-0432-S
	5	32	220	161	39	2C-PSS-H3-PW-P-0532-S
	6	32	245	167	45	2C-PSS-H3-PW-P-0632-S

## WHEEL TYPES

All wheels are available with Stainless Steel Precision Ball Bearings, Stainless Steel Roller Bearings and Delrin Bushings with SS Spanners.

- Advantage TPR Round (AR)
- Advantage TPR Flat (AF)
- Advantage Heat Round (AHR)
- Advantage Heat Flat (AHF)
- Advantage Health Antimicrobial (PREV)
- Heateater, Hi-Temp Nylon (HE)
- Hi-Temp Resin (NHT)
- Kryptonite™, Blue (KR)
- Kryptonite™, Gray (KRG)
- Kryptonite™, Black (KRB)
- Nylacron™ (NY/MD)
- Nylacron™ Monocast (NY/MC)
- Nylon, White (NN)
- Polyurethane Welded Disc, Blue (PWDB)
- Polyolefin, Black (PB)
- Polyolefin, White (PW)
- Phenolic (TM)
- Phenolic, High Temp (TR)
- PolyLoc, Blue (PLB)
- PolyLoc, Gray (PLG)
- Retort (RT)
- Rubber, Conductive (CSR)
- Rubber, Cushion (CR)
- Rubber, Hard (HR)
- Rubber, Soft (SR)
- Rubber, Extra Soft Flat Tread (XSF)
- Rubber, Extra Soft Round Tread (XSR)
- Urethane on Nylon (URN)