

**Caster Type****Page**

610 Kingpinless Casters.....2-5

615 Dual Wheel Kingpinless Casters.....6-7

S610 Spring Loaded Casters.....8-9

ALL WHEELS ARE AVAILABLE WITH  
PRECISION BALL BEARING, CENTERPIECE & END CAPS  
FOR MANUAL OR TOWING TO FIT IN 3-1/2" HUB LENGTH RIGS.  
See Wheel Section for complete selection.

# 8 610 KINGPINLESS CASTERS



## 7,200 LBS. LOAD CAPACITY KINGPINLESS TYPE CASTERS

- **Top Plate:** 1/2" thick AISI 1045 steel precision machined and through-hardened for longer life.
- **Swivel Section:** 3/4" ball bearings mounted in a 4-3/8" precision machined raceway Zerk in swivel section.
- **Legs:** 3/8" thick steel welded to yoke base using 100,000 psi weld filler.
- **Axle:** 2-1/2" and 3" tread width wheels feature a 3/4" axle, 3-1/2" and 4" tread width wheels feature a 1" axle.
- Alternate or custom caster configurations available.

### BRAKE OPTIONS



**Poly Cam**  
specify **P**



**Single Sided** specify **SSB610**  
**Double Sided** specify **DSB610**



**Face Contact**  
specify **F**



**Hand Operated Swivel Lock**  
specify **SL6000000**



**TOE GUARDS AVAILABLE TO**

### MOUNTING OPTION

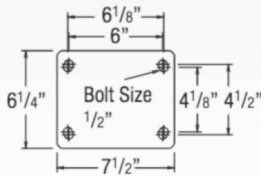

### SWIVEL CROSS SECTION



*Highly recommended for automotive and aerospace applications. This caster is built to take the punishment of constant swiveling or for service where shock or impact loads might damage less rugged casters.*

### TYPICAL APPLICATIONS

- Body dolly carts
- Engine dollies
- Material carts
- Chassis rack carts
- Paint line dollies
- Towed trash gondolas

### TOP PLATE: (STANDARD)

- Plate Size:** 6-1/4" x 7-1/2"
- Bolt Holes:** 6-1/8" x 4-1/2" slotted to 6" x 4-1/8"
- Bolt Size:** 1/2"

# 8 610 KINGPINLESS CASTERS

## NYLACRON™ WHEELS PRECISION BALL BEARINGS NY/MD

- Precision Machined from Cast Polyamide. Hardness 112-120 Rockwell R.
- Ultimate choice for Extremely High Load applications to replace metallic wheels.
- Offer very high abrasion resistance and very low rolling resistance under extreme loads.

- Resistant to salt, grease, alcohol and mild acids - can be used in corrosive applications with appropriate bearings.
- Large Precision Ball Bearings.
- Temperature Range: -40°F to +270°F.

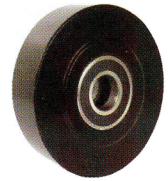

Part Number Swivel Caster	Part Number Rigid Caster	Wheel Diameter (inch)	Tread Width (inch)	Load Capacity (lbs)	Overall Height (inch)	Swivel Lead (inch)S
610S63NYMD	610R63NYMD	6	3	7200	8	2-7/32
610S83NYMD	610R83NYMD	8	3	7200	10-1/2	2-15/16
610S103NYMD	610R103NYMD	10	3	7200	12-1/2	3-3/8
610S123NYMD	610R123NYMD	12	3	7200	12-1/2	3-3/8

## POLYURETHANE ON CAST IRON ROLLER BEARING PY

- Tapered (09)

- Straight Roller Bearing (01)



Part Number Swivel Caster	Part Number Rigid Caster	Wheel Diameter (inch)	Tread Width (inch)	Load Capacity (lbs)	Overall Height (inch)	Swivel Lead (inch)
610PY06509	610PX06509R	6	3	2040	8-1/2	1-3/4
610PY08509	610PX08509R	8	3	2520	10-1/2	2-1/4
610PY08709	610PX08709R	8	4	3500	10-1/2	2-1/4
610PY10509	610PX10509R	10	3	3000	12-1/2	2-3/4
610PY10709	610PX10709R	10	4	4200	12-1/2	2-3/4
610PY12709	610PX12709R	12	4	4800	15-1/2	3-5/8
610PY14709	610PX14709R	14	4	5000	18	4-3/8

## THICK TREAD POLYURETHANE ROLLER BEARING PX

- Tapered (09)

- Straight Roller Bearing (01)



Part Number Swivel Caster	Part Number Rigid Caster	Wheel Diameter (inch)	Tread Width (inch)	Load Capacity (lbs)	Overall Height (inch)	Swivel Lead (inch)
610PX06509	610PX06509R	6	3	2040	8-1/2	1-3/4
610PX08509	610PX08509R	8	3	2520	10-1/2	1-3/4
610PX08709	610PX08709R	8	4	3500	10-1/2	2-1/4
610PX10509	610PX10509R	10	3	3000	12-1/2	2-3/4
610PX10709	610PX10709R	10	4	4200	12-1/2	2-3/4
610PX12709	610PX12709R	12	4	4800	15-1/2	3-5/8

# 8 610 KINGPINLESS CASTERS

## VULKOLLAN™ THICK TREAD POLYURETHANE ROLLER BEARING VX

- Tapered (09)
- Precision Ball Bearings (28).
- Straight Roller Bearing (01).

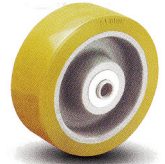

Part Number Swivel Caster	Part Number Rigid Caster	Wheel Diameter (inch)	Tread Width (inch)	Load Capacity (lbs)	Overall Height (inch)	Swivel Lead (inch)
610VX06509	610VX06509R	6	3	3000	8-1/2	1-3/4
610VX08509	610VX08509R	8	3	4000	10-1/2	2-1/4
610VX10509	610VX10509R	10	3	5000	12-1/2	2-3/4

## POLYURETHANE ON HEAVY DUTY CAST IRON PF

- Precision Ball Bearings (28).
- Tapered (09)
- Straight Roller Bearing (01).



Part Number Swivel Caster	Part Number Rigid Caster	Wheel Diameter (inch)	Tread Width (inch)	Load Capacity (lbs)	Overall Height (inch)	Swivel Lead (inch)
610PF08528	610PF08528R	8	3	4000	10-1/2	2-1/4
610PF10528	610PF10528R	10	3	4200	12-1/2	2-3/4
610PF12528	610PF12528R	12	3	4400	15-1/2	2-3/4

## HEAVY DUTY LARGE BORE DROP FORGED STEEL TAPERED BEARING FH

- Straight Roller Bearing (01).
- Tapered (09)



Part Number Swivel Caster	Part Number Rigid Caster	Wheel Diameter (inch)	Tread Width (inch)	Load Capacity (lbs)	Overall Height (inch)	Swivel Lead (inch)
610FH08501	610FH08501R	8	3	6000	10-1/2	2-1/4
610FH10501	610FH10501R	10	3	6000	12-1/2	2-3/4

SEE WHEEL SECTION FOR OTHER WHEELS AVAILABLE



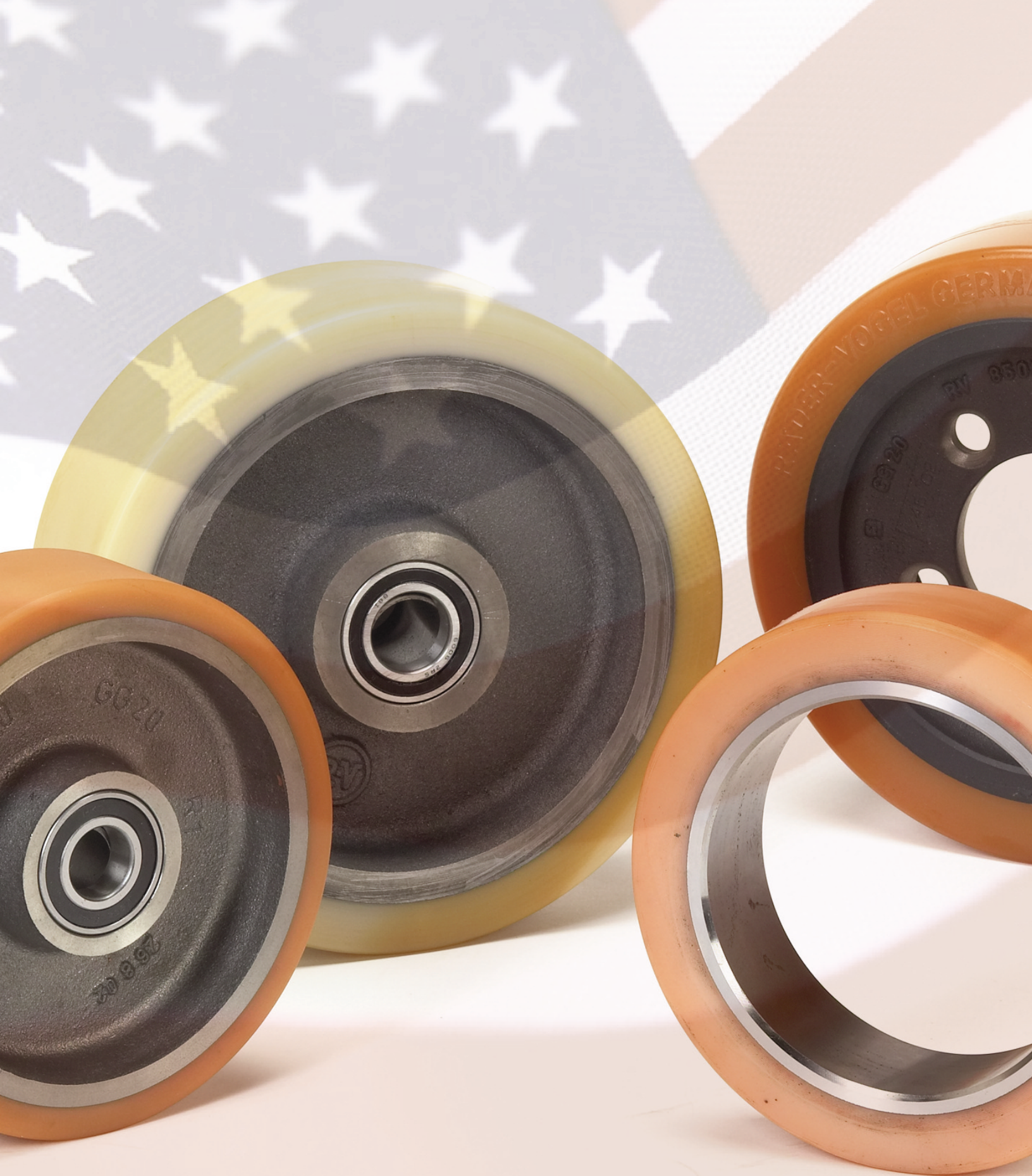

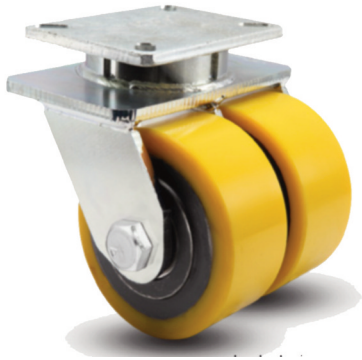

## 10,000 LBS. LOAD CAPACITY KINGPINLESS TYPE CASTERS

- **Raceway Design:** Kingpinless single ball bearing precision machined raceway hardened to 53 Rockwell C minimum. Swivel section features a 3" diameter raceway with 1/2" ball bearings. The notched yoke is standard.
- **Finish:** Laguna Blue paint.
- **Yoke Base:** Harden C1040 steel.
- **Legs:** 3/8" formed steel. Center leg support is added for increased strength.
- **Wheels:** All wheels are 3" and 4" wide with precision bearings for minimal maintenance.
- **Axle:** 3/4" bolt, locking nut and lubrication fittings.
- Alternate or custom caster configurations available.

### BRAKE OPTIONS

**CWB** Cam Wheel Brake

### SWIVEL RIG OPTIONS

**HT** High Temperature Lubrication

**LT** Low Temperature Lubrication

**DSL** Demountable Swivel Lock

**SL** Swivel Lock

**SR** Sealed Swivel Raceway

**TG** Thread Guard

To order a rigid caster, change the "S" to "R" in the model number. Dimensions shown are nominal. If precise dimensions are required, consult Acorn™. For approximate weight of our rigid casters, deduct 3.9 pounds.

### 615 MOUNTING OPTION

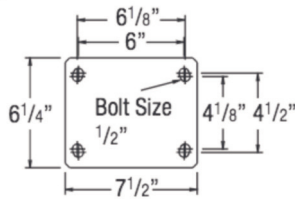

### TOP PLATE: (STANDARD)

**Plate Size:** 6-1/4" x 7-1/2"

**Bolt Holes:** 4-1/2" x 6"  
slotted to  
4-1/8" x 6-1/8"

**Bolt Size:** 1/2"

### 615 SWIVEL CROSS SECTION

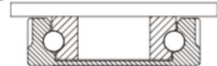

**NYLACRON™ WHEELS  
PRECISION BALL BEARINGS  
NY/MD**

- Precision Machined from Cast Polyamide. Hardness 112-120 Rockwell R.
- Ultimate choice for Extremely High Load applications to replace metallic wheels.
- Offer very high abrasion resistance and very low rolling resistance under extreme loads.
- Resistant to salt, grease, alcohol and mild acids - can be used in corrosive applications with appropriate bearings.
- Large Precision Ball Bearings.
- Temperature Range: -40°F to +270°F.

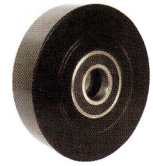

Part Number Swivel Caster	Part Number Rigid Caster	Wheel Diameter (inch)	Tread Width (inch)	Load Capacity (lbs)	Overall Height (inch)	Swivel Part Number Add B, P, PL, R or T*	
						Swivel Lead (inch)	Wt. (lbs.)
615S63NYMD	615R63NYMD	6	3	10,000	8-1/2	1-9/16	30
615S83NYMD	615R83NYMD	8	3	10,000	10-1/2	2	33
615S1030NYMD	615R1030NYMD	10	3	10,000	12-1/2	2	38
615S1230NYMD	615R1230NYMD	12	3	10,000	15-1/2	2-1/2	40
615S84NYMD	615R84NYMD	8	4	10,000	12-1/2	4-1/8	40
615S1040NYMD	615R1040NYMD	10	4	10,000	12-1/2	2-1/2	42
615S1020NYMD	615R1020NYMD	12	4	10,000	15-1/2	3-3/8	50
615S1440NYMD	615R1440NYMD	14	4	10,000	16-1/2	3-13/16	54
615S164063NYMD	615R164063NYMD	16	4	10,000	18-1/2	4	68



### Nylacron™ Wheels

With Precision Ball Bearings for Any Application  
(also available in black, blue, white & red)

Nylacron™ wheels with proper sized precision bearings are made to fit in any rig hub length and axle size. Nylacron™ wheels have greater load capacity ratings with better rollability while requiring less maintenance and have longer life.

**SEE NYLACRON™ WHEEL SECTION  
FOR CUSTOM SIZES & SHAPES**



# 8 S610 SPRING LOADED CASTERS

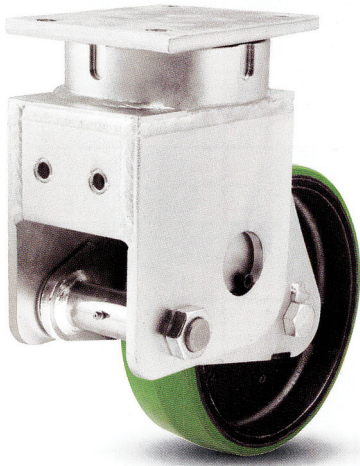

## 3,000 LBS. LOAD CAPACITY KINGPINLESS TYPE CASTERS

- **Load Springs:** Different load springs for each series permits wide variation in ride “softness”.
- **Complete Line:** Available on all 8KSL models.
- **Swivel Section:** Kingpinless design. Ball bearing mounted in a machined raceway.
- **Axle:** 3/4” diameter standard. Optional 1” diameter available.
- Alternate or custom caster configurations available.

*Our newly designed spring loaded casters offer greater capacity and protection from damaging shock or unwanted vibration and movement. Noise levels are reduced through the dampening effect of these casters.*

*We offer many custom spring loaded solutions for the automotive and aviation industry.*

### TYPICAL APPLICATIONS

- Body dolly carts
- Engine dollies
- Material carts
- Chassis rack carts
- Paint line dollies
- Towed trash gondolas
- Aviation ground support
- Aircraft tripod jacks
- Shock sensitive loads

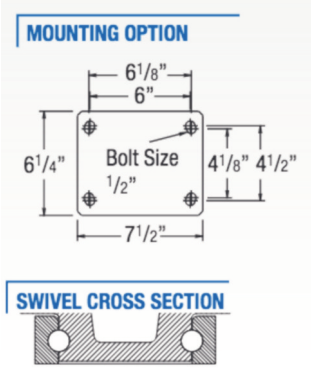

### TOP PLATE: (STANDARD)

- Plate Size:** 6-1/4” x 7-1/2”
- Bolt Holes:** 4-1/2” x 6-1/8”  
slotted to  
4-1/8” x 6-1/2”
- Bolt Size:** 1/2”



# 8 S610 SPRING LOADED CASTERS

## NYLACRON™ WHEELS PRECISION BALL BEARINGS NY/MD

Part Number Swivel Caster	Part Number Rigid Caster	Wheel Diameter (inch)	Tread Width (inch)	Load Capacity (lbs)	Overall Height (inch)	Swivel Lead (inch)
S610S63NYMD	S610R63NYMD	6	3	3000	7-1/2	1-3/8
S610S83NYMD	S610R83NYMD	8	3	3000	10-1/8	2-1/16
S610S103NYMD	S610R103NYMD	10	3	3000	11-1/2	2-1/4
S610S123NYMD	S610R123NYMD	12	3	3000	13-1/2	2-11/16

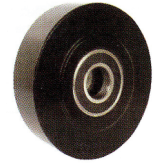

## POLYURETHANE TREAD ON CAST IRON PRECISION BALL BEARINGS PF

Part Number Swivel Caster	Part Number Rigid Caster	Wheel Diameter (inch)	Tread Width (inch)	Load Capacity (lbs)	Overall Height (inch)	Swivel Lead (inch)
S610S63PF	S610R63PF	6	3	3000	11-3/4	4-1/2
S610S83PF	S610R83PF	8	3	3000	12-3/4	4-1/2
S610S103PF	S610R103PF	10	3	3000	14-7/8	4-1/2
S610S123PF	S610R123PF	12	3	3000	16-7/8	5-5/16



## VULKOLLAN™ THICK TREAD POLYURETHANE ROLLER BEARING VX

• Tapered (09)

• Precision Ball Bearings (28).  
• Straight Roller Bearing (01)

Part Number Swivel Caster	Part Number Rigid Caster	Wheel Diameter (inch)	Tread Width (inch)	Load Capacity (lbs)	Overall Height (inch)	Swivel Lead (inch)
S610VX08509	S610VX08509R	8	3	3000	12-3/4	4-1/2
S610VX10509	S610VX10509R	10	3	3000	14-7/8	4-1/2

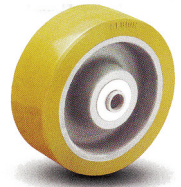

## POLYURETHANE TREAD ON CAST IRON PRECISION BALL BEARINGS PR

• Precision Ball Bearings (28)

• Tapered (09)

Part Number Swivel Caster	Part Number Rigid Caster	Wheel Diameter (inch)	Tread Width (inch)	Load Capacity (lbs)	Overall Height (inch)	Swivel Lead (inch)
S610PR10528	S610PR10528R	10	3	2400	14-7/8	4-1/2
S610PR12528	S610PR12528R	12	3	2800	16-7/8	5-5/16



## SWIVEL-EAZ™ 95A CROWN TREAD PRECISION BALL BEARINGS SWE/CT

• Crown tread also available in 70A, 80A, 60D & 75D durometer

• Available in Flat Tread add FT

Part Number Swivel Caster	Part Number Rigid Caster	Wheel Diameter (inch)	Tread Width (inch)	Load Capacity (lbs)	Overall Height (inch)	Swivel Lead (inch)
S610S63SWECT	S610R63SWECT	6	3	1100	11-3/4	4-1/2
S610S83SWECT	S610R83SWECT	8	3	2400	12-3/4	4-1/2
S610S103SWECT	S610R103SWECT	10	3	3000	14-7/8	4-1/2

