

1 LIGHT DUTY CASTERS



Caster Type	Page
1T General Duty Casters	2-3
1D Light Duty Casters with TPR wheels	4
1B Light Duty Dual Wheel Casters with TPR wheels.....	5
1DW Dual Wheel Casters	6-7
1V Glass Handling Casters.....	8-10
1N Light Duty Urethane.....	11
1RTWK Light Duty Stainless Steel TPR.....	12

1 1T GENERAL DUTY CASTERS



Swivel

A sturdy light-duty caster. The single ball race design makes the 01 series an economical, yet dependable caster.

Typical Applications:

- Moving Dollies
- Institutional equipment
- Furniture
- Display & Merchandise Racks

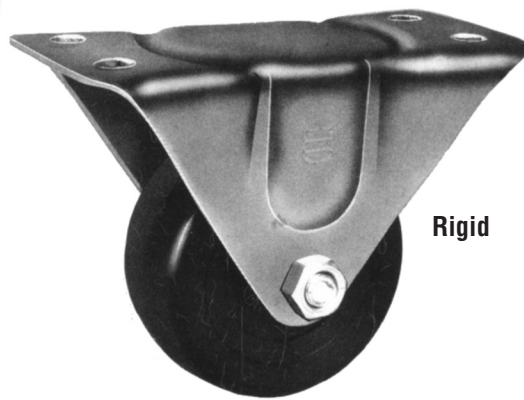

Rigid

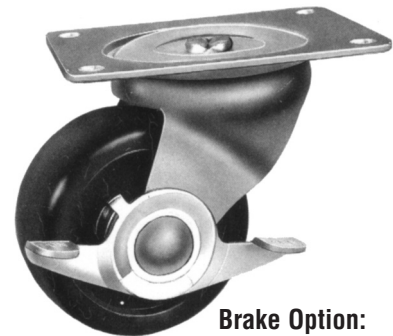

Brake Option:
Add **B** to part number
for cam brake (swivel only)

300 LBS. LOAD CAPACITY TYPE CASTERS

- Top Plate & Yoke: Heavily embossed, formed steel for strength and durability
- Swivel Section: Single ball raceway for free swiveling under load.
- Finish: All parts, except wheel, are zinc plated to prevent rust or resist corrosion.
- Alternate or custom cast configurations available.

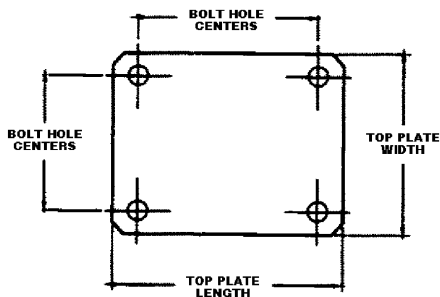

Swivel

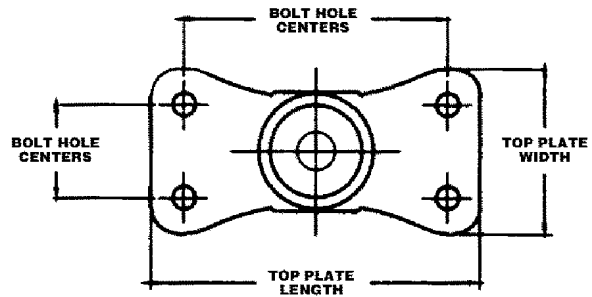

Rigid

CASTER SPECIFICATIONS

Wheel Type (Wheel Code)	Wheel Diameter (inch)	Tread Width (inch)	Bearing Type	Load Capacity (lbs)	Overall Height (inch)	Swivel Lead (inch)	Swivel Part Number Rigid add R*
STEEL (STL) WHEELS WITH PLAIN BEARINGS	2	15/16	Plain	125	2-7/16	1-3/4	1TSTL2S
	2-1/2	1-1/16	Plain	200	3-1/4	2-3/8	1TSTL25S
	3	1-1/4	Plain	250	3-3/4	2-7/16	1TSTL3S
	4	1-1/4	Plain	300	5	2-9/32	1TSTL4S
HEAVY DUTY PLASTIC (HDP) WHEELS WITH PLAIN BEARINGS	3	1-1/4	Plain	250	3-3/4	2-7/16	1THDP3S
	4	1-1/4	Plain	300	5	2-9/32	1THDP4S
POLYURETHANE (PLY) WHEELS WITH PLAIN BEARINGS	2	15/16	Plain	90	2-7/16	1-3/4	1TPLY2S
	2-1/2	1-1/16	Plain	100	3-1/4	2-3/8	1TPLY25S
	3	1-1/4	Plain	140	3-3/4	2-7/16	1TPLY3S
	3	1-1/4	Plain	220	3-3/4	2-7/16	1TPLY4S
HARD RUBBER (HR) WHEELS WITH NYLON BEARINGS	3	1-1/4	Nylon	225	3-3/4	2-7/16	1THR3S
	4	1-1/4	Nylon	250	5	2-9/32	1THR4S
SOFT RUBBER (SR) WHEELS WITH NYLON BEARINGS	3	1-1/4	Nylon	175	3-3/4	2-7/16	1TSR3S
	4	1-1/4	Nylon	255	5	2-9/32	1TSR4S

MOUNTING PLATE DIMENSIONS

Wheel Dia. (inch)	Plate Dimensions (inch)	Bolt Spacing (inch)	Bolt Size (inch)
Swivel			
2	1-7/8 x 2-9/16	15/16 x 2-1/8	1/4
2-1/2	2-3/4 x 3-7/8	1-3/4 x 3	5/16
3	3-1/8 x 4-1/8	2-3/8 x 3-3/8 to 3-7/16	5/16
4	4 x 5-1/8	3 x 4	3/8
Rigid			
2	1-1/2 x 2-21/32	15/16 x 2-1/8	1/4
2-1/2	2-1/8 x 4-3/8	1-1/16 x 3-1/2	5/16
3	2-5/16 x 4-7/8	1-3/16 x 4	5/16
4	3-1/16 x 6-1/8	1-3/4 x 5	3/8

1

1D LIGHT DUTY CASTERS **Neoprene Rubber Wheels**



**Stem Caster with
BLACK SOFT NEOPRENE
RUBBER WHEELS
Precision Ball Bearings
Stem 70A shown**

OTHER STEMS AVAILABLE

Size	Stem Type	Stem
11mm I.D.	Hollow Kingpin	23
3/8-16 x 1-1/2	Thread Stem	33
7/16 x 1	Grip Ring Stem	70
7/16 x 7/8	Grip Ring Stem	70A
7/16 x 1-3/8	Grip Ring Stem	72

110 LBS. LOAD CAPACITY TYPE CASTERS

- Full heat treated raceway to enhance durability.
- Wheels with precision bearings.
- Brake option available.
- 3/8" ID hollow kingpin.
- Offered in polished chrome or polished black chrome finish.
- Caster yoke and swivel raceway are hardened for durability and long life.
- Standard 7/16 x 7/8 grip ring stem.

Premium chair caster series is your best choice for ergonomic mobility and floor protection on your office chair, furniture and other equipment that may roll on both hard floors (cement, hard wood, tile, etc.) and soft floor surfaces (carpets, mats, etc.)

Applications

- Office chairs
- Furniture
- Medical & institutional stands and equipment
- Diagnostic & electrical equipment

CASTER SPECIFICATIONS

Wheel Diameter	Tread Width	Wheel Type	Load Capacity	Finish Type	Bearing Type	Swivel Caster Part Number	Overall Height	Swivel Radius	Fastener Spec.
2	13/16	Black PolyFlexon® Dual Wheel	75	Chrome Plated	Sealed Precision Ball	C08CS310NPR41B-70A	2 3/4	2	7/16 x 7/8 grip ring stem
3	13/16	Black PolyFlexon®	110	Chrome Plated	Sealed Precision Ball	FH20BPC4953	3 7/8	2 7/8	7/16 x 7/8 grip ring stem

*available in dual wheel

1 1B SERIES DW DUAL WHEEL CASTERS



**Total Lock Caster with
GRAY NON-MARKING RUBBER
Precision Ball Bearings**



**Hole Caster with
GRAY NON-MARKING RUBBER
Precision Ball Bearings**

180 LBS. LOAD CAPACITY TYPE CASTERS

- Top plate: 2 3/8" x 2 3/8"
- Mounting Holes: 1 1/2" x 1 1/2" to 1 7/8" x 1 7/8" BHS 6mm hole clearance
- Custom stems available

This twin wheel version series caster offers improved mobility, better distribution of floor load, and increased capacity of a dual wheel caster. The optional "Total Lock Brake" locks both the swivel and wheel with one press of the pedal. Available in both top plate and bolt hole mounting styles.

Applications

- Office chairs
- Furniture
- Medical & institutional stands and equipment
- Diagnostic & electrical equipment

CASTER SPECIFICATIONS

Swivel Model Number	Load Capacity (lbs)	Wheel Type	Mounting Type	Weight Approx.
50mm (2") Diameter Wheels				
TWAL-50-FTP	135	Gray Non-Marking Rubber	2 3/8" x 2 3/8 top plate	1.0
TWAL-50-BH	135	Gray Non-Marking Rubber	10mm bolt hole	1.0
75mm (3") Diameter Wheels				
TWAL-75-FTP	180	Gray Non-Marking Rubber	2 3/8" x 2 3/8 top plate	2.0
TWAL-75-BH	180	Gray Non-Marking Rubber	12.2 bolt hole	1.5

Total Lock Brakes available. Add code code TLB to model number example: TWAL/TLB-75BH
Other sizes available.

1 1DW SERIES DUAL WHEEL CASTERS

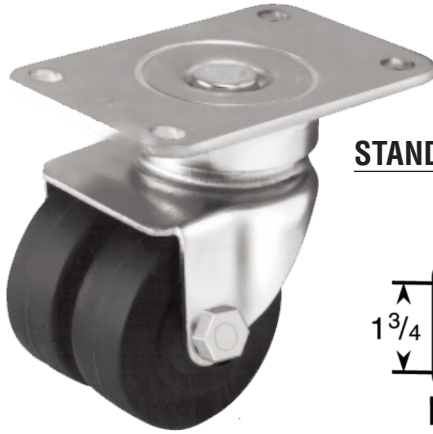

STANDARD TOP PLATE 20

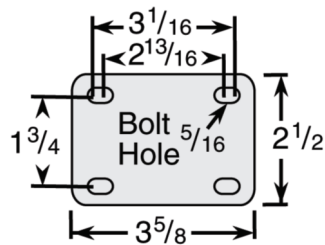

**ADDITIONAL
TOP PLATES
AVAILABLE**

APPLICATIONS

- Laboratory Equipment
- Medical Equipment
- IV Stands
- Computer Stands
- Electronic Enclosures
- Copy Machines
- Disk Storage Devices
- Display Racks
- Airport Terminal Stands

FOUR SIDED DOUBLE BALL BEARING RACEWAY 30 SERIES

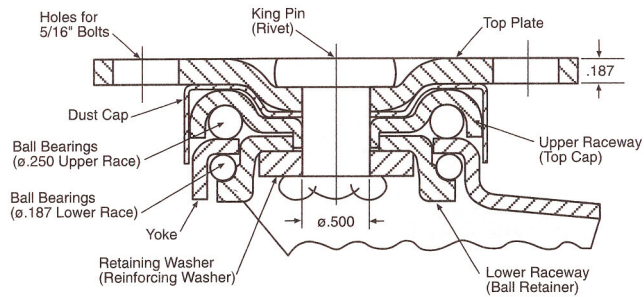

400 LBS. LOAD CAPACITY TYPE CASTERS

- Four-sided, double ball raceway
- Heat treated moving parts
- Raceway dust cap
- Low overall height
- Thumb style wheel brake
- Conductive or static dissipative wheels
- Gray, non-marking wheels
- Standard bright zinc or black oxide finishes
- Maintenance free swivel bearings

1 1DW SERIES DUAL WHEEL CASTERS

SPECIFICATIONS

Diameter	Tread Width	Load Capacity	Wheel Description	Bearing	Swivel Part Number	Rigid Part Number	Approx. Weight (lbs)	Overall Height (inch)	Swivel Radius (inch)
2	7/8	250	Round Donut/Neoprene	Ball	32-20-XDN-RD	32-20-XRDN-RD	2	3-1/4	2-1/4
2	7/8	250	Neoprene Rubber	Ball	32-20-XDN	32-20-XRDN	2	3-1/4	2-1/4
2	7/8	250	Hard Rubber	Ball	32-20-XH	32-20-XRH	2	3-1/4	2-1/4
2	7/8	300	Hi-Cap Neoprene	Ball	32-20-XKN	32-20-XRKN	2	3-1/4	2-1/4
2	7/8	400	Advanced Elastomer	Ball	32-20-XAE	32-20-XRAE	2	3-1/4	2-1/4
2	7/8	400	Polyolefin	Ball	32-20-XPO	32-20-XRPO	2	3-1/4	2-1/4
2-1/2	7/8	250	Neoprene Rubber	Ball	32-1/2-20-XDN	32-1/2-20-XRDN	2-1/2	3-3/4	2-5/8
2-1/2	7/8	330	Hard Rubber	Ball	32-1/2-20-XH	32-1/2-20-XRH	2-1/2	3-3/4	2-5/8
2-1/2	7/8	350	Hi-Cap Neoprene	Ball	32-1/2-20-XKN	32-1/2-20-XRKN	2-1/2	3-3/4	2-5/8
2-1/2	7/8	400	Polyurethane/Cast Iron Hub	Ball	32-1/2-20-XADI-M-CI	32-1/2-20-XRADI-M-CI	3	3-3/4	2-5/8
2-1/2	7/8	400	Advanced Elastomer	Ball	32-1/2-20-XAE	32-1/2-20-XRAE	2-1/2	3-3/4	2-5/8

* Special Order/Minimum Quantity

STEM SIZES AVAILABLE

“O” GRIP RING STEM TABLE

Dimension D	Dimension L	Stem Number
1/2”*	1-1/2”	O-12-112
5/8”	2”	O-58-2
3/4”*	2”	O-34-2
7/8”	2”	O-78-2
1”	2-1/2”	O-1-212

Other stem sizes and dimensions available.

* Special Order/Minimum Quantity

“L” TREADED STEM TABLE

Dimension T	Dimension L	Stem Number
1/2”-13	1-1/2”	L-1213-112
1/2”-13	2”	L-1213-2
5/8”-11	2”	L-5811-2
5/8”-11	2-1/2”	L-5811-212
3/4”-10	1-1/2”	L-3410-112
3/4”-10	2”	L-3410-2
3/4”-10	2-1/2”	L-3410-212

Other stem sizes and dimensions available.

* Special Order/Minimum Quantity

Original Glass Handling Casters for transport tables in the glass industry.

25.4 mm = 1 inch



Elastic Natural Rubber Ball Caster

Color Black, 70° Shore A

L = left hand R = right hand

- Temperature Range: -20°C to +80°C of short duration up to 120°C.
- Excellent cutting strength, non-marking, high wear resistance.
- Elastic properties prevent damaging.

ELASTIC RUBBER WHEEL BALL CASTER WITH THREADED STEM

Left Hand	Right Hand	A (mm)	B (mm)	C (mm)	O (mm)	P (mm)	Load Capacity kg.
RB GL 35 075	RB GR 35 075	35	54/71	87	14	75	12
RB GL 35 055	RB GR 35 055	35	54/71	92	14	55	12
RB GL 50 100	RB GR 50 100	50	69/91	107	14	100	20

ELASTIC RUBBER WHEEL BALL CASTER WITHOUT THREADED STEM

Left Hand	Right Hand	A (mm)	P (mm)	Load Capacity kg.
RB GL 35 075Z	RB GR 35 075Z	35	75	12
RB GL 35 055Z	RB GR 35 055Z	35	55	12
RB GL 50 100Z	RB GR 50 100Z	50	100	20

ELASTIC RUBBER BALL ONLY WITH PLASTIC INSERT

Ball Only	A (mm)
#SPC 35	35
#SPC 50	50

25.4 mm = 1 inch



Elastic Natural Rubber Ball

Stainless Steel Caster

Color Black, 70° Shore A

L = left hand R = right hand

- Temperature Range: -20°C to +80°C of short duration up to 120°C.
- Completely rust proof.
- Excellent cutting strength, non-marking, high wear resistance.
- Elastic properties prevent damaging.

ELASTIC RUBBER **STAINLESS STEEL** BALL CASTER WITH THREADED STEM

Left Hand	Right Hand	A (mm)	B (mm)	C (mm)	O (mm)	P (mm)	Load Capacity kg.
RB IL 35 075	RB IR 35 075	35	54/71	87	14	75	12
RB IL 50 055	RB IR 50 055	50	69/91	107	14	100	20

ELASTIC RUBBER **STAINLESS STEEL** BALL CASTER WITHOUT THREADED STEM

Left Hand	Right Hand	A (mm)	P (mm)	Load Capacity kg.
RB IL 35 075Z	RB IR 35 075Z	35	75	12
RB IL 50 100Z	RB IR 50 100Z	50	100	20

ELASTIC RUBBER BALL ONLY WITH PLASTIC INSERT

Ball Only	A (mm)
#SPC 35	35
#SPC 50	50

1 1V GLASS HANDLING CASTERS Polyurethane Ball

Original Glass Handling Casters for transport tables in the glass industry.

25.4 mm = 1 inch



Polyurethane Ball Caster

Color Light Brown, 92° Shore A

L = left hand R = right hand

- Temperature Range: -20°C to +80°C of short duration up to 120°C.
- Excellent cutting strength, non-marking, high wear resistance.
- Elastic properties prevent damaging.

POLYURETHANE WHEEL BALL CASTER WITH THREADED STEM

Left Hand	Right Hand	A (mm)	B (mm)	C (mm)	O (mm)	P (mm)	Load Capacity kg.
WK GL 35 075	WK GR 35 075	35	54/71	87	14	75	12
WK GL 35 055	WK GR 35 055	35	54/71	92	14	55	12
WK GL 50 100	WK GR 50 100	50	69/91	107	14	100	20

POLYURETHANE WHEEL BALL CASTER WITHOUT THREADED STEM

Left Hand	Right Hand	A (mm)	P (mm)	Load Capacity kg.
WK GL 35 075Z	WK GR 35 075Z	35	75	12
WK GL 35 055Z	WK GR 35 055Z	35	55	12
WK GL 50 100Z	WK GR 50 100Z	50	100	20

POLYURETHANE BALL ONLY WITH PLASTIC INSERT

Ball Only	A (mm)
#SPW 35	35
#SPW 50	50

25.4 mm = 1 inch



Polyurethane Ball Caster

Stainless Steel Caster

Color Light Brown, 92° Shore A

L = left hand R = right hand

- Temperature Range: -20°C to +80°C of short duration up to 120°C.
- Completely rust proof.
- Excellent cutting strength, non-marking, high wear resistance.
- Elastic properties prevent damaging.

POLYURETHANE STAINLESS STEEL BALL CASTER WITH THREADED STEM

Left Hand	Right Hand	A (mm)	B (mm)	C (mm)	O (mm)	P (mm)	Load Capacity kg.
WK IL 35 075	WK IR 35 075	35	54/71	87	14	75	12
WK IL 50 100	WK IR 50 100	50	69/91	107	14	100	20

POLYURETHANE STAINLESS STEEL BALL CASTER WITHOUT THREADED STEM

Left Hand	Right Hand	A (mm)	P (mm)	Load Capacity kg.
WK IL 35 075Z	WK IR 35 075Z	35	75	12
WK IL 50 100Z	WK IR 50 100Z	50	100	20

POLYURETHANE BALL ONLY WITH PLASTIC INSERT

Ball Only	A (mm)
#SPW 35	35
#SPW 50	50

1

1V GLASS HANDLING CASTERS Heat Resistant Elastic Rubber Ball

Original Glass Handling Casters for transport tables in the glass industry.

25.4 mm = 1 inch



Heat Resistant Ball Caster Elastic Rubber

Color Red, 80° Shore A

L = left hand R = right hand

- Temperature Range: -20°C to +150°C.
- Heat Resistant.
- Excellent cutting strength, non-marking, high wear resistance.
- Elastic properties prevent damage.

HEAT RESISTANT ELASTIC RUBBER WHEEL BALL CASTER WITH THREADED STEM

Left Hand	Right Hand	A (mm)	B (mm)	C (mm)	O (mm)	P (mm)	Load Capacity kg.
RH GL 35 075	RH GR 35 075	35	54/71	87	14	75	12
RH GL 35 055	RH GR 35 055	35	54/71	92	14	55	12
RH GL 50 100	RH GR 50 100	50	69/91	107	14	100	20

HEAT RESISTANT ELASTIC RUBBER WHEEL BALL CASTER WITHOUT THREADED STEM

Left Hand	Right Hand	A (mm)	P (mm)	Load Capacity kg.
RH GL 35 075Z	RH GR 35 075Z	35	75	12
RH GL 35 055Z	RH GR 35 055Z	35	55	12
RH GL 50 100Z	RH GR 50 100Z	50	100	20

HEAT RESISTANT ELASTIC RUBBER BALL ONLY WITH PLASTIC INSERT

Ball Only	A (mm)
#SPH 35	35
#SPH 50	50

Glass Handling Casters are also used for easy handling of other flat sheet materials such as:

- Granite
- Wood
- Plastic
- Paper

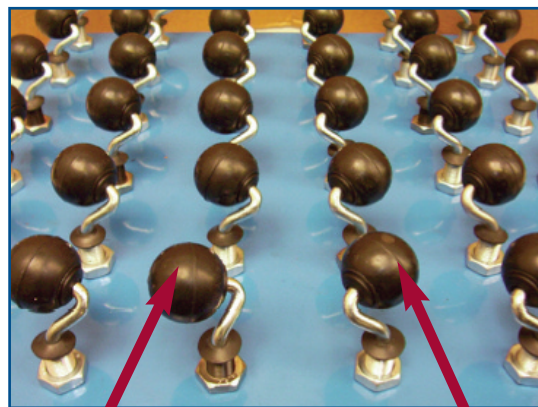

LH Caster bias moves toward the Right

RH Caster bias moves toward the Left

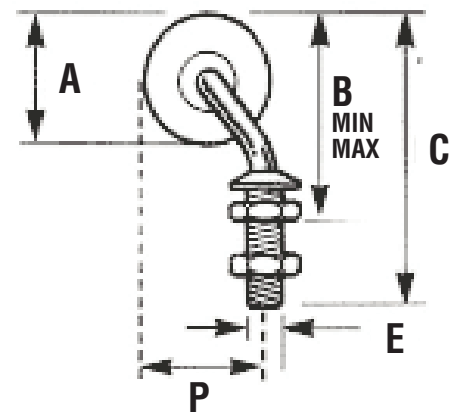

1 kg = 2.2 lbs
25.4 mm = 1 inch



Plate Swivel Caster

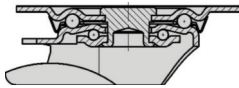

PLATE TYPE FEATURES

Load Capacity Up to 220 lbs. (100 kg.)

Casters: Pressed steel, swivel bracket with double ball bearing in the swivel head, bolted wheel axle, zinc-plated.

Wheels: Polyurethane, firmly bonded, color light brown, non-marking, 92° shore A, elastic, abrasion-resistant, high cut and tear propagation resistance, non-staining, floor-saving, low-noise operation, low rolling resistance. Very good chemical connection with the wheel center.

Made of steel **with precision ball bearings.**

SWIVEL CASTER WITH POLYURETHANE WHEELS

25.4 mm = 1 inch

Wheel Dia. (mm)	Wheel Width (mm)	Capacity (lb)	Bearing Type	OAH (mm)	Plate (mm)	Bolt Hole Spacing (mm)	Bolt Hole (mm)	Offset (mm)	Swivel Part Number
35	27	220	Precision Ball	52	60 x 60	38 x 38 / 48 x 48	6, 5	15	1NWK0350GR0
45	27	220	Precision Ball	62	60 x 60	38 x 38 / 48 x 48	6, 5	15	1NWK0450GR0
55	27	220	Precision Ball	72	60 x 60	38 x 38 / 48 x 48	6, 5	15	1NWK0550GR0



Hole Swivel Caster

HOLE TYPE FEATURES

Load Capacity Up to 220 lbs. (100 kg.)

Casters: Pressed steel, swivel bracket with double ball bearing in the swivel head, bolted wheel axle, zinc-plated.

Wheels: Made of polyurethane, firmly bonded, color light brown, non-marking, 92° shore A, elastic, abrasion-resistant, high cut and tear propagation resistance, non-staining, floor-saving, low-noise operation, low rolling resistance. Very good chemical connection with the wheel center.

Made of steel **with precision ball bearings.**

HOLE CASTER WITH POLYURETHANE WHEELS

25.4 mm = 1 inch

Wheel Dia. (mm)	Wheel Width (mm)	Capacity (lb)	Bearing Type	OAH (mm)	Plate (mm)	Bolt Hole (mm)	Offset (mm)	Swivel Part Number
35	27	220	Precision Ball	52	43	11	15	1NWK0350QR0
45	27	220	Precision Ball	62	43	11	15	1NWK0450QR0
55	27	220	Precision Ball	72	43	11	15	1NWK0550QR0

Nylacron wheels are available with precision ball bearings for all sizes.

Stems available on request.

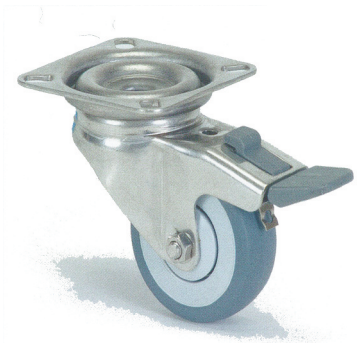

Total Lock Swivel Plate Caster
also available in Rigid and Swivel.

PLATE TYPE FEATURES

Thermoplastic Rubber Polypropylene Wheel Center on Polypropylene core. 90° Shore A: color gray, non-marking, smoothly rolling, 2RS precision ball bearing.

Mounted in a pressed stainless steel castor with double ball race: sealed, smooth rolling and pivoting - type: swivel, swivel + brake, fixed.

APPLICATIONS

- Temperature Range: -20°C to +60°C.
- Fully rust proof.
- Suitable for lighter applications, even on irregular to bad floors.
- Various applications in the construction of apparatus, furniture industry, and movement of shop equipment.

STAINLESS STEEL PLATE CASTER TPR WHEEL

25.4 mm = 1 inch

Swivel	Total Lock	Rigid	Wheel Diameter (mm)	Tread Width (mm)	Top Plate Size (mm)	Bolt Hole Spacing (mm)	Bolt Hole Diameter (mm)	Swivel Radius (mm)	Precision Ball Bearing (mm)	Overall Height (mm)	Load Capacity kg.
RT WK 050 IJU	RT WK 050 IJUS	RT WK 050 IVU	50	18	60x60	48x48	6	25	PB	69	40
RT WK 075 IJU	RT WK 075 IJUS	RT WK 075 IVU	75	25	60X60	48x48	8	24	PB	100	75



Total Lock Swivel Hole Caster

HOLE TYPE FEATURES

Thermoplastic Rubber Polypropylene Wheel Center on Polypropylene core. 90° Shore A: color gray, non-marking, smoothly rolling, 2RS precision ball bearing.

Mounted in a pressed stainless steel castor with double ball race: sealed, smooth rolling and pivoting - type: swivel, swivel + brake, fixed.

APPLICATIONS

- Temperature Range: -20°C to +60°C.
- Fully rust proof.
- Suitable for lighter applications, even on irregular to bad floors.
- Various applications in the construction of apparatus, furniture industry, and movement of shop equipment.

STAINLESS STEEL SWIVEL HOLE CASTER TPR WHEEL

25.4 mm = 1 inch

Swivel	Total Lock	Wheel Diameter (mm)	Tread Width (mm)	Swivel Radius (mm)	Top Plate Size (mm)	Hole Size (mm)	Precision Ball Bearing (mm)	Overall Height (mm)	Load Capacity kg.
RT WK 050 IJC	RT WK 050 IJCS	50	18	12	25	10	PB	69	40
RT WK 075 IJC	RT WK 075 IJCS	75	25	12	24	12	PB	100	75