



**CASTERS & WHEELS
STANDARD/STAINLESS/CUSTOM
US TOP PLATES & STEMS**



INNOVATIVE SOLUTIONS CASTERS & WHEELS

Our mission is to provide
ergonomic & safety solutions for
all caster and wheel applications.

Service before, during and after the sale since 1957.

Table of Contents

Casters

Category	Load Capacity (lbs)	Tread Width	Wheel Diameter	Description	Pg.
Light Duty	100	7/8	2, 2½, 3	Series 01	7
	145	1	3, 4, 5	Series 06	8
	135	1	3	Chrome Series 08	9
	300	7/8, 1, 1¼	2, 2½, 3	Series 10	10
Light-Medium Duty	350	1¼	3, 3½, 4, 5	Series 21	12
	350	1¼	3, 3½, 4, 5	Series 22 - Modular Components	11
	350	1¼	3, 3½, 4, 5, 6	Series 24	14
	350	1¼	3, 3½, 4, 5, 6	Stainless Series 24	16
	400	1¼	4, 5	Series 25	18
	350	1¼	4, 5	Series 26	19
	350	1¼	3, 4, 5	Series 28	20
Medium-Heavy Duty	700	1¾	3	Series 04	22
	1000	1¾	3	Series X05	23
	1250	2	4, 5, 6, 8	Series 30	24
	1250	2	4, 5, 6, 8	Stainless Series 30	26
	1250	2	4, 5, 6, 8	Series 34	28
	1500	2, 2½	4, 5, 6, 8, 10	Series 35	30
Heavy Duty	2000	2	4, 5, 6, 8	Series 40	34
	2000	2	4, 5, 6, 8	Series 46 Hybrid Kingpin	33
	2500	2½, 3	6, 8, 10, 12	Series 60	36
XTREME Heavy Duty	3500	3	6, 8, 10, 12	Series 90	38
	6000	3	6, 8, 10, 12	Series 91	40
	6000	3	6, 8, 10, 12	Series 92	42
Pneumatic/Flat-Free	300	2, 3, 3½	6, 8, 10	Series 100	44

Wheels

Tread Category	Load Capacity (lbs)	Temp Range (°F)	Description	Part #	Pg.
Rubber	675	-45 180	Duratek High Tech Rubber Donut	PPR DTR	48
	325	-45 180	FX Thermoplastic Rubber	FX	48
	1200	-45 180	Thermoplastic Rubber Donut	TPR DPR	49
	325	-40 160	Hard Rubber Soft Rubber	HR SR	50
	2100	-40 160	Rubber Steel	RS	50
	600	-40 160	Elastic Rubber Nylon	ERN	51
	600	-30 160	Rubber Glass-filled Nylon	RN	51
Polyolefin	1200	-45 180	Polyolefin Donut & Heavy Duty	PO DPO HPO	52
	1300	-45 200	Nylon	NY	53
Polyurethane	1800	-45 180	Duratough Polyurethane Polyolefin	PTU DTU	54
	1400	-45 180	Polyurethane Polyolefin	PPU	55
	2000	-40 180	Sirius Heavy Duty Polyurethane Aluminum	TUA DUA	56
	3500	-40 180	Regal Polyurethane Ductile Steel Core	DSU	56
	1400	-45 180	Solid Polyurethane	SPU	57
	3800	-40 160	HD Solid Polyurethane Glass-filled Nylon	HU	57
	3000	-45 180	Polyurethane Glass-filled Nylon	MU MX	58
	6000	-45 180	Polyurethane on Steel Heavy Duty	PU EX	59
Phenolic Glass - filled Nylon	3500	-50 250	Phenolic	PH	60
	1400	-45 180	Glass-filled Nylon	MA	60
Hi - Temp	2600	-45 550	Hi-Temp Phenolic Hi-Temp Glass-filled Nylon	TPH TMA	61
Steel	7000	-45 800	Semi-Steel Ductile Steel	SS DS	62
	7000	-45 800	V-Groove Ductile V-Groove	VG DVG	63
Specialty	300	-40 160	Flat-Free	FF	64
	300	-40 160	Full Pneumatic	FP	64
	550	-40 160	Semi-Pneumatic	SNP	64
Parts & Accessories	Delrin Bearings Roller Bearings Precision Ball Bearings Spanner Bushings Top Hat Bushings				66
	Annular Ball Bearings Flanged Ball Bearings Axles & Nuts Retainer Washers				
	Brake Kits & Swivel Locks				
	Floor Locks Caster Pads Raceway Seals Bumpers Thread Guards Expandable Adapters				

C 24 TS 5 14 PO 11 E- 01- S

Finish #	Series #	Caster Yoke Brakes		Wheel Dia.		Wheel Width		Wheel Type	Bearing Type		Wheel Color		Fastening #	Options	
		#	Type	#	Di.	#	TW		#	I.D.	#	Desc.		#	Type
Zinc (Standard)	01	CS	Swivel Yoke	2	2	78	7/8	PPR	1*	Annular Ball	A	Black Gray	00	Z	Zerk Axle
Unplated	04	CR	Rigid Yoke	25	2-1/2	10	1	DTR	11	3/8	B	Black	01	S	Raceway Seal
Chrome	05	TL	Total Lock Brake	3	3	14	1-1/4	FX	2*	Roller	C	Green Gray	02	TG	Steel Thread Guard
Black Oxide	06	DL	Directional Lock	34	3-1/4	15	1-1/2	TPR	21	1/2	D	Red Gray	03	T	High Temp Grease
Black Powder	08	SL	Side Lock Brake	35	3-1/2	113	1-13/16	DPR	22	5/8	E	White	04	PSL	4-Position Swivel Lock
Stainless Steel	10	MS	Cam Lock Swivel Brake	4	4	20	2	HR	23	3/4	F	Maroon Black	05	RWS	Steel Retainer Washers
	21	MR	Cam Lock Rigid Brake	5	5	25	2-1/2	SR	25	1	G	Green Black	06		
	22	TS	Top Lock Rigid Brake	6	6	275	2-3/4	RS	26	1-1/4	H	Gray Black	23		
	24	TR	Top Lock Swivel Brake	8	8	30	3	ERN	27	1-1/2	J	Maroon Gray	27		
	25	VS	Vertical Lock Brake	10	10	35	3-1/2	RN	3*	Precision Ball	K	Red Black	28		
	26	HS	Posi-Lock Brake	12	12	40	4	PO	31	5/16	L	Blue	30		
	28	FS	Face Contact Brake			50	5	DPO	34	3/8	M	Yellow	31		
	30	RS	Thumb Screw Brake					HPO	38	1/2	N	Green	33		
	34							NY	39R	3/4 Single Groove	O	Orange Red Gray	40		
	35							PTU	39D	3/4 Double Groove	P	Purple Gray	41		
	40							DTU	40D	1 Double Groove	Q	Purple Beige	43		
	46							PPU	62	6202 (3/8 Bushing)	R	Red	47		
	60							TUA	63	6203 (1/2 Bushing)	S	Silver	52		
	90							DUA	64	6204 (1/2 Bushing)	T	Brown	58		
	91							DSU	65	6205 (3/4 Bushing)	U	Blue Black	64		
	92							SPU	4*	Flanged Ball	V	Red Silver	70		
	100							HU	41	5/16	W	Black White	71		
								MU	42	3/8	X	Gray	72		
								MX	44	1/2	Y	Gray Beige	74		
								PU	45	5/8	Z	Blue Gray	77		
								EX	46	3/4			78		
								PH	5*	Deirtn			90		
								MA	56	1/2			91		
								TPH	57	3/4			92		
								TMA	8*	Plain Bore			93		
								SS	80	1/4			94		
								VG	81	5/16			95		
								DS	82	3/8			96		
								DVG	83	1/2			97		
								FF	84	1-3/16					
								FP	85	1-3/8					
								SNP	86	1-15/16					
									87	2-7/16					
									88	3/4					
									89	7/8					

Fastening Part Number System

Plate #	Plate Size	Bolt Hole Pattern
00	1-1/4 x 2-1/16	13/16 x 1-9/16
01	2-3/8 x 3-5/8	1-3/4 x 2-7/8 to 3
02	3-1/8 x 4-1/8	1-3/4 x 2-15/16 to 2-3/8 x 3-3/8
03	4 x 4-1/2	2-5/8 x 3-5/8 to 3 x 3
04	4-1/2 x 6-1/4	2-7/16 x 4-15/16 to 3-3/8 x 5-1/4
05	5 x 5-1/2	4-1/8 x 4-1/2
06	5-1/4 x 7-1/4	3-3/8 x 5-1/4 to 4-1/8 x 6-1/8

Stem #	Stem Type	Stem Size
23	Hollow Kingpin	7/16
27	Hollow Kingpin	M10
28	Hollow Kingpin	M12
30	Threaded Stem	3/8-16 x 3/4
31	Threaded Stem	3/8-16 x 1
33	Threaded Stem	3/8-16 x 1-1/2
40	Threaded Stem	1/2-13 x 3/4
41	Threaded Stem	1/2-13 x 1
43	Threaded Stem	1/2-13 x 1-1/2
47	Threaded Stem	1/2-13 x 2-9/16
52	Threaded Stem	3/4-10 x 1-3/4
58	Pipe Thread	3/4 NPT x 1
64	Round Stem	1 x 2-1/2; 1 Cross-drill Hole (.40 dia)
70	Grip Ring	7/16 x 1
71	Grip Ring	7/16 x 1-3/16
72	Grip Ring	7/16 x 1-3/8
74	Grip Ring	7/16 x 2
77	Grip Ring	0.845 x 2-3/16
78	Grip Ring	0.865 x 2-3/16
90	Expandable Adapter	0.720 - 0.851 (for 3/4)
91	Expandable Adapter	0.852 - 0.927 (for 7/8)
92	Expandable Adapter	0.928 - 1.029 (for 1)
93	Expandable Adapter	1.030 - 1.140 (for 1-1/8)
94	Expandable Adapter	1.141 - 1.359 (for 1-1/4)
95	Expandable Adapter	1.360 - 1.425 (for 1-3/8)
96	Expandable Adapter	1.426 - 1.589 (for 1-1/2)
97	Expandable Adapter	1.790 - 1.850 (for 1-7/8)

Light Duty Casters



01 Series
page 5



06 Series
page 6



C08 Series
page 7

Light-Medium Duty Casters



10 Series
page 8



21 Series
page 10-11



22 Series
page 9



24 Series
page 12-13



S24 Series
page 14-15



25 Series
page 16



26 Series
page 17



28 Series
page 18



The Official Office Caster



The caster for any occasion. The 01 Series is an extremely versatile caster capable of handling all of your light duty needs.

Features

- Ball bearing raceway
- Zinc plated finish
- Riveted axle



Light Duty Caster



Load Capacity
100 lbs
45 kg

Industries and Applications



Medical



Office Equipment



Display Stands



Food Service



Institutional

Caster Type	Part #
Swivel	CS
Rigid	CR
Swivel/Posi-Lock Brake	HS
Swivel/Side Lock Brake	SL

Size	Mounting Bolt Dia.	Bolt Pattern	**Plate
1-1/4 x 2-1/16	1/4	13/16 x 1-9/16	00

Size	Stem Type	**Stem
3/8-16 x 1	Threaded Stem	31
3/8-16 x 1-1/2	Threaded Stem	33
7/16 x 1-3/16	Grip Ring Stem	71

Wheel Dia.	Tread Width	Wheel Type	Load Cap.	OAH	Radius	Bearing	Swivel Part #
2	7/8	Thermoplastic Rubber	90	2-5/8	1-13/16	Plain Bore	01 CS 278TPR80- **
2	7/8	Soft Rubber	90	2-5/8	1-13/16	Plain Bore	01 CS 278SR80- **
2	7/8	Hard Rubber	100	2-5/8	1-13/16	Plain Bore	01 CS 278HR80- **
2	7/8	Polyurethane on Polyolefin	100	2-5/8	1-13/16	Plain Bore	01 CS 278PPU80- **
2	7/8	Polyolefin	100	2-5/8	1-13/16	Plain Bore	01 CS 278PO80- **
2-1/2	7/8	Thermoplastic Rubber	90	3-1/8	2-1/16	Plain Bore	01 CS 2578TPR80- **
2-1/2	7/8	Soft Rubber	90	3-1/8	2-1/16	Plain Bore	01 CS 2578SR80- **
2-1/2	7/8	Hard Rubber	100	3-1/8	2-1/16	Plain Bore	01 CS 2578HR80- **
2-1/2	7/8	Polyurethane on Polyolefin	100	3-1/8	2-1/16	Plain Bore	01 CS 2578PPU80- **
2-1/2	7/8	Polyolefin	100	3-1/8	2-1/16	Plain Bore	01 CS 2578PO80- **
3	7/8	Thermoplastic Rubber	90	3-5/8	2-3/8	Plain Bore	01 CS 378TPR80- **
3	7/8	Soft Rubber	90	3-5/8	2-3/8	Plain Bore	01 CS 378SR80- **
3	7/8	Hard Rubber	100	3-5/8	2-3/8	Plain Bore	01 CS 378HR80- **
3	7/8	Polyurethane on Polyolefin	100	3-5/8	2-3/8	Plain Bore	01 CS 378PPU80- **
3	7/8	Polyolefin	100	3-5/8	2-3/8	Plain Bore	01 CS 378PO80- **

06 Series

Consistently Serving
the Service Industry

The ideal series for all types of carts.

Features

- Double ball bearing raceways
- Zinc plated finish



Light
Duty
Caster



Load Capacity

145 lbs
65 kg



Industries and Applications



Utility Carts



Food Service



Institutional



Display Stands

Caster Type	Part #
Swivel	CS
Rigid	CR
Swivel/Side Lock Brake	SL

Size	Bolt Pattern	Attaching Bolt Dia.	**Plate
2-3/8 x 3-5/8	1-3/4 x 2-7/8 to 3	5/16	01

Size	Stem Type	**Stem
1/2-13 x 1-1/2	Threaded Stem	43
1/2-13 x 2-9/16	For Expandable Adaptor	47
7/16 x 1-3/8	Grip Ring Stem	72
7/16 x 2	Grip Ring Stem	74

Wheel Dia.	Tread Width	Wheel Type	Load Cap.	OAH	Radius	Bearing	Swivel Part #
3	1	Soft Rubber	100	3-5/8	2-3/4	Plain Bore	06 CS 310SR81-**
3	1	Thermoplastic Rubber	100	3-5/8	2-3/4	Plain Bore	06 CS 310TPR81-**
3	1	Hard Rubber	125	3-5/8	2-3/4	Plain Bore	06 CS 310HR81-**
3	1	Polyurethane on Polyolefin	125	3-5/8	2-3/4	Plain Bore	06 CS 310PPU81-**
3	1	Polyolefin	125	3-5/8	2-3/4	Plain Bore	06 CS 310PO81-**
4	1	Soft Rubber	125	4-5/8	3-3/8	Plain Bore	06 CS 410SR81-**
4	1	Thermoplastic Rubber	125	4-5/8	3-3/8	Plain Bore	06 CS 410TPR81-**
4	1	Hard Rubber	140	4-5/8	3-3/8	Plain Bore	06 CS 410HR81-**
4	1	Polyurethane on Polyolefin	140	4-5/8	3-3/8	Plain Bore	06 CS 410PPU81-**
4	1	Polyolefin	140	4-5/8	3-3/8	Plain Bore	06 CS 410PO81-**
5	1	Soft Rubber	130	5-5/8	3-1/2	Plain Bore	06 CS 510SR81-**
5	1	Thermoplastic Rubber	130	5-5/8	3-1/2	Plain Bore	06 CS 510TPR81-**
5	1	Hard Rubber	145	5-5/8	3-1/2	Plain Bore	06 CS 510HR81-**
5	1	Polyurethane on Polyolefin	145	5-5/8	3-1/2	Plain Bore	06 CS 510PPU81-**
5	1	Polyolefin	145	5-5/8	3-1/2	Plain Bore	06 CS 510PO81-**

Sleek And Quiet Mobility

The elegant and stylish 08 Series is designed for frequent movement. This caster is perfect for quiet environments.

Features

- Precision ball bearings
- Double ball raceways
- Luster polished chrome finish
- Soft, quiet, non-marking neoprene tread wheel



Light Duty Caster



Load Capacity
135 lbs
62 kg

Industries and Applications



Medical



Chairs/Mobility



Electronics



Display Stands

Caster Option	Suffix	Caster Type	Part #
Chrome Dust Cover	SC	Swivel	CS
		Integrated Posi-Lock Brake	HS

Size	Stem Type	**Stem
11mm I.D.	Hollow Kingpin	23
3/8-16 x 1-1/2	Threaded Stem	33
7/16 x 1	Grip Ring Stem	70
7/16 x 7/8	Grip Ring Stem	70A
7/16 x 1-3/8	Grip Ring Stem	72

Wheel Dia.	Tread Width	Wheel Type	Load Cap.	OAH	Radius	Bearing	Swivel Part #
3	1	Neoprene Rubber	135	3-7/8	2-13/16	Precision Ball	C08 CS 310NPR41B- **

Suffix	SC	Part #	HS	**Stem	33	**Stem	70	**Stem	72
Chrome Dust Cover		Integrated Posi-Lock Brake							



10 Series

General Duty
Multiple Applications

This General Duty caster is perfect for freezers, refrigeration units, vending machines, food service equipment, toolboxes and much more

Features

- Deeply embossed single ball bearing raceway
- Zinc plated finish



Light-Medium
Duty
Caster



Load Capacity

300 lbs
135 kg

Industries and Applications



Toolboxes



Bakery Racks



Dollies



Food Service

Caster Type	Part #
Swivel	CS
Rigid	CR
Swivel/Side Lock Brake	SL

Wheel Dia.	Overall Swivel Plate Size	Swivel Plate Bolt P. pattern	Overall Rigid Plate Size	Rigid Plate Bolt P. pattern	Plate Thickness	Axle Dia.	Attaching Bolt Dia.
2	1-7/8 x 2-9/16	15/16 x 2-1/8	1-1/2 x 2-21/32	15/16 x 2-1/8	1/16	1/4	1/4
2-1/2	2-3/8 x 3-5/8	1-3/4 x 3	2-1/4 x 4-7/16	1-1/16 x 3-1/2	1/16	5/16	1/4
3	3-1/8 x 4-1/8	2-3/8 x 3-3/8	2-1/4 x 5-1/8	1-3/16 x 4	1/16	3/8	1/4

Wheel Dia.	Tread Width	Wheel Type	Load Cap.	OAH	Radius	Bearing	Swivel Part #
2	7/8	Soft Rubber	90	2-7/16	1-3/4	Plain Bore	10 CS 278SR80B
2	7/8	Hard Rubber	100	2-7/16	1-3/4	Plain Bore	10 CS 278HR80B
2	7/8	Polyolefin	100	2-7/16	1-3/4	Plain Bore	10 CS 278PO80B
2-1/2	1	Soft Rubber	95	3-1/4	2-3/8	Plain Bore	10 CS 2510SR81B
2-1/2	1	Hard Rubber	115	3-1/4	2-3/8	Plain Bore	10 CS 2510HR81B
2-1/2	1	Polyolefin	115	3-1/4	2-3/8	Plain Bore	10 CS 2510PO81B
3	1-1/4	Soft Rubber	175	3-5/8	2-7/16	Plain Bore	10 CS 314SR82B
3	1-1/4	Hard Rubber	275	3-5/8	2-7/16	Plain Bore	10 CS 314HR82B
3	1-1/4	Polyolefin	250	3-5/8	2-7/16	Plain Bore	10 CS 314PO82B
3	1-1/4	Semi-Steel	300	3-5/8	2-7/16	Plain Bore	10 CS 314SS82B



Modular Components

Build your own castor from modular castor parts (caster yoke, nut, and kingpin are all separate). It is the same as the 21 Series when assembled. When you require a unique configuration in 1-1/4" wide wheel casters, anything is possible

Features

- 12mm Bolt Kingpin; nut 3/8 (heat treated)
- 5/32 (4mm) top plate cold forged
- 1/8 (3mm) yoke: heavy gauge cold rolled steel
- Double ball bearing raceways
- Zinc plated finish

22-KN



Light-Medium
Duty
Caster



Load Capacity
350 lbs
160 kg

Industries and Applications



Food Service



Institutional



Electronics



Office

Wheel Dia.	Tread Width	Load Cap.	OAH	Swivel Part #
3	1-1/4	300	4-3/16	22CS314
3-1/2	1-1/4	300	4-5/8	22CS3514
4	1-1/4	325	5-1/8	22CS414
5	1-1/4	350	6-1/4	22CS514

Size	Bolt Pattern	Mounting Bolt Dia.	Plate
2-3/8 x 3-5/8	1-3/4 x 2-7/8 to 3	5/16	22-01
3-1/8 x 4-1/8	1-3/4 x 2-15/16 to 2-3/8 x 3-3/8	5/16	22-02
4 x 4-1/2	2-5/8 x 3-5/8 to 3 x 3	3/8	22-03

Caster Options	Suffix
Raceway Dust Cover	DC

Size	Stem Type	Stem
3/8-16 x 1-1/2	Threaded Stem	22-33
1/2-13 x 3/4	Threaded Stem	22-40
1/2-13 x 1	Threaded Stem	22-41
1/2-13 x 1-1/2	Threaded Stem	22-43
1/2-13 x 2-9/16	Threaded Stem	22-47
3/4-10 x 1-3/4	Threaded Stem	22-52
5/8-11 x 1-3/4	Threaded Stem	22-55
3/4 NPT x 1	Pipe Thread Stem	22-58
7/16 x 1-3/8	Grip Ring Stem	22-72
7/16 x 2	Grip Ring Stem	22-74
0.845 x 2-3/16	Grip Ring Stem	22-77
0.865 x 2-3/16	Grip Ring Stem	22-78
0.720 - 0.851	Expandable Adapter	90
0.852 - 0.927	Expandable Adapter	91
0.928 - 1.029	Expandable Adapter	92
1.030 - 1.140	Expandable Adapter	93
1.141 - 1.359	Expandable Adapter	94
1.360 - 1.425	Expandable Adapter	95
1.426 - 1.589	Expandable Adapter	96
1.790 - 1.850	Expandable Adapter	97

21 Series



The Do Everything Caster

From food service to laboratories the 21 Series is strong and reliable every day of the week.

Features

- Double ball bearing raceways
- Zinc plated finish
- Heavy gauge cold rolled steel



Light-Medium Duty Caster



Load Capacity
350 lbs
160 kg

Industries and Applications



Institutional



Office



Food Service



Laboratory

Caster Pads



Features

- Allows rapid in-field caster replacement
- Heavy gauge formed steel
- Includes bolt, lock washer and nut

Plate Size	Bolt Pattern	Bolt Dia.	Part #
2-3/8 x 3-5/8	Weld On	5/16	CP-01 KIT

Size	Stem Type	**Stem
1/2-13 x 1	Threaded Stem	41
1/2-13 x 1-1/2	Threaded Stem	43
1/2-13 x 2-9/16	For Expandable Adapter	47
0.720 - 0.851	Expandable Adapter	90
0.852 - 0.927	Expandable Adapter	91
0.928 - 1.029	Expandable Adapter	92
1.030 - 1.140	Expandable Adapter	93
1.141 - 1.359	Expandable Adapter	94
1.360 - 1.425	Expandable Adapter	95
1.426 - 1.589	Expandable Adapter	96
1.790 - 1.850	Expandable Adapter	97



Size	Bolt Pattern	Attaching Bolt Dia.	**Plate
2-3/8 x 3-5/8	1-3/4 x 2-7/8 to 3	5/16	01
3-1/8 x 4-1/8	1-3/4 x 2-15/16 to 2-3/8 x 3-3/8	5/16	02
4 x 4-1/2	2-5/8 x 3-5/8 to 3 x 3	3/8	03

Caster Type	Part #
Swivel	CS
Rigid	CR
Swivel/Total Lock Brake	TL
Swivel/Top Lock Brake	TS
Swivel/Posi-Lock Brake	HS

Bearing Options	Part #
Annular	11
Roller Bearing	21
Precision Full Thread Guard	34
Precision Small Thread Guard	35
1/2 Delrin	56
3/8 Plain Bore	82
1/2 Plain Bore with Bushing	83

Wheel Dia.	Tread Width	Wheel Type	Load Cap.	OAH	Radius	Swivel Part #	Bearing Options
3	1-1/4	Yoke Only	350	-	-	21CS314-**	-
3	1-1/4	Soft Rubber	175	4-3/16	2-21/32	21CS314SR-**	82
3	1-1/4	FX Thermoplastic Rubber	225	4-3/16	2-21/32	21CS314FX-**	35
3	1-1/4	Duratek High Tech Rubber	225	4-3/16	2-21/32	21CS314PPR-**	11, 56
3	1-1/4	Polyurethane on Polyolefin	250	4-3/16	2-21/32	21CS314PPU-**	34
3	1-1/4	Polyolefin	250	4-3/16	2-21/32	21CS314PO-**	82
3	1-1/4	Hard Rubber	275	4-3/16	2-21/32	21CS314HR-**	82
3	1-1/4	Duratough Polyurethane on Polyolefin	275	4-3/16	2-21/32	21CS314PTU-**	11, 56
3	1-1/4	Nylon	300	4-3/16	2-21/32	21CS314NY-**	82
3	1-1/4	Solid Polyurethane	300	4-3/16	2-21/32	21CS314SPU-**	83
3	1-1/4	Phenolic	350	4-3/16	2-21/32	21CS314PH-**	21, 83
3	1-1/4	Semi-Steel	350	4-3/16	2-21/32	21CS314SS-**	82
3-1/2	1-1/4	Yoke Only	350	-	-	21CS3514-**	-
3-1/2	1-1/4	FX Thermoplastic Rubber	230	4-5/8	2-29/32	21CS3514FX-**	35
3-1/2	1-1/4	Duratek High Tech Rubber	250	4-5/8	2-29/32	21CS3514PPR-**	11, 56
3-1/2	1-1/4	Polyurethane on Polyolefin	275	4-5/8	2-29/32	21CS3514PPU-**	34
3-1/2	1-1/4	Duratough Polyurethane on Polyolefin	300	4-5/8	2-29/32	21CS3514PTU-**	11, 56
3-1/2	1-1/4	Phenolic	350	4-5/8	2-29/32	21CS3514PH-**	21, 83
4	1-1/4	Yoke Only	350	-	-	21CS414-**	-
4	1-1/4	Soft Rubber	220	5-1/8	3-7/32	21CS414SR-**	82
4	1-1/4	FX Thermoplastic Rubber	300	5-1/8	3-7/32	21CS414FX-**	35
4	1-1/4	Duratek High Tech Rubber	300	5-1/8	3-7/32	21CS414PPR-**	11, 56
4	1-1/4	Polyurethane on Polyolefin	300	5-1/8	3-7/32	21CS414PPU-**	34, 35
4	1-1/4	Polyolefin	300	5-1/8	3-7/32	21CS414PO-**	82
4	1-1/4	Hard Rubber	300	5-1/8	3-7/32	21CS414HR-**	82
4	1-1/4	Duratough Polyurethane on Polyolefin	325	5-1/8	3-7/32	21CS414PTU-**	11, 56
4	1-1/4	Nylon	350	5-1/8	3-7/32	21CS414NY-**	82
4	1-1/4	Solid Polyurethane	350	5-1/8	3-7/32	21CS414SPU-**	83
4	1-1/4	Phenolic	350	5-1/8	3-7/32	21CS414PH-**	21, 83
4	1-1/4	Semi-Steel	350	5-1/8	3-7/32	21CS414SS-**	82
5	1-1/4	Yoke Only	350	-	-	21CS514-**	-
5	1-1/4	Soft Rubber	250	6-1/4	3-13/16	21CS514SR-**	82
5	1-1/4	FX Thermoplastic Rubber	315	6-1/4	3-13/16	21CS514FX-**	35
5	1-1/4	Duratek High Tech Rubber	325	6-1/4	3-13/16	21CS514PPR-**	11, 56
5	1-1/4	Polyurethane on Polyolefin	325	6-1/4	3-13/16	21CS514PPU-**	34, 35
5	1-1/4	Polyolefin	325	6-1/4	3-13/16	21CS514PO-**	82
5	1-1/4	Hard Rubber	325	6-1/4	3-13/16	21CS514HR-**	82
5	1-1/4	Duratough Polyurethane on Polyolefin	350	6-1/4	3-13/16	21CS514PTU-**	11, 56
5	1-1/4	Nylon	350	6-1/4	3-13/16	21CS514NY-**	82
5	1-1/4	Solid Polyurethane	350	6-1/4	3-13/16	21CS514SPU-**	83
5	1-1/4	Phenolic	350	6-1/4	3-13/16	21CS514PH-**	21, 83

24 Series



Economical and Versatile

The **24 Series** is a very versatile and economic caster. They are perfect for material handling, maintenance carts, bakeries, food service, stocking carts, dollies and more!



Features

- Double ball bearing raceways
- **Heavy gauge cold rolled steel**
- Steel dust cover protects swivel raceway
- Zinc plated finish



Light-Medium Duty Caster



Load Capacity
350 lbs
160 kg



Industries and Applications



Institutional



Office



Food Service



Laboratory

Caster Pads



Features

- Allows rapid in-field caster replacement
- **Heavy gauge formed steel**
- Includes bolt, lock washer and nut

Plate Size	Bolt Pattern	Attaching Bolt Dia.	Part #
2-3/8 x 3-5/8	Weld On	5/16	CP-01 KIT

Size	Bolt Pattern	Attaching Bolt Dia.	**Plate
2-3/8 x 3-5/8	1-3/4 x 2-7/8 to 3	5/16	01
3-1/8 x 4-1/8	1-3/4 x 2-15/16 to 2-3/8 x 3-3/8	5/16	02
4 x 4-1/2	2-5/8 x 3-5/8 to 3 x 3	3/8	03

Size	Stem Type	**Stem
1/2-13 x 1	Threaded Stem	41
1/2-13 x 1-1/2	Threaded Stem	43
1/2-13 x 2-9/16	Threaded Stem	47
7/16 x 1-3/8	Grip Ring Stem	72
0.720 - 0.851	Expandable Adapter	90
0.852 - 0.927	Expandable Adapter	91
0.928 - 1.029	Expandable Adapter	92
1.030 - 1.140	Expandable Adapter	93
1.141 - 1.359	Expandable Adapter	94
1.360 - 1.425	Expandable Adapter	95
1.426 - 1.589	Expandable Adapter	96
1.790 - 1.850	Expandable Adapter	97

Caster Type	Part #
Swivel	CS
Rigid	CR
Swivel/Top Lock Brake	TS
Swivel/Posi-Lock Brake	HS

Bearing Options	Part #
Annular	11
Roller Bearing	21
Precision Full Thread Guard	34
Precision Small Thread Guard	35
3/8 Precision Ball	42
1/2 Delrin	56
3/8 Plain Bore	82
1/2 Plain Bore with Bushing	83

Wheel Dia.	Tread Width	Wheel Type	Load Cap.	OAH	Radius	Swivel Part #	Bearing Options
3	1-1/4	Yoke Only	350	-	-	24CS314-**	-
3	1-1/4	Soft Rubber	175	4-3/16	2-21/32	24CS314SR-**	82
3	1-1/4	FX Thermoplastic Rubber	225	4-3/16	2-21/32	24CS314FX-**	35
3	1-1/4	Duratek High Tech Rubber	225	4-3/16	2-21/32	24CS314PPR-**	11, 56
3	1-1/4	Polyurethane on Polyolefin	250	4-3/16	2-21/32	24CS314PPU-**	34
3	1-1/4	Polyolefin	250	4-3/16	2-21/32	24CS314PO-**	82
3	1-1/4	Hard Rubber	275	4-3/16	2-21/32	24CS314HR-**	82
3	1-1/4	Duratough Polyurethane on Polyolefin	275	4-3/16	2-21/32	24CS314PTU-**	11, 56
3	1-1/4	Nylon	300	4-3/16	2-21/32	24CS314NY-**	82
3	1-1/4	Solid Polyurethane	300	4-3/16	2-21/32	24CS314SPU-**	83
3	1-1/4	Phenolic	350	4-3/16	2-21/32	24CS314PH-**	21, 83
3	1-1/4	Semi-Steel	350	4-3/16	2-21/32	24CS314SS-**	82
3-1/2	1-1/4	Yoke Only	350	-	-	24CS3514-**	-
3-1/2	1-1/4	FX Thermoplastic Rubber	230	4-5/8	2-29/32	24CS3514FX-**	35
3-1/2	1-1/4	Duratek High Tech Rubber	250	4-5/8	2-29/32	24CS3514PPR-**	11, 56
3-1/2	1-1/4	Polyurethane on Polyolefin	275	4-5/8	2-29/32	24CS3514PPU-**	34
3-1/2	1-1/4	Duratough Polyurethane on Polyolefin	300	4-5/8	2-29/32	24CS3514PTU-**	11, 56
3-1/2	1-1/4	Phenolic	350	4-5/8	2-29/32	24CS3514PH-**	21, 83
4	1-1/4	Yoke Only	350	-	-	24CS414-**	-
4	1-1/4	Soft Rubber	220	5-1/8	3-7/32	24CS414SR-**	82
4	1-1/4	FX Thermoplastic Rubber	300	5-1/8	3-7/32	24CS414FX-**	35
4	1-1/4	Duratek High Tech Rubber	300	5-1/8	3-7/32	24CS414PPR-**	11, 56
4	1-1/4	Polyurethane on Polyolefin	300	5-1/8	3-7/32	24CS414PPU-**	34, 35
4	1-1/4	Polyolefin	300	5-1/8	3-7/32	24CS414PO-**	82
4	1-1/4	Hard Rubber	300	5-1/8	3-7/32	24CS414HR-**	82
4	1-1/4	Duratough Polyurethane on Polyolefin	325	5-1/8	3-7/32	24CS414PTU-**	11, 56
4	1-1/4	Nylon	350	5-1/8	3-7/32	24CS414NY-**	82
4	1-1/4	Solid Polyurethane	350	5-1/8	3-7/32	24CS414SPU-**	83
4	1-1/4	Phenolic	350	5-1/8	3-7/32	24CS414PH-**	21, 83
4	1-1/4	Semi-Steel	350	5-1/8	3-7/32	24CS414SS-**	82
5	1-1/4	Yoke Only	350	-	-	24CS514-**	-
5	1-1/4	Soft Rubber	250	6-1/4	3-13/16	24CS514SR-**	82
5	1-1/4	FX Thermoplastic Rubber	315	6-1/4	3-13/16	24CS514FX-**	35
5	1-1/4	Duratek High Tech Rubber	325	6-1/4	3-13/16	24CS514PPR-**	11, 56
5	1-1/4	Polyurethane on Polyolefin	325	6-1/4	3-13/16	24CS514PPU-**	34, 35
5	1-1/4	Polyolefin	325	6-1/4	3-13/16	24CS514PO-**	82
5	1-1/4	Hard Rubber	325	6-1/4	3-13/16	24CS514HR-**	82
5	1-1/4	Duratough Polyurethane on Polyolefin	350	6-1/4	3-13/16	24CS514PTU-**	11, 56
5	1-1/4	Nylon	350	6-1/4	3-13/16	24CS514NY-**	82
5	1-1/4	Solid Polyurethane	350	6-1/4	3-13/16	24CS514SPU-**	83
5	1-1/4	Phenolic	350	6-1/4	3-13/16	24CS514PH-**	21, 83
6	1-1/4	Yoke Only	350	-	-	24CS614-**	-
6	1-1/4	Thermoplastic Rubber	325	7-1/8	4-1/2	24CS614TPR-**	35
6	1-1/4	Donut Thermoplastic Rubber	325	7-1/8	4-1/2	24CS614DPR-**	35
6	1-1/4	Polyurethane on Polyolefin	350	7-1/8	4-1/2	24CS614PPU-**	42

S24 Stainless Series



Staying Clean Behind The Scenes

These NSF certified and 100% washable casters are perfect for environments that need to stay clean. If you have medium sized lab or food service equipment, then this is your caster.

Features

- Double ball bearing raceways
- Heavy gauge cold rolled steel
- Steel dust cover protects swivel raceways



Light-Medium Duty
Caster



Load Capacity
350 lbs
160 kg

Industries and Applications



Institutional



Laboratory



Food Service



Size	Stem Type	**Stem
1/2-13 x 1	Threaded Stem	41
1/2-13 x 1-1/2	Threaded Stem	43
1/2-13 x 2-9/16	Threaded Stem	47
7/16 x 1-3/8	Grip Ring Stem	72

S24 Stainless Series

Size	Bolt Pattern	Attaching Bolt Dia.	**Plate
2-3/8 x 3-5/8	1-3/4 x 2-7/8 to 3	5/16	01
3-1/8 x 4-1/8	1-3/4 x 2-15/16 to 2-3/8 x 3-3/8	5/16	02
4 x 4-1/2	2-5/8 x 3-5/8 to 3 x 3	3/8	03

Caster Type	Part #
Swivel	CS
Rigid	CR
Swivel/Posi-Lock Brake	HS

Bearing Options	Part #
Stainless Annular	S11
1/2 Delrin	56
3/8 Plain Bore	82
1/2 Plain Bore with Bushing	83

Wheel Dia.	Tread Width	Wheel Type	Load Cap.	OAH	Radius	Swivel Part #	Bearing Options
3	1-1/4	Yoke Only	350	-	-	S24 CS 314.**	-
3	1-1/4	Soft Rubber	175	4-3/16	2-21/32	S24 CS 314SR.**	82
3	1-1/4	Duratek High Tech Rubber	225	4-3/16	2-21/32	S24 CS 314PPR.**	S11, 56
3	1-1/4	Polyurethane Polyolefin	250	4-3/16	2-21/32	S24 CS 314PPU.**	56
3	1-1/4	Polyolefin	250	4-3/16	2-21/32	S24 CS 314PO.**	82
3	1-1/4	Hard Rubber	275	4-3/16	2-21/32	S24 CS 314HR.**	82
3	1-1/4	Duratough Polyurethane Polyolefin	275	4-3/16	2-21/32	S24 CS 314PTU.**	S11, 56
3	1-1/4	Nylon	300	4-3/16	2-21/32	S24 CS 314NY.**	82
3	1-1/4	Solid Polyurethane	300	4-3/16	2-21/32	S24 CS 314SPU.**	83
3	1-1/4	Phenolic	350	4-3/16	2-21/32	S24 CS 314PH.**	83
3-1/2	1-1/4	Yoke Only	350	-	-	S24 CS 3514.**	-
3-1/2	1-1/4	Duratek High Tech Rubber	250	4-5/8	2-29/32	S24 CS 3514PPR.**	S11, 56
3-1/2	1-1/4	Polyurethane Polyolefin	275	4-5/8	2-29/32	S24 CS 3514PPU.**	56
3-1/2	1-1/4	Duratough Polyurethane Polyolefin	300	4-5/8	2-29/32	S24 CS 3514PTU.**	S11, 56
3-1/2	1-1/4	Phenolic	350	4-5/8	2-29/32	S24 CS 3514PH.**	83
4	1-1/4	Yoke Only	350	-	-	S24 CS 414.**	-
4	1-1/4	Soft Rubber	220	5-1/8	3-7/32	S24 CS 414SR.**	82
4	1-1/4	Duratek High Tech Rubber	300	5-1/8	3-7/32	S24 CS 414PPR.**	S11, 56
4	1-1/4	Polyurethane Polyolefin	300	5-1/8	3-7/32	S24 CS 414PPU.**	56
4	1-1/4	Polyolefin	300	5-1/8	3-7/32	S24 CS 414PO.**	82
4	1-1/4	Hard Rubber	300	5-1/8	3-7/32	S24 CS 414HR.**	82
4	1-1/4	Duratough Polyurethane Polyolefin	325	5-1/8	3-7/32	S24 CS 414PTU.**	S11, 56
4	1-1/4	Nylon	350	5-1/8	3-7/32	S24 CS 414NY.**	82
4	1-1/4	Solid Polyurethane	350	5-1/8	3-7/32	S24 CS 414SPU.**	83
4	1-1/4	Phenolic	350	5-1/8	3-7/32	S24 CS 414PH.**	83
5	1-1/4	Yoke Only	350	-	-	S24 CS 514.**	-
5	1-1/4	Soft Rubber	250	6-1/4	3-13/16	S24 CS 514SR.**	82
5	1-1/4	Duratek High Tech Rubber	325	6-1/4	3-13/16	S24 CS 514PPR.**	S11, 56
5	1-1/4	Polyurethane Polyolefin	325	6-1/4	3-13/16	S24 CS 514PPU.**	56
5	1-1/4	Polyolefin	325	6-1/4	3-13/16	S24 CS 514PO.**	82
5	1-1/4	Hard Rubber	325	6-1/4	3-13/16	S24 CS 514HR.**	82
5	1-1/4	Duratough Polyurethane Polyolefin	350	6-1/4	3-13/16	S24 CS 514PTU.**	S11, 56
5	1-1/4	Nylon	350	6-1/4	3-13/16	S24 CS 514NY.**	82
5	1-1/4	Solid Polyurethane	350	6-1/4	3-13/16	S24 CS 514SPU.**	83
5	1-1/4	Phenolic	350	6-1/4	3-13/16	S24 CS 514PH.**	83
6	1-1/4	Yoke Only	350	-	-	S24 CS 614.**	-
6	1-1/4	Thermoplastic Rubber	325	7-1/8	4-1/2	S24 CS 614TPR.**	56
6	1-1/4	Donut Thermoplastic Rubber	325	7-1/8	4-1/2	S24 CS 614DPR.**	56

25 Series



Elegance Meets Professional Mobility

The **25 Series** has directional and total lock brake options, including a chrome brake pedal for maximum maneuverability.

Features

- Double ball bearing raceways
- Heavy gauge cold rolled steel
- Integrated dual pedal brake
- Safe, quiet and non-marking
- Plastic grease seal on swivel raceway
- Chrome plated option available



Light-Medium Duty Caster



Load Capacity
400 lbs
180 kg

Industries and Applications



Medical



Laboratory



Office



Electronics

Size	Bolt Pattern	Attaching Bolt Dia.	**Plate
2-3/8 x 3-5/8	1-3/4 x 2-7/8 to 3	5/16	01

Size	Stem Type	**Stem
1/2-13 x 1	Threaded Stem	41
1/2-13 x 1-1/2	Threaded Stem	43
1/2-13 x 2-9/16	Threaded Stem	47

Caster Type	Lock #
Swivel	CS
Swivel/Total Lock	TL
Swivel/Directional Lock	DL

Option	Prefix
Chrome Plated	C
With Chrome Brake	M

Bearing Options	^Part #
Annular	11
Precision Full Thread Guard	34
Precision Small Thread Guard	35
1/2 Delrin	56
1/2 Plain Bore with Bushing	83

Special Order

Wheel Dia.	Tread Width	Wheel Type	Load Cap.	OAH	Radius	Swivel Part #	Bearing Options
4	1-1/4	FX Thermoplastic Rubber	300	5-1/2	3-1/2	25CS414FX^**	11, 56
4	1-1/4	Duratek High Tech Rubber	300	5-1/2	3-1/2	25CS414PPR^**	11, 56
4	1-1/4	Polyurethane Polyolefin	300	5-1/2	3-1/2	25CS414PPU^**	34, 35
4	1-1/4	Duratough Polyurethane Polyolefin	325	5-1/2	3-1/2	25CS414PTU^**	11, 56
4	1-1/4	Solid Polyurethane	400	5-1/2	3-1/2	25CS414SPU^**	83
5	1-1/4	FX Thermoplastic Rubber	315	6-1/2	4	25CS514FX^**	11, 56
5	1-1/4	Duratek High Tech Rubber	325	6-1/2	4	25CS514PPR^**	11, 56
5	1-1/4	Polyurethane Polyolefin	325	6-1/2	4	25CS514PPU^**	34, 35
5	1-1/4	Duratough Polyurethane Polyolefin	350	6-1/2	4	25CS514PTU^**	11, 56
5	1-1/4	Solid Polyurethane	400	6-1/2	4	25CS514SPU^**	83



Quiet, Smooth and Long Lasting

The **26 Series** offers both shopping cart and convertible handtruck casters specifically engineered to perform in a smooth, quiet and long lasting application.

Features

- Double ball bearing hardened raceways
- Heavy gauge cold rolled steel
- Sealed upper raceway
- Key lock base



Light-Medium
Duty
Caster



Load Capacity
350 lbs
160 kg

Industries and Applications



Retail



Handtrucks



Shopping Carts

Size	Stem Type	Application	**Stem
1/2-13 x 3/4	Threaded Stem	Shopping Carts	40
1 x 2-1/2	Round Stem	Handtrucks	64

Bearing Options	Part #
Annular	11
Precision Small Thread Guard	35

Wheel Dia.	Tread Width	Wheel Type	Load Cap.	OAH	Radius	Swivel Part #	Bearing
4	1-1/4	Yoke Only	350	-	-	26 CS 414-**	-
4	1-1/4	FX Thermoplastic Rubber	300	4-15/16	3-1/2	26 CS 414FX35-**	35
4	1-1/4	Duratek High Tech Rubber	300	4-15/16	3-1/2	26 CS 414PPR11-**	11
4	1-1/4	Polyurethane Polyolefin	300	4-15/16	3-1/2	26 CS 414PPU35-**	35
4	1-1/4	Duratough Polyurethane Polyolefin	325	4-15/16	3-1/2	26 CS 414PTU11-**	11
5	1-1/4	Yoke Only	350	-	-	26 CS 514-**	-
5	1-1/4	FX Thermoplastic Rubber	315	5-15/16	4	26 CS 514FX35-**	35
5	1-1/4	Duratek High Tech Rubber	325	5-15/16	4	26 CS 514PPR11-**	11
5	1-1/4	Polyurethane Polyolefin	325	5-15/16	4	26 CS 514PPU35-**	35
5	1-1/4	Duratough Polyurethane Polyolefin	350	5-15/16	4	26 CS 514PTU11-**	11



Shopping Cart
Threaded Stem

**Stem 40



Convertible Handtruck
Round Stem

**Stem 64

28 Series

Lab Tested Medical Grade



The 28 Series was made for laboratory and medical equipment. Its impact and chemical resistance make it perfect for hazardous environments.

Features

- Glass-filled nylon yoke construction for increased strength
- Highly impact absorbent
- Resists water chemicals solvents and oils
- Smooth precision ball bearing raceway
- Highly maneuverable and quiet



Light-Medium
Duty
Caster



Load Capacity
350 lbs
160 kg

Industries and Applications



Medical



Electronics



Laboratory



Size	Bolt Pattern	Attaching Bolt Dia.	**Plate
2-3/8 x 3-5/8	1-3/4 x 2-7/8 to 3	5/16	01

Size	Stem Type	**Stem
1/2-13 x 1	Threaded Stem	41
1/2-13 x 1-1/2	Threaded Stem	43
7/16 x 1-3/8	Grip Ring	72

Caster Type	Part #
Swivel	CS
Swivel/Total Lock Brake	TL
Swivel/Directional Lock Brake	DL

Wheel Dia.	Tread Width	Wheel Type	Load Cap.	OAH	Radius	Bearing	Swivel Part #
3	1-1/4	Thermoplastic Rubber	210	4-3/4	3-1/16	Precision	28 CS 314TPR31-**
3	1-1/4	FX Thermoplastic Rubber	225	4-3/4	3-1/16	Precision	28 CS 314FX31-**
3	1-1/4	Polyurethane I Polyolefin	250	4-3/4	3-1/16	Precision	28 CS 314PPU31-**
3	1-1/4	Duratough Polyurethane I Polyolefin	275	4-3/4	3-1/16	Precision	28 CS 314PTU31-**
4	1-1/4	Thermoplastic Rubber	250	5-7/16	3-3/8	Precision	28 CS 414TPR31-**
4	1-1/4	FX Thermoplastic Rubber	300	5-7/16	3-3/8	Precision	28 CS 414FX31-**
4	1-1/4	Polyurethane I Polyolefin	300	5-7/16	3-3/8	Precision	28 CS 414PPU31-**
4	1-1/4	Duratough Polyurethane I Polyolefin	325	5-7/16	3-3/8	Precision	28 CS 414PTU31-**
5	1-1/4	Thermoplastic Rubber	300	6-1/2	4-1/2	Precision	28 CS 514TPR31-**
5	1-1/4	FX Thermoplastic Rubber	315	6-1/2	4-1/2	Precision	28 CS 514FX31-**
5	1-1/4	Polyurethane I Polyolefin	325	6-1/2	4-1/2	Precision	28 CS 514PPU31-**
5	1-1/4	Duratough Polyurethane I Polyolefin	350	6-1/2	4-1/2	Precision	28 CS 514PTU31-**

Medium-Heavy Duty Casters



04 Series
page 20



X05 Series
page 21



30 Series
page 22-23



S30 Series
page 24-25



34 Series
page 26-27



35 Series
page 28-30

Heavy Duty Casters



40 Series
page 32-33



Hybrid KP 46 Series
page 31



60 Series
page 34-35

Xtreme Heavy Duty Casters



90 Series
page 36-37



91 Series
page 38-39



92 Series
page 40-41

04 Series



Low Clearance? No Problem.

The **04 Series** of **Medium-Heavy duty** low profile machine casters are made for **heavy loads** and **low heights**.

Features

- Double ball bearing raceways
- Zinc plated finish



**Medium-Heavy
Duty
Caster**



Load Capacity
700 lbs
320 kg

Industries and Applications



Vending Machines



Electronics



Display Stands &
Racks

Size	Bolt Pattern	Attaching Bolt Dia.	**Plate
2-3/8 x 3-5/8	1-3/4 x 2-7/8 to 3	5/16	01
3-1/8 x 4-1/8	1-3/4 x 2-15/16 to 2-3/8 x 3-3/8	5/16	02
4 x 4-1/2	2-5/8 x 3-5/8 to 3 x 3	3/8	03

Caster Type	Part #
Swivel	CS
Swivel/Top Lock Brake	TS

Size	Stem Type	**Stem
1/2-13 x 1	Threaded Stem	41

Wheel Dia.	Tread Width	Wheel Type	Load Cap.	OAH	Radius	Bearing	Swivel Part #
3	1-13/16	Yoke Only	700	-	-	-	04 CS 3113-**-**
3	1-13/16	HD Polyolefin	500	4-1/4	2-3/8	Steel Bushing	04 CS 3113HPO91B-**-**
3	1-13/16	Sirius HD Donut Polyurethane Aluminum	550	4-1/4	2-3/8	Precision Ball	04 CS 3113DUA62M-**-**
3	1-13/16	Glass-filled Nylon	700	4-1/4	2-3/8	Precision Ball	04 CS 3113MA62B-**-**

X05 Series



Less Clearance More Muscle



The X05 Series is a low clearance caster with the most muscle. When space is limited and the load is heavy choose the X05 Series.



**Medium-Heavy
Duty
Caster**



Load Capacity
1000 lbs
450 kg

Features

- Double ball bearing raceways
- Black oxide finish
- ½ Zerk axle

Industries and Applications



Vending Machines



Electronics

Size	Bolt Pattern	Attaching Bolt Dia.	**Plate
3-1/8 x 4-1/8	2-3/8 x 3-3/8	5/16	02
4 x 4-1/2	2-5/8 x 3-5/8 to 3 x 3	3/8	03

Caster Type	Part #
Swivel	CS
Thumb Screw Brake	RS

Wheel Dia.	Tread Width	Wheel Type	Load Cap.	OAH	Radius	Bearing	Swivel Part #
3	1-13/16	Yoke Only	1000	-	-	-	X05 CS 3113-**
3	1-13/16	HD Polyolefin	500	4-5/32	2-3/8	Steel Bushing	X05 CS 3113HPO91B-**
3	1-13/16	Sirius HD Donut Polyurethane Aluminum	550	4-5/32	2-3/8	Precision Ball	X05 CS 3113DUA63M-**
3	1-13/16	Glass-filled Nylon	1000	4-5/32	2-3/8	Precision Ball	X05 CS 3113MA63B-**

30 Series



Tried, True and Still Going Strong

Features

- Double ball bearing raceways
- Zinc plated finish
- 5/8" diameter nut and bolt kingpin
- 1/4" cold forged steel top plate & yoke legs



Medium-Heavy Duty Caster



Load Capacity
1250 lbs
565 kg



Industries and Applications



Food Service



Platform Trucks



Industrial



Commercial

Size	Bolt Pattern	Attaching Bolt Dia.	Plate
4 x 4-1/2	2-5/8 x 3-5/8 to 3 x 3	3/8	03

Caster Type	Part #
Swivel	CS
Rigid	CR
Swivel/Top Lock Brake	TS
Swivel/Cam Lock Brake	MS
Rigid/Top Lock Brake	TR
Options	Suffix
4 Position Lock	PSL

Bearing Options	Part #
Roller	23
Q34 Precision Ball	38
1/2 I.D. Delrin	56
3/4 I.D. Delrin	57
6203 Precision Ball	63
6204 Precision Ball	64

Wheel Dia.	Tread Wid.	Wheel Type	Load Cap.	OAH	Radius	Swivel Part #	**Bearing Options
4	2	Yoke only	1250	-	-	30 CS 420-03	-
4	2	Thermoplastic Rubber	300	5-5/8	3-1/4	30 CS 420TPR**-03	23, 38, 56, 57
4	2	Donut Thermoplastic Rubber	300	5-5/8	3-1/4	30 CS 420DPR**-03	23, 38, 56, 57
4	2	Elastic Rubber Nylon	400	5-5/8	3-1/4	30 CS 420ERN**-03	23, 38, 56, 57
4	2	Rubber Steel	400	5-5/8	3-1/4	30 CS 420RS**-03	23, 38, 56, 57
4	2	Rubber Glass-filled Nylon	400	5-5/8	3-1/4	30 CS 420RN**-03	23, 38, 56, 57
4	2	Duratek High Tech Rubber	450	5-5/8	3-1/4	30 CS 420PPR**-03	23, 38, 56, 57
4	2	Duratek Donut High Tech Rubber	450	5-5/8	3-1/4	30 CS 420DTR**-03	23, 38, 56, 57
4	2	Polyurethane Polyolefin	500	5-5/8	3-1/4	30 CS 420PPU**-03	23, 38, 56, 57
4	2	Duratough Polyurethane Polyolefin	700	5-5/8	3-1/4	30 CS 420PTU**-03	23, 38, 56, 57
4	2	HD Polyolefin	700	5-5/8	3-1/4	30 CS 420HPO**-03	23, 38, 56, 57
4	2	Polyurethane Steel	700	5-5/8	3-1/4	30 CS 420PU**-03	23, 38, 56, 57
4	2	Semi-Steel	700	5-5/8	3-1/4	30 CS 420SS**-03	23, 38, 56, 57
4	2	V-Groove	700	5-5/8	3-1/4	30 CS 420VG**-03	23, 38, 56, 57
4	2	Nylon	800	5-5/8	3-1/4	30 CS 420NY**-03	23, 38, 56, 57
4	2	Solid Polyurethane	800	5-5/8	3-1/4	30 CS 420SPU**-03	23, 38, 56, 57
4	2	Polyurethane Glass-filled Nylon	800	5-5/8	3-1/4	30 CS 420MU**-03	23, 38, 56, 57
4	2	Glass-filled Nylon	800	5-5/8	3-1/4	30 CS 420MA**-03	23, 38, 56, 57
4	2	Phenolic	800	5-5/8	3-1/4	30 CS 420PH**-03	23, 38, 56, 57
4	2	Sirius HD Donut Polyurethane Aluminum	1000	5-5/8	3-1/4	30 CS 420DUA**-03	63
4	2	HD Solid Polyurethane Glass-filled Nylon	1200	5-5/8	3-1/4	30 CS 420HU**-03	23, 38, 56, 57, 63
4	2	Ductile Steel	1250	5-5/8	3-1/4	30 CS 420DS**-03	23, 38
5	2	Yoke Only	1250	-	-	30 CS 520-03	-
5	2	Thermoplastic Rubber	350	6-1/2	3-7/8	30 CS 520TPR**-03	23, 38, 56, 57
5	2	Donut Thermoplastic Rubber	350	6-1/2	3-7/8	30 CS 520DPR**-03	23, 38, 56, 57
5	2	Elastic Rubber Nylon	450	6-1/2	3-7/8	30 CS 520ERN**-03	23, 38, 56, 57
5	2	Rubber Steel	450	6-1/2	3-7/8	30 CS 520RS**-03	23, 38, 56, 57
5	2	Rubber Glass-filled Nylon	450	6-1/2	3-7/8	30 CS 520RN**-03	23, 38, 56, 57
5	2	Duratek High Tech Rubber	500	6-1/2	3-7/8	30 CS 520PPR**-03	23, 38, 56, 57

Wheel Dia.	Tread Width	Wheel Type	Load Cap.	OAH	Radius	Swivel Part #	**Bearing Options
5	2	Duratek Donut High Tech Rubber	500	6-1/2	3-7/8	30CS520DTR**03	23, 38, 56, 57
5	2	Polyurethane Polyolefin	600	6-1/2	3-7/8	30CS520PPU**03	23, 38, 56, 57
5	2	Duratough Polyurethane Polyolefin	750	6-1/2	3-7/8	30CS520PTU**03	23, 38, 56, 57
5	2	HD Polyolefin	900	6-1/2	3-7/8	30CS520HPO**03	23, 38, 56, 57
5	2	Polyurethane Steel	1000	6-1/2	3-7/8	30CS520PU**03	23, 38, 56, 57
5	2	Semi-Steel	1000	6-1/2	3-7/8	30CS520SS**03	23, 38, 56, 57
5	2	V-Groove	1000	6-1/2	3-7/8	30CS520VG**03	23, 38, 56, 57
5	2	Nylon	1000	6-1/2	3-7/8	30CS520NY**03	23, 38, 56, 57
5	2	Solid Polyurethane	1000	6-1/2	3-7/8	30CS520SPU**03	23, 38, 56, 57
5	2	Polyurethane Glass-filled Nylon	1000	6-1/2	3-7/8	30CS520MU**03	23, 38, 56, 57
5	2	Glass-filled Nylon	1000	6-1/2	3-7/8	30CS520MA**03	23, 38, 56, 57
5	2	Phenolic	1000	6-1/2	3-7/8	30CS520PH**03	23, 38, 56, 57
5	2	Sirius HD Donut Polyurethane Aluminum	1200	6-1/2	3-7/8	30CS520DUA**03	63
5	2	HD Solid Polyurethane Glass-filled Nylon	1250	6-1/2	3-7/8	30CS520HU**03	23, 38, 56, 57, 63
5	2	Ductile Steel	1250	6-1/2	3-7/8	30CS520DS**03	23, 38
6	2	Yoke Only	1250	-	-	30CS620-03	-
6	2	Thermoplastic Rubber	500	7-1/2	4-9/16	30CS620TPR**03	23, 38, 56, 57
6	2	Donut Thermoplastic Rubber	500	7-1/2	4-9/16	30CS620DPR**03	23, 38, 56, 57
6	2	Elastic Rubber Nylon	550	7-1/2	4-9/16	30CS620ERN**03	23, 38, 56, 57
6	2	Rubber Steel	550	7-1/2	4-9/16	30CS620RS**03	23, 38, 56, 57
6	2	Rubber Glass-filled Nylon	550	7-1/2	4-9/16	30CS620RN**03	23, 38, 56, 57
6	2	Duratek High Tech Rubber	600	7-1/2	4-9/16	30CS620PPR**03	23, 38, 56, 57
6	2	Duratek Donut High Tech Rubber	600	7-1/2	4-9/16	30CS620DTR**03	23, 38, 56, 57
6	2	Polyurethane Polyolefin	720	7-1/2	4-9/16	30CS620PPU**03	23, 38, 56, 57
6	2	Duratough Polyurethane Polyolefin	900	7-1/2	4-9/16	30CS620PTU**03	23, 38, 56, 57
6	2	HD Polyolefin	1000	7-1/2	4-9/16	30CS620HPO**03	23, 38, 56, 57
6	2	Polyurethane Steel	1200	7-1/2	4-9/16	30CS620PU**03	23, 38, 56, 57
6	2	Semi-Steel	1200	7-1/2	4-9/16	30CS620SS**03	23, 38, 56, 57
6	2	V-Groove	1200	7-1/2	4-9/16	30CS620VG**03	23, 38, 56, 57
6	2	Nylon	1200	7-1/2	4-9/16	30CS620NY**03	23, 38, 56, 57
6	2	Solid Polyurethane	1200	7-1/2	4-9/16	30CS620SPU**03	23, 38, 56, 57
6	2	Polyurethane Glass-filled Nylon	1200	7-1/2	4-9/16	30CS620MU**03	23, 38, 56, 57
6	2	Glass-filled Nylon	1200	7-1/2	4-9/16	30CS620MA**03	23, 38, 56, 57
6	2	Phenolic	1200	7-1/2	4-9/16	30CS620PH**03	23, 38, 56, 57
6	2	Sirius HD Polyurethane Aluminum	1250	7-1/2	4-9/16	30CS620TUA**03	63
6	2	Sirius HD Donut Polyurethane Aluminum	1250	7-1/2	4-9/16	30CS620DUA**03	63
6	2	HD Solid Polyurethane Glass-filled Nylon	1250	7-1/2	4-9/16	30CS620HU**03	23, 38, 56, 57, 63
6	2	Ductile Steel	1250	7-1/2	4-9/16	30CS620DS**03	23, 38
8	2	Yoke Only	1250	-	-	30CS820-03	-
8	2	Thermoplastic Rubber	600	9-1/2	6-1/8	30CS820TPR**03	23, 38, 56, 57
8	2	Donut Thermoplastic Rubber	600	9-1/2	6-1/8	30CS820DPR**03	23, 38, 56, 57
8	2	Elastic Rubber Nylon	600	9-1/2	6-1/8	30CS820ERN**03	23, 38, 56, 57
8	2	Rubber Steel	600	9-1/2	6-1/8	30CS820RS**03	23, 38, 56, 57
8	2	Rubber Glass-filled Nylon	600	9-1/2	6-1/8	30CS820RN**03	23, 38, 56, 57
8	2	Duratek High Tech Rubber	675	9-1/2	6-1/8	30CS820PPR**03	23, 38, 56, 57
8	2	Duratek Donut High Tech Rubber	675	9-1/2	6-1/8	30CS820DTR**03	23, 38, 56, 57
8	2	Polyurethane Polyolefin	800	9-1/2	6-1/8	30CS820PPU**03	23, 38, 56, 57
8	2	Duratough Polyurethane Polyolefin	1000	9-1/2	6-1/8	30CS820PTU**03	23, 38, 56, 57
8	2	HD Polyolefin	1200	9-1/2	6-1/8	30CS820HPO**03	23, 38, 56, 57
8	2	Polyurethane Steel	1250	9-1/2	6-1/8	30CS820PU**03	23, 38, 56, 57
8	2	Semi-Steel	1250	9-1/2	6-1/8	30CS820SS**03	23, 38, 56, 57
8	2	V-Groove	1250	9-1/2	6-1/8	30CS820VG**03	23, 38, 56, 57
8	2	Nylon	1250	9-1/2	6-1/8	30CS820NY**03	23, 38, 56, 57
8	2	Solid Polyurethane	1250	9-1/2	6-1/8	30CS820SPU**03	23, 38, 56, 57
8	2	Polyurethane Glass-filled Nylon	1250	9-1/2	6-1/8	30CS820MU**03	23, 38, 56, 57
8	2	Glass-filled Nylon	1250	9-1/2	6-1/8	30CS820MA**03	23, 38, 56, 57
8	2	Phenolic	1250	9-1/2	6-1/8	30CS820PH**03	23, 38, 56, 57
8	2	Sirius HD Polyurethane Aluminum	1250	9-1/2	6-1/8	30CS820TUA**03	63, 64
8	2	Sirius HD Donut Polyurethane Aluminum	1250	9-1/2	6-1/8	30CS820DUA**03	63, 64
8	2	HD Solid Polyurethane Glass-filled Nylon	1250	9-1/2	6-1/8	30CS820HU**03	23, 38, 56, 57, 63
8	2	Ductile Steel	1250	9-1/2	6-1/8	30CS820DS**03	23, 38

S30 Stainless Series



Quality Meets Dependability



Medium-Heavy Duty Caster



Load Capacity
1250 lbs
565 kg

Features

- 304 Stainless Steel
- Double ball bearing raceways
- 5/8" diameter nut and bolt kingpin
- 1/4" cold forged steel top plate & yoke legs
- Grease fitting in swivel raceway



Industries and Applications



Food Service



Platform Trucks



Industrial



Commercial

Size	Bolt Pattern	Attaching Bolt Dia.	Plate
4 x 4-1/2	2-5/8 x 3-5/8 to 3 x 3	3/8	03

Caster Type	Part #
Swivel	CS
Rigid	CR
Swivel/Top Lock Brake	TS
Rigid/Top Lock Brake	TR

Stainless	
Bearing Options	Part #
Roller	S23
Q34 Precision Ball	S38
1/2 I.D. Delrin	56
3/4 I.D. Delrin	57
6203 Precision Ball	S63

Options	Part #
4 Position Lock	PSL-S03

Wheel Dia.	Tread Wid.	Wheel Type	Load Cap.	OAH	Radius	Swivel Part #	**Bearing Options
4	2	Yoke only	1250	-	-	S30 CS 420-03	-
4	2	Thermoplastic Rubber	300	5-5/8	3-1/4	S30 CS 420TPR**-03	23, 38, 56, 57
4	2	Donut Thermoplastic Rubber	300	5-5/8	3-1/4	S30 CS 420DPR**-03	23, 38, 56, 57
4	2	Elastic Rubber Nylon	400	5-5/8	3-1/4	S30 CS 420ERN**-03	23, 38, 56, 57
4	2	Rubber Glass-filled Nylon	400	5-5/8	3-1/4	S30 CS 420RN**-03	23, 38, 56, 57
4	2	Duratek High Tech Rubber	450	5-5/8	3-1/4	S30 CS 420PPR**-03	23, 38, 56, 57
4	2	Duratek Donut High Tech Rubber	450	5-5/8	3-1/4	S30 CS 420DTR**-03	23, 38, 56, 57
4	2	Polyurethane Polyolefin	500	5-5/8	3-1/4	S30 CS 420PPU**-03	23, 38, 56, 57
4	2	Duratough Polyurethane Polyolefin	700	5-5/8	3-1/4	S30 CS 420PTU**-03	23, 38, 56, 57
4	2	HD Polyolefin	700	5-5/8	3-1/4	S30 CS 420HPO**-03	23, 38, 56, 57
4	2	Nylon	800	5-5/8	3-1/4	S30 CS 420NY**-03	23, 38, 56, 57
4	2	Solid Polyurethane	800	5-5/8	3-1/4	S30 CS 420SPU**-03	23, 38, 56, 57
4	2	Polyurethane Glass-filled Nylon	800	5-5/8	3-1/4	S30 CS 420MU**-03	23, 38, 56, 57
4	2	Glass-filled Nylon	800	5-5/8	3-1/4	S30 CS 420MA**-03	23, 38, 56, 57
4	2	Phenolic	800	5-5/8	3-1/4	S30 CS 420PH**-03	23, 38, 56, 57
4	2	Sirius HD Donut Polyurethane Aluminum	1000	5-5/8	3-1/4	S30 CS 420DUA**-03	63
4	2	HD Solid Polyurethane Glass-filled Nylon	1200	5-5/8	3-1/4	S30 CS 420HU**-03	23, 38, 56, 57, 63

S30 Stainless Series

Wheel Dia.	Tread Width	Wheel Type	Load Cap.	OAH	Radius	Swivel Part #	**Bearing Options
5	2	Yoke Only	1250	-	-	S30CS520-03	-
5	2	Thermoplastic Rubber	350	6-1/2	3-7/8	S30CS520TPR**-03	23, 38, 56, 57
5	2	Donut Thermoplastic Rubber	350	6-1/2	3-7/8	S30CS520DPR**-03	23, 38, 56, 57
5	2	Elastic Rubber Nylon	450	6-1/2	3-7/8	S30CS520ERN**-03	23, 38, 56, 57
5	2	Rubber Glass-filled Nylon	450	6-1/2	3-7/8	S30CS520RN**-03	23, 38, 56, 57
5	2	Duratek High Tech Rubber	500	6-1/2	3-7/8	S30CS520PPR**-03	23, 38, 56, 57
5	2	Duratek Donut High Tech Rubber	500	6-1/2	3-7/8	S30CS520DTR**-03	23, 38, 56, 57
5	2	Polyolefin	600	6-1/2	3-7/8	S30CS520PO**-03	23, 38, 56, 57
5	2	Polyurethane Polyolefin	600	6-1/2	3-7/8	S30CS520PPU**-03	23, 38, 56, 57
5	2	Duratough Polyurethane Polyolefin	750	6-1/2	3-7/8	S30CS520PTU**-03	23, 38, 56, 57
5	2	HD Polyolefin	900	6-1/2	3-7/8	S30CS520HPO**-03	23, 38, 56, 57
5	2	Nylon	1000	6-1/2	3-7/8	S30CS520NY**-03	23, 38, 56, 57
5	2	Solid Polyurethane	1000	6-1/2	3-7/8	S30CS520SPU**-03	23, 38, 56, 57
5	2	Polyurethane Glass-filled Nylon	1000	6-1/2	3-7/8	S30CS520MU**-03	23, 38, 56, 57
5	2	Glass-filled Nylon	1000	6-1/2	3-7/8	S30CS520MA**-03	23, 38, 56, 57
5	2	Phenolic	1000	6-1/2	3-7/8	S30CS520PH**-03	23, 38, 56, 57
5	2	Sirius HD Donut Polyurethane Aluminum	1200	6-1/2	3-7/8	S30CS520DUA**-03	63
5	2	HD Solid Polyurethane Glass-filled Nylon	1250	6-1/2	3-7/8	S30CS520HU**-03	23,38, 56, 57, 63
6	2	Yoke Only	1250	-	-	S30CS620-03	-
6	2	Thermoplastic Rubber	500	7-1/2	4-9/16	S30CS620TPR**-03	23, 38, 56, 57
6	2	Donut Thermoplastic Rubber	500	7-1/2	4-9/16	S30CS620DPR**-03	23, 38, 56, 57
6	2	Elastic Rubber Nylon	550	7-1/2	4-9/16	S30CS620ERN**-03	23, 38, 56, 57
6	2	Rubber Glass-filled Nylon	550	7-1/2	4-9/16	S30CS620RN**-03	23, 38, 56, 57
6	2	Duratek High Tech Rubber	600	7-1/2	4-9/16	S30CS620PPR**-03	23, 38, 56, 57
6	2	Duratek Donut High Tech Rubber	600	7-1/2	4-9/16	S30CS620DTR**-03	23, 38, 56, 57
6	2	Polyolefin	700	7-1/2	4-9/16	S30CS620PO**-03	23, 38, 56, 57
6	2	Polyurethane Polyolefin	720	7-1/2	4-9/16	S30CS620PPU**-03	23, 38, 56, 57
6	2	Duratough Polyurethane Polyolefin	900	7-1/2	4-9/16	S30CS620PTU**-03	23, 38, 56, 57
6	2	HD Polyolefin	1000	7-1/2	4-9/16	S30CS620HPO**-03	23, 38, 56, 57
6	2	Nylon	1200	7-1/2	4-9/16	S30CS620NY**-03	23, 38, 56, 57
6	2	Solid Polyurethane	1200	7-1/2	4-9/16	S30CS620SPU**-03	23, 38, 56, 57
6	2	Polyurethane Glass-filled Nylon	1200	7-1/2	4-9/16	S30CS620MU**-03	23, 38, 56, 57
6	2	Glass-filled Nylon	1200	7-1/2	4-9/16	S30CS620MA**-03	23, 38, 56, 57
6	2	Phenolic	1200	7-1/2	4-9/16	S30CS620PH**-03	23, 38, 56, 57
6	2	Sirius HD Polyurethane Aluminum	1250	7-1/2	4-9/16	S30CS620TUA**-03	63
6	2	Sirius HD Donut Polyurethane Aluminum	1250	7-1/2	4-9/16	S30CS620DUA**-03	63
6	2	HD Solid Polyurethane Glass-filled Nylon	1250	7-1/2	4-9/16	S30CS620HU**-03	23, 38, 56, 57, 63
8	2	Yoke Only	1250	-	-	S30CS820-03	-
8	2	Thermoplastic Rubber	600	9-1/2	6-1/8	S30CS820TPR**-03	23, 38, 56, 57
8	2	Donut Thermoplastic Rubber	600	9-1/2	6-1/8	S30CS820DPR**-03	23, 38, 56, 57
8	2	Elastic Rubber Nylon	600	9-1/2	6-1/8	S30CS820ERN**-03	23, 38, 56, 57
8	2	Rubber Glass-filled Nylon	600	9-1/2	6-1/8	S30CS820RN**-03	23, 38, 56, 57
8	2	Duratek High Tech Rubber	675	9-1/2	6-1/8	S30CS820PPR**-03	23, 38, 56, 57
8	2	Duratek Donut High Tech Rubber	675	9-1/2	6-1/8	S30CS820DTR**-03	23, 38, 56, 57
8	2	Polyolefin	800	9-1/2	6-1/8	S30CS820PO**-03	23, 38, 56, 57
8	2	Polyurethane Polyolefin	800	9-1/2	6-1/8	S30CS820PPU**-03	23, 38, 56, 57
8	2	Duratough Polyurethane Polyolefin	1000	9-1/2	6-1/8	S30CS820PTU**-03	23, 38, 56, 57
8	2	HD Polyolefin	1200	9-1/2	6-1/8	S30CS820HPO**-03	23, 38, 56, 57
8	2	Nylon	1250	9-1/2	6-1/8	S30CS820NY**-03	23, 38, 56, 57
8	2	Solid Polyurethane	1250	9-1/2	6-1/8	S30CS820SPU**-03	23, 38, 56, 57
8	2	Polyurethane Glass-filled Nylon	1250	9-1/2	6-1/8	S30CS820MU**-03	23, 38, 56, 57
8	2	Glass-filled Nylon	1250	9-1/2	6-1/8	S30CS820MA**-03	23, 38, 56, 57
8	2	Phenolic	1250	9-1/2	6-1/8	S30CS820PH**-03	23, 38, 56, 57
8	2	Sirius HD Polyurethane Aluminum	1250	9-1/2	6-1/8	S30CS820TUA**-03	63
8	2	Sirius HD Donut Polyurethane Aluminum	1250	9-1/2	6-1/8	S30CS820DUA**-03	63
8	2	HD Solid Polyurethane Glass-filled Nylon	1250	9-1/2	6-1/8	S30CS820HU**-03	23, 38, 56, 57, 63

34 Series



The Real MVP.
Sleek Design, Impressive Performance & All-Encompassing



Medium-Heavy Duty Caster



Load Capacity
1250 lbs
565 kg

Features

- Double ball bearing raceways
- Zinc plated finish
- 5/8" diameter permanent riveted king pin
- 1/4" cold forged steel top plate & yoke legs
- 1/2" diameter Zerk axle with lock nut

Industries and Applications



Food Service



Platform Trucks



Industrial



Commercial



Caster Type	Part #
Swivel	CS
Rigid	CR
Swivel/Total Lock Brake	TL
Swivel/Top Lock Brake	TS
Swivel/Directional Lock	DL
Rigid/Top Lock Brake	TR
Options	Part #
4 Position Lock	PSL-03

Bearing Options	Part #
Roller	23
Q34 Precision Ball	38
1/2 I.D. Delrin	56
3/4 I.D. Delrin	57
6203 Precision Ball	63
6204 Precision Ball	64

Size	Bolt Pattern	Attaching Bolt Dia.	Plate
4 x 4-1/2	2-5/8 x 3-5/8 to 3 x 3	3/8	03

Wheel Dia.	Tread Wid.	Wheel Type	Load Cap.	OAH	Radius	Swivel Part #	**Bearing Options
4	2	Yoke only	1250	-	-	34 CS 420-03	-
4	2	Thermoplastic Rubber	300	5-5/8	3-5/16	34 CS 420TPR**-03	23, 38, 56, 57
4	2	Donut Thermoplastic Rubber	300	5-5/8	3-5/16	34 CS 420DPR**-03	23, 38, 56, 57
4	2	Elastic Rubber Nylon	400	5-5/8	3-5/16	34 CS 420ERN**-03	23, 38, 56, 57
4	2	Rubber Steel	400	5-5/8	3-5/16	34 CS 420RS**-03	23, 38, 56, 57
4	2	Rubber Glass-filled Nylon	400	5-5/8	3-5/16	34 CS 420RN**-03	23, 38, 56, 57
4	2	Duratek High Tech Rubber	450	5-5/8	3-5/16	34 CS 420PPR**-03	23, 38, 56, 57
4	2	Duratek Donut High Tech Rubber	450	5-5/8	3-5/16	34 CS 420DTR**-03	23, 38, 56, 57
4	2	Polyurethane Polyolefin	500	5-5/8	3-5/16	34 CS 420PPU**-03	23, 38, 56, 57
4	2	Duratough Polyurethane Polyolefin	700	5-5/8	3-5/16	34 CS 420PTU**-03	23, 38, 56, 57
4	2	HD Polyolefin	700	5-5/8	3-5/16	34 CS 420HPO**-03	23, 38, 56, 57
4	2	Polyurethane Steel	700	5-5/8	3-5/16	34 CS 420PU**-03	23, 38, 56, 57
4	2	Semi-Steel	700	5-5/8	3-5/16	34 CS 420SS**-03	23, 38, 56, 57
4	2	V-Groove	700	5-5/8	3-5/16	34 CS 420VG**-03	23, 38, 56, 57
4	2	Nylon	800	5-5/8	3-5/16	34 CS 420NY**-03	23, 38, 56, 57
4	2	Solid Polyurethane	800	5-5/8	3-5/16	34 CS 420SPU**-03	23, 38, 56, 57
4	2	Polyurethane Glass-filled Nylon	800	5-5/8	3-5/16	34 CS 420MU**-03	23, 38, 56, 57
4	2	Glass-filled Nylon	800	5-5/8	3-5/16	34 CS 420MA**-03	23, 38, 56, 57
4	2	Phenolic	800	5-5/8	3-5/16	34 CS 420PH**-03	23, 38, 56, 57
4	2	Sirius HD Donut Polyurethane Aluminum	1000	5-5/8	3-5/16	34 CS 420DUA**-03	63
4	2	HD Solid Polyurethane Glass-filled Nylon	1200	5-5/8	3-5/16	34 CS 420HU**-03	23, 38, 56, 57, 63
4	2	Ductile Steel	1250	5-5/8	3-5/16	34 CS 420DS**-03	23, 38
5	2	Yoke Only	1250	-	-	34 CS 520-03	-
5	2	Thermoplastic Rubber	350	6-1/2	3-7/8	34 CS 520TPR**-03	23, 38, 56, 57
5	2	Donut Thermoplastic Rubber	350	6-1/2	3-7/8	34 CS 520DPR**-03	23, 38, 56, 57
5	2	Elastic Rubber Nylon	450	6-1/2	3-7/8	34 CS 520ERN**-03	23, 38, 56, 57
5	2	Rubber Steel	450	6-1/2	3-7/8	34 CS 520RS**-03	23, 38, 56, 57
5	2	Rubber Glass-filled Nylon	450	6-1/2	3-7/8	34 CS 520RN**-03	23, 38, 56, 57
5	2	Duratek High Tech Rubber	500	6-1/2	3-7/8	34 CS 520PPR**-03	23, 38, 56, 57

Wheel Dia.	Tread Width	Wheel Type	Load Cap.	OAH	Radius	Swivel Part #	**Bearing Options
5	2	Duratek Donut High Tech Rubber	500	6-1/2	3-7/8	34CS520DTR**-03	23, 38, 56, 57
5	2	Polyurethane Polyolefin	600	6-1/2	3-7/8	30CS520PPU**-03	23, 38, 56, 57
5	2	Duratough Polyurethane Polyolefin	750	6-1/2	3-7/8	34CS520PTU**-03	23, 38, 56, 57
5	2	HD Polyolefin	900	6-1/2	3-7/8	34CS520HPO**-03	23, 38, 56, 57
5	2	Polyurethane Steel	1000	6-1/2	3-7/8	34CS520PU**-03	23, 38, 56, 57
5	2	Semi-Steel	1000	6-1/2	3-7/8	34CS520SS**-03	23, 38, 56, 57
5	2	V-Groove	1000	6-1/2	3-7/8	34CS520VG**-03	23, 38, 56, 57
5	2	Nylon	1000	6-1/2	3-7/8	34CS520NY**-03	23, 38, 56, 57
5	2	Solid Polyurethane	1000	6-1/2	3-7/8	34CS520SPU**-03	23, 38, 56, 57
5	2	Polyurethane Glass-filled Nylon	1000	6-1/2	3-7/8	34CS520MU**-03	23, 38, 56, 57
5	2	Glass-filled Nylon	1000	6-1/2	3-7/8	34CS520MA**-03	23, 38, 56, 57
5	2	Phenolic	1000	6-1/2	3-7/8	34CS520PH**-03	23, 38, 56, 57
5	2	Sirius HD Donut Polyurethane Aluminum	1200	6-1/2	3-7/8	34CS520DUA**-03	63
5	2	HD Solid Polyurethane Glass-filled Nylon	1250	6-1/2	3-7/8	34CS520HU**-03	23, 38, 56, 57, 63
5	2	Ductile Steel	1250	6-1/2	3-7/8	34CS520DS**-03	23, 38
6	2	Yoke Only	1250	-	-	34CS620-03	-
6	2	Thermoplastic Rubber	500	7-1/2	4-7/8	34CS620TPR**-03	23, 38, 56, 57
6	2	Donut Thermoplastic Rubber	500	7-1/2	4-7/8	34CS620DPR**-03	23, 38, 56, 57
6	2	Elastic Rubber Nylon	550	7-1/2	4-7/8	34CS620ERN**-03	23, 38, 56, 57
6	2	Rubber Steel	550	7-1/2	4-7/8	34CS620RS**-03	23, 38, 56, 57
6	2	Rubber Glass-filled Nylon	550	7-1/2	4-7/8	34CS620RN**-03	23, 38, 56, 57
6	2	Duratek High Tech Rubber	600	7-1/2	4-7/8	34CS620PPR**-03	23, 38, 56, 57
6	2	Duratek Donut High Tech Rubber	600	7-1/2	4-7/8	34CS620DTR**-03	23, 38, 56, 57
6	2	Polyurethane Polyolefin	720	7-1/2	4-7/8	34CS620PPU**-03	23, 38, 56, 57
6	2	Duratough Polyurethane Polyolefin	900	7-1/2	4-7/8	34CS620PTU**-03	23, 38, 56, 57
6	2	HD Polyolefin	1000	7-1/2	4-7/8	34CS620HPO**-03	23, 38, 56, 57
6	2	Polyurethane Steel	1200	7-1/2	4-7/8	34CS620PU**-03	23, 38, 56, 57
6	2	Semi-Steel	1200	7-1/2	4-7/8	34CS620SS**-03	23, 38, 56, 57
6	2	V-Groove	1200	7-1/2	4-7/8	34CS620VG**-03	23, 38, 56, 57
6	2	Nylon	1200	7-1/2	4-7/8	34CS620NY**-03	23, 38, 56, 57
6	2	Solid Polyurethane	1200	7-1/2	4-7/8	34CS620SPU**-03	23, 38, 56, 57
6	2	Polyurethane Glass-filled Nylon	1200	7-1/2	4-7/8	34CS620MU**-03	23, 38, 56, 57
6	2	Glass-filled Nylon	1200	7-1/2	4-7/8	34CS620MA**-03	23, 38, 56, 57
6	2	Phenolic	1200	7-1/2	4-7/8	34CS620PH**-03	23, 38, 56, 57
6	2	Sirius HD Polyurethane Aluminum	1250	7-1/2	4-7/8	34CS620TUA**-03	63
6	2	Sirius HD Donut Polyurethane Aluminum	1250	7-1/2	4-7/8	34CS620DUA**-03	63
6	2	HD Solid Polyurethane Glass-filled Nylon	1250	7-1/2	4-7/8	34CS620HU**-03	23, 38, 56, 57, 63
6	2	Ductile Steel	1250	7-1/2	4-7/8	34CS620DS**-03	23, 38
8	2	Yoke Only	1250	-	-	34CS820-03	-
8	2	Thermoplastic Rubber	600	9-1/2	6-1/2	34CS820TPR**-03	23, 38, 56, 57
8	2	Donut Thermoplastic Rubber	600	9-1/2	6-1/2	34CS820DPR**-03	23, 38, 56, 57
8	2	Elastic Rubber Nylon	600	9-1/2	6-1/2	34CS820ERN**-03	23, 38, 56, 57
8	2	Rubber Steel	600	9-1/2	6-1/2	34CS820RS**-03	23, 38, 56, 57
8	2	Rubber Glass-filled Nylon	600	9-1/2	6-1/2	34CS820RN**-03	23, 38, 56, 57
8	2	Duratek High Tech Rubber	675	9-1/2	6-1/2	34CS820PPR**-03	23, 38, 56, 57
8	2	Duratek Donut High Tech Rubber	675	9-1/2	6-1/2	34CS820DTR**-03	23, 38, 56, 57
8	2	Polyurethane Polyolefin	800	9-1/2	6-1/2	34CS820PPU**-03	23, 38, 56, 57
8	2	Duratough Polyurethane Polyolefin	1000	9-1/2	6-1/2	34CS820PTU**-03	23, 38, 56, 57
8	2	HD Polyolefin	1200	9-1/2	6-1/2	34CS820HPO**-03	23, 38, 56, 57
8	2	Polyurethane Steel	1250	9-1/2	6-1/2	34CS820PU**-03	23, 38, 56, 57
8	2	Semi-Steel	1250	9-1/2	6-1/2	34CS820SS**-03	23, 38, 56, 57
8	2	V-Groove	1250	9-1/2	6-1/2	34CS820VG**-03	23, 38, 56, 57
8	2	Nylon	1250	9-1/2	6-1/2	34CS820NY**-03	23, 38, 56, 57
8	2	Solid Polyurethane	1250	9-1/2	6-1/2	34CS820SPU**-03	23, 38, 56, 57
8	2	Polyurethane Glass-filled Nylon	1250	9-1/2	6-1/2	34CS820MU**-03	23, 38, 56, 57
8	2	Glass-filled Nylon	1250	9-1/2	6-1/2	34CS820MA**-03	23, 38, 56, 57
8	2	Phenolic	1250	9-1/2	6-1/2	34CS820PH**-03	23, 38, 56, 57
8	2	Sirius HD Polyurethane Aluminum	1250	9-1/2	6-1/2	34CS820TUA**-03	63, 64
8	2	Sirius HD Donut Polyurethane Aluminum	1250	9-1/2	6-1/2	34CS820DUA**-03	63, 64
8	2	HD Solid Polyurethane Glass-filled Nylon	1250	9-1/2	6-1/2	34CS820HU**-03	23, 38, 56, 57, 63
8	2	Ductile Steel	1250	9-1/2	6-1/2	34CS820DS**-03	23, 38

35 Series



Industrial to the Core



Medium-Heavy Duty Caster



Load Capacity
1500 lbs
680 kg

Features

- Large double ball bearing raceways and top plate
- Zinc plated finish
- 1/4" cold forged steel top plate & yoke legs
- 3/4" Diameter heat treated kingpin and nut
- 1/2" Diameter zerk axle and lock nut
- Grease fitting in swivel raceway

Industries and Applications



Industrial



Platform Trucks



Carts



Commercial

Size	Bolt Pattern	Attaching Bolt Dia.	Plate
4-1/2 x 6-1/4	2-7/16 x 4-15/16 to 3-3/8 x 5-1/4	1/2	04

Caster Type	Part #
Swivel	CS
Rigid	CR
Swivel/Top Lock Brake	TS
Rigid/Top Lock Brake	*TR

*TR only available 4, 5, 6, 8 x 2 wide

Bearing Options	Part #
Roller	23
Q34 Precision Ball	38
1/2 I.D. Delrin	56
3/4 I.D. Delrin	57
6203 Precision Ball	63
6204 Precision Ball	64

Options	Part #
4 Position Swivel Lock	PSL-04

Wheel Dia.	Tread Width	Wheel Type	Load Cap.	OAH	Radius	Swivel Part #	**Bearing Options
4	2	Yoke Only	1500	-	-	35 CS 420-04	-
4	2	Thermoplastic Rubber	300	5-5/8	3-5/16	35 CS 420TPR**-04	23, 38, 56, 57
4	2	Donut Thermoplastic Rubber	300	5-5/8	3-5/16	35 CS 420DPR**-04	23, 38, 56, 57
4	2	Elastic Rubber Nylon	400	5-5/8	3-5/16	35 CS 420ERN**-04	23, 38, 56, 57
4	2	Rubber Steel	400	5-5/8	3-5/16	35 CS 420RS**-04	23, 38, 56, 57
4	2	Rubber Glass-filled Nylon	400	5-5/8	3-5/16	35 CS 420RN**-04	23, 38, 56, 57
4	2	Duratek High Tech Rubber	450	5-5/8	3-5/16	35 CS 420PPR**-04	23, 38, 56, 57
4	2	Duratek Donut High Tech Rubber	450	5-5/8	3-5/16	35 CS 420DTR**-04	23, 38, 56, 57
4	2	Duratough Polyurethane Polyolefin	700	5-5/8	3-5/16	35 CS 420PTU**-04	23, 38, 56, 57
4	2	HD Polyolefin	700	5-5/8	3-5/16	35 CS 420HPO**-04	23, 38, 56, 57
4	2	Polyurethane Steel	700	5-5/8	3-5/16	35 CS 420PU**-04	23, 38, 56, 57
4	2	Semi-Steel	700	5-5/8	3-5/16	35 CS 420SS**-04	23, 38, 56, 57
4	2	V-Groove	700	5-5/8	3-5/16	35 CS 420VG**-04	23, 38, 56, 57
4	2	Solid Polyurethane	800	5-5/8	3-5/16	35 CS 420SPU**-04	23, 38, 56, 57
4	2	Phenolic	800	5-5/8	3-5/16	35 CS 420PH**-04	23, 38, 56, 57
4	2	Glass-filled Nylon	800	5-5/8	3-5/16	35 CS 420MA**-04	23, 38, 56, 57
4	2	Polyurethane Glass-filled Nylon	800	5-5/8	3-5/16	35 CS 420MU**-04	23, 38, 56, 57
4	2	Sirius HD Donut Polyurethane Aluminum	1000	5-5/8	3-5/16	35 CS 420DUA**-04	63
4	2	HD Solid Polyurethane Glass-filled Nylon	1200	5-5/8	3-5/16	35 CS 420HU**-04	23, 38, 56, 57, 63
4	2	Ductile Steel	1500	5-5/8	3-5/16	35 CS 420DS**-04	23, 38

Wheel Dia.	Tread Width	Wheel Type	Load Cap.	OAH			Radius	Swivel Part #	**Bearing Options
5	2	Yoke Only	1500	-	-	-	-	35CS520-04	-
5	2	Thermoplastic Rubber	350	6-1/2	-	-	4	35CS520TPR**-04	23, 38, 56, 57
5	2	Donut Thermoplastic Rubber	350	6-1/2	-	-	4	35CS520DPR**-04	23, 38, 56, 57
5	2	Elastic Rubber Nylon	450	6-1/2	-	-	4	35CS520ERN**-04	23, 38, 56, 57
5	2	Rubber Steel	450	6-1/2	-	-	4	35CS520RS**-04	23, 38, 56, 57
5	2	Rubber Glass-filled Nylon	450	6-1/2	-	-	4	35CS520RN**-04	23, 38, 56, 57
5	2	Duratek High Tech Rubber	500	6-1/2	-	-	4	35CS520PPR**-04	23, 38, 56, 57
5	2	Duratek Donut High Tech Rubber	500	6-1/2	-	-	4	35CS520DTR**-04	23, 38, 56, 57
5	2	Duratough Polyurethane Polyolefin	750	6-1/2	-	-	4	35CS520PTU**-04	23, 38, 56, 57
5	2	HD Polyolefin	900	6-1/2	-	-	4	35CS520HPO**-04	23, 38, 56, 57
5	2	Polyurethane Steel	1000	6-1/2	-	-	4	35CS520PU**-04	23, 38, 56, 57
5	2	Semi-Steel	1000	6-1/2	-	-	4	35CS520SS**-04	23, 38, 56, 57
5	2	V-Groove	1000	6-1/2	-	-	4	35CS520VG**-04	23, 38, 56, 57
5	2	Solid Polyurethane	1000	6-1/2	-	-	4	35CS520SPU**-04	23, 38, 56, 57
5	2	Phenolic	1000	6-1/2	-	-	4	35CS520PH**-04	23, 38, 56, 57
5	2	Glass-filled Nylon	1000	6-1/2	-	-	4	35CS520MA**-04	23, 38, 56, 57
5	2	Polyurethane Glass-filled Nylon	1000	6-1/2	-	-	4	35CS520MU**-04	23, 38, 56, 57
5	2	Sirius HD Donut Polyurethane Aluminum	1200	6-1/2	-	-	4	35CS520DUA**-04	63
5	2	HD Solid Polyurethane Glass-filled Nylon	1500	6-1/2	-	-	4	35CS520HU**-04	23, 38, 56, 57, 63
5	2	Ductile Steel	1500	6-1/2	-	-	4	35CS520DS**-04	23, 38
6	2	Yoke Only	1500	-	-	-	-	35CS620-04	-
6	2	Thermoplastic Rubber	500	7-1/2	-	-	4-3/4	35CS620TPR**-04	23, 38, 56, 57
6	2	Donut Thermoplastic Rubber	500	7-1/2	-	-	4-3/4	35CS620DPR**-04	23, 38, 56, 57
6	2	Elastic Rubber Nylon	550	7-1/2	-	-	4-3/4	35CS620ERN**-04	23, 38, 56, 57
6	2	Rubber Steel	550	7-1/2	-	-	4-3/4	35CS620RS**-04	23, 38, 56, 57
6	2	Rubber Glass-filled Nylon	550	7-1/2	-	-	4-3/4	35CS620RN**-04	23, 38, 56, 57
6	2	Duratek High Tech Rubber	600	7-1/2	-	-	4-3/4	35CS620PPR**-04	23, 38, 56, 57
6	2	Duratek Donut High Tech Rubber	600	7-1/2	-	-	4-3/4	35CS620DTR**-04	23, 38, 56, 57
6	2	Polyolefin	700	7-1/2	-	-	4-3/4	35CS620PO**-04	23, 38, 56, 57
6	2	Duratough Polyurethane Polyolefin	900	7-1/2	-	-	4-3/4	35CS620PTU**-04	23, 38, 56, 57
6	2	HD Polyolefin	1000	7-1/2	-	-	4-3/4	35CS620HPO**-04	23, 38, 56, 57
6	2	Polyurethane Steel	1200	7-1/2	-	-	4-3/4	35CS620PU**-04	23, 38, 56, 57
6	2	Semi-Steel	1200	7-1/2	-	-	4-3/4	35CS620SS**-04	23, 38, 56, 57
6	2	V-Groove	1200	7-1/2	-	-	4-3/4	35CS620VG**-04	23, 38, 56, 57
6	2	Solid Polyurethane	1200	7-1/2	-	-	4-3/4	35CS620SPU**-04	23, 38, 56, 57
6	2	Glass-filled Nylon	1200	7-1/2	-	-	4-3/4	35CS620MA**-04	23, 38, 56, 57
6	2	Polyurethane Glass-filled Nylon	1200	7-1/2	-	-	4-3/4	35CS620MU**-04	23, 38, 56, 57
6	2	Phenolic	1200	7-1/2	-	-	4-3/4	35CS620PH**-04	23, 38, 56, 57
6	2	Sirius HD Polyurethane Aluminum	1500	7-1/2	-	-	4-3/4	35CS620TUA**-04	63
6	2	Sirius HD Donut Polyurethane Aluminum	1500	7-1/2	-	-	4-3/4	35CS620DUA**-04	63
6	2	HD Solid Polyurethane Glass-filled Nylon	1500	7-1/2	-	-	4-3/4	35CS620HU**-04	23, 38, 56, 57, 63
6	2	Ductile Steel	1500	7-1/2	-	-	4-3/4	35CS620DS**-04	23, 38
8	2	Yoke Only	1500	-	-	-	-	35CS820-04	-
8	2	Thermoplastic Rubber	600	A 9-1/2	B 10-1/8	5-1/2	5-1/2	35CS820TPR**-04	23, 38, 56, 57
8	2	Donut Thermoplastic Rubber	600	A 9-1/2	B 10-1/8	5-1/2	5-1/2	35CS820DPR**-04	23, 38, 56, 57
8	2	Elastic Rubber Nylon	600	A 9-1/2	B 10-1/8	5-1/2	5-1/2	35CS820ERN**-04	23, 38, 56, 57
8	2	Rubber Steel	600	A 9-1/2	B 10-1/8	5-1/2	5-1/2	35CS820RS**-04	23, 38, 56, 57
8	2	Rubber Glass-filled Nylon	600	A 9-1/2	B 10-1/8	5-1/2	5-1/2	35CS820RN**-04	23, 38, 56, 57
8	2	Duratek High Tech Rubber	675	A 9-1/2	B 10-1/8	5-1/2	5-1/2	35CS820PPR**-04	23, 38, 56, 57
8	2	Duratek Donut High Tech Rubber	675	A 9-1/2	B 10-1/8	5-1/2	5-1/2	35CS820DTR**-04	23, 38, 56, 57
8	2	Duratough Polyurethane Polyolefin	1000	A 9-1/2	B 10-1/8	5-1/2	5-1/2	35CS820PTU**-04	23, 38, 56, 57
8	2	HD Polyolefin	1200	A 9-1/2	B 10-1/8	5-1/2	5-1/2	35CS820HPO**-04	23, 38, 56, 57
8	2	Polyurethane Steel	1400	A 9-1/2	B 10-1/8	5-1/2	5-1/2	35CS820PU**-04	23, 38, 56, 57
8	2	Semi-Steel	1400	A 9-1/2	B 10-1/8	5-1/2	5-1/2	35CS820SS**-04	23, 38, 56, 57
8	2	V-Groove	1400	A 9-1/2	B 10-1/8	5-1/2	5-1/2	35CS820VG**-04	23, 38, 56, 57
8	2	Solid Polyurethane	1400	A 9-1/2	B 10-1/8	5-1/2	5-1/2	35CS820SPU**-04	23, 38, 56, 57
8	2	Phenolic	1400	A 9-1/2	B 10-1/8	5-1/2	5-1/2	35CS820PH**-04	23, 38, 56, 57
8	2	Glass-filled Nylon	1400	A 9-1/2	B 10-1/8	5-1/2	5-1/2	35CS820MA**-04	23, 38, 56, 57
8	2	Polyurethane Glass-filled Nylon	1400	A 9-1/2	B 10-1/8	5-1/2	5-1/2	35CS820MU**-04	23, 38, 56, 57
8	2	Sirius HD Polyurethane Aluminum	1500	A 9-1/2	B 10-1/8	5-1/2	5-1/2	35CS820TUA**-04	63, 64
8	2	Sirius HD Donut Polyurethane Aluminum	1500	A 9-1/2	B 10-1/8	5-1/2	5-1/2	35CS820DUA**-04	63, 64
8	2	HD Solid Polyurethane Glass-filled Nylon	1500	A 9-1/2	B 10-1/8	5-1/2	5-1/2	35CS820HU**-04	23, 38, 56, 57, 63
8	2	Ductile Steel	1500	A 9-1/2	B 10-1/8	5-1/2	5-1/2	35CS820DS**-04	23, 38

35 Series

Size	Bolt Pattern	Attaching Bolt Dia.	Plate	Caster Type			Part #	Bearing Options		Part #
4-1/2 x 6-1/4	2-7/16 x 4-15/16 to 3-3/8 x 5-1/4	1/2	04	Swivel	Rigid		CS CR	Roller	23	
				Options			Part #	Q34 Precision Ball	38	
				4 Position Swivel Lock			PSL-04	1/2 I.D. Delrin	56	
								3/4 I.D. Delrin	57	

Wheel Dia.	Tread Width	Wheel Type	Load Cap.	OAH			Radius	Swivel Part #	**Bearing Options
6	2-1/2	Yoke Only	1500	-	-	-	-	35CS625-04	-
6	2-1/2	Thermoplastic Rubber	600	7-1/2	-	-	4-3/4	35CS625TPR**-04	23, 38, 56, 57
6	2-1/2	Rubber Steel	700	7-1/2	-	-	4-3/4	35CS625RS**-04	23, 38, 56, 57
6	2-1/2	Polyurethane Steel	1500	7-1/2	-	-	4-3/4	35CS625PU**-04	23, 38, 56, 57
6	2-1/2	Semi-Steel	1500	7-1/2	-	-	4-3/4	35CS625SS**-04	23, 38, 56, 57
6	2-1/2	V-Groove	1500	7-1/2	-	-	4-3/4	35CS625VG**-04	23, 38, 56, 57
6	2-1/2	Polyurethane Glass-filled Nylon	1500	7-1/2	-	-	4-3/4	35CS625MX**-04	23, 38, 56, 57
6	2-1/2	Ductile Steel	1500	7-1/2	-	-	4-3/4	35CS625DS**-04	23, 38
8	2-1/2	Yoke Only	1500	-	-	-	-	35CS825-04	-
8	2-1/2	Thermoplastic Rubber	700	A 9-1/2	B 10-1/8	-	5-1/2	35CS825TPR**-04	23, 38, 56, 57
8	2-1/2	Rubber Steel	850	A 9-1/2	B 10-1/8	-	5-1/2	35CS825RS**-04	23, 38, 56, 57
8	2-1/2	Polyurethane Steel	1500	A 9-1/2	B 10-1/8	-	5-1/2	35CS825PU**-04	23, 38, 56, 57
8	2-1/2	Semi-Steel	1500	A 9-1/2	B 10-1/8	-	5-1/2	35CS825SS**-04	23, 38, 56, 57
8	2-1/2	V-Groove	1500	A 9-1/2	B 10-1/8	-	5-1/2	35CS825VG**-04	23, 38, 56, 57
8	2-1/2	Polyurethane Glass-filled Nylon	1500	A 9-1/2	B 10-1/8	-	5-1/2	35CS825MX**-04	23, 38, 56, 57
8	2-1/2	Ductile Steel	1500	A 9-1/2	B 10-1/8	-	5-1/2	35CS825DS**-04	23, 38
10	2-1/2	Yoke Only	1500	-	-	-	-	35CSI025-04	-
10	2-1/2	Thermoplastic Rubber	1000	11-1/2	-	-	7	35CSI025TPR**-04	23, 38, 56, 57
10	2-1/2	Rubber Steel	1000	11-1/2	-	-	7	35CSI025RS**-04	23, 38, 56, 57
10	2-1/2	Polyurethane Steel	1500	11-1/2	-	-	7	35CSI025PU**-04	23, 38, 56, 57
10	2-1/2	Semi-Steel	1500	11-1/2	-	-	7	35CSI025SS**-04	23, 38, 56, 57
10	2-1/2	V-Groove	1500	11-1/2	-	-	7	35CSI025VG**-04	23, 38, 56, 57
10	2-1/2	Polyurethane Glass-filled Nylon	1500	11-1/2	-	-	7	35CSI025MX**-04	23, 38, 56, 57
10	2-1/2	Ductile Steel	1500	11-1/2	-	-	7	35CSI025DS**-04	23, 38



Hybrid Kingpin Modular Components

The Perfect Heavy Duty Solution For Any Application.

The **46** Series **Hybrid Hollow Kingpin** yokes have been designed with strength and versatility in mind. **Four** different sized hot forged bodies combined with three cold forged top plate choices, gives you the opportunity to maintain less inventory and create the heavy duty yoke you need, when you need it.

Features

- Hot forged **ASTM 1045** steel legs and yoke base
- Heavy duty induction hardened sealed raceway
- $\frac{3}{8}$ " Diameter **HRC45** steel ball bearing raceway
- Heat treated $\frac{3}{4}$ " diameter kingpin & nut
- Double welded legs
- Endless fastening capabilities



Industries and Applications



Machinery



Automotive



Heavy Duty Equipment



Industrial

Size	Bolt Pattern	Mounting Bolt Dia.	Plate
4 x 4-1/2	2-5/8 x 3-5/8 to 3 x 3	3/8	46-03
4-1/2 x 6-1/4	2-7/16 x 4-15/16 to 3-3/8 x 5-1/4	1/2	46-04
5 x 5-1/2	4-1/8 x 4-1/2	3/8	46-05

Wheel Dia.	Tread Width	Load Cap.	OAH	Swivel Part #
4	2	2000	5-5/8	46 CS 420
5	2	2000	6-1/2	46 CS 520
6	2	2000	7-1/2	46 CS 620
8	2	2000	9-1/2	46 CS 820

Size	Type	Part #
3/4-10 x 7/16	Nut	NT1207
3/4-10 x 1-1/8	Kingpin Bolt	46-K

40 Series



High Endurance High Performance

The 40 Series are hot forged **ASTM 1045** steel kingpinless casters that each can withstand up to **2000 lbs.** Whether in machinery, military fabrication, tow-lines or automotive equipment, the 40 Series will deliver.

Features

- Hot forged **ASTM 1045** steel
- Design eliminates problems associated with kingpin failure due to severe shock loading
- Top plate and inner raceway are integrally forged construction
- Precision machined and induction hardened sealed raceway provides exceptionally smooth performance
- $\frac{3}{8}$ " Diameter HRC 45 steel ball bearings absorb thrust and load in severe environments
- Double welded legs
- Rigid arms are manufactured from 8 mm thick steel
- $\frac{1}{2}$ " Diameter Zerk axle & lock nut

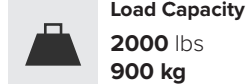

Industries and Applications



Industrial



Machinery/Fabrication
Tow-Line



Institutional



Automotive

Size	Bolt Pattern	Attaching Bolt Dia.	**Plate
4 x 4-1/2	2-5/8 x 3-5/8 to 3 x 3	3/8	03
4-1/2 x 6-1/4	2-7/16 x 4-15/16 to 3-3/8 x 5-1/4	1/2	04

Caster Type	Part #
Swivel	CS
Rigid	CR
Swivel/Top Lock Brake	TS

Bearing Options	^ Part #
Roller	23
Q34 Precision Ball	38
1/2 I.D. Delrin	56
3/4 I.D. Delrin	57
6203 Precision Ball	63
6204 Precision Ball	64

Wheel Dia.	Tread Width	Wheel Type	Load Cap.	OAH	Radius	Swivel Part #	^ Bearing Options
4	2	Yoke Only	2000	5-5/8	3-1/8	40 CS 420-**	23, 38, 56, 57
4	2	Elastic Rubber Nylon	400	5-5/8	3-1/8	40 CS 420ERN^**	23, 38, 56, 57
4	2	Duratek High Tech Rubber	450	5-5/8	3-1/8	40 CS 420PPR^**	23, 38, 56, 57
4	2	Duratough Polyurethane Polyolefin	700	5-5/8	3-1/8	40 CS 420PTU^**	23, 38, 56, 57
4	2	Polyurethane Steel	700	5-5/8	3-1/8	40 CS 420PU^**	23, 38, 56, 57
4	2	Semi-Steel	700	5-5/8	3-1/8	40 CS 420SS^**	23, 38, 56, 57
4	2	V-Groove	700	5-5/8	3-1/8	40 CS 420VG^**	23, 38, 56, 57

Wheel Dia.	Tread Width	Wheel Type	Load Cap.	OAH	Radius	Swivel Part #	^ Bearing Options
4	2	Solid Polyurethane	800	5-5/8	3-1/8	40CS420SPU^**	23, 38, 56, 57
4	2	Glass-filled Nylon	800	5-5/8	3-1/8	40CS420MA^**	23, 38, 56, 57
4	2	Polyurethane Glass-filled Nylon	800	5-5/8	3-1/8	40CS420MU^**	23, 38, 56, 57
4	2	Phenolic	800	5-5/8	3-1/8	40CS420PH^**	23, 38, 56, 57
4	2	Sirius HD Donut Polyurethane Aluminum	1000	5-5/8	3-1/8	40CS420DUA^**	63
4	2	HD Solid Polyurethane Glass-filled Nylon	1200	5-5/8	3-1/8	40CS420HU^**	23, 38, 56, 57, 63
4	2	Ductile Steel	1500	5-5/8	3-1/8	40CS420DS^**	23, 38
5	2	Yoke Only	2000	-	-	40CS520^**	-
5	2	Elastic Rubber Nylon	450	6-1/2	3-3/4	40CS520ERN^**	63
5	2	Duratek High Tech Rubber	500	6-1/2	3-3/4	40CS520PPR^**	23, 38, 56, 57
5	2	Duratough Polyurethane Polyolefin	750	6-1/2	3-3/4	40CS520PTU^**	23, 38, 56, 57
5	2	Polyurethane Steel	1000	6-1/2	3-3/4	40CS520PU^**	23, 38, 56, 57
5	2	Semi-Steel	1000	6-1/2	3-3/4	40CS520SS^**	23, 38, 56, 57
5	2	V-Groove	1000	6-1/2	3-3/4	40CS520VG^**	23, 38, 56, 57
5	2	Solid Polyurethane	1000	6-1/2	3-3/4	40CS520SPU^**	23, 38, 56, 57
5	2	Glass-filled Nylon	1000	6-1/2	3-3/4	40CS520MA^**	23, 38, 56, 57
5	2	Polyurethane Glass-filled Nylon	1000	6-1/2	3-3/4	40CS520MU^**	23, 38, 56, 57
5	2	Phenolic	1000	6-1/2	3-3/4	40CS520PH^**	23, 38, 56, 57
5	2	Sirius HD Donut Polyurethane Aluminum	1200	6-1/2	3-3/4	40CS520DUA^**	63
5	2	HD Solid Polyurethane Glass-filled Nylon	1500	6-1/2	3-3/4	40CS520HU^**	23, 38, 56, 57, 63
5	2	Ductile Steel	1500	6-1/2	3-3/4	40CS520DS^**	23, 38
6	2	Yoke Only	2000	-	-	40CS620^**	-
6	2	Elastic Rubber Nylon	550	7-1/2	4-1/2	40CS620ERN^**	63
6	2	Duratek High Tech Rubber	600	7-1/2	4-1/2	40CS620PPR^**	23, 38, 56, 57
6	2	Duratough Polyurethane Polyolefin	900	7-1/2	4-1/2	40CS620PTU^**	23, 38, 56, 57
6	2	Polyurethane Steel	1200	7-1/2	4-1/2	40CS620PU^**	23, 38, 56, 57
6	2	Semi-Steel	1200	7-1/2	4-1/2	40CS620SS^**	23, 38, 56, 57
6	2	V-Groove	1200	7-1/2	4-1/2	40CS620VG^**	23, 38, 56, 57
6	2	Solid Polyurethane	1200	7-1/2	4-1/2	40CS620SPU^**	23, 38, 56, 57
6	2	Glass-Filled Nylon	1200	7-1/2	4-1/2	40CS620MA^**	23, 38, 56, 57
6	2	Polyurethane Glass-filled Nylon	1200	7-1/2	4-1/2	40CS620MU^**	23, 38, 56, 57
6	2	Phenolic	1200	7-1/2	4-1/2	40CS620PH^**	23, 38, 56, 57
6	2	Sirius HD Polyurethane Aluminum	1500	7-1/2	4-1/2	40CS620TUA^**	63
6	2	Sirius HD Donut Polyurethane Aluminum	1500	7-1/2	4-1/2	40CS620DUA^**	63
6	2	HD Solid Polyurethane Glass-filled Nylon	1800	7-1/2	4-1/2	40CS620HU^**	23, 38, 56, 57, 63
6	2	Ductile Steel	2000	7-1/2	4-1/2	40CS620DS^**	23, 38
8	2	Yoke Only	2000	-	-	40CS820^**	-
8	2	Elastic Rubber Nylon	600	9-1/2	6-3/4	40CS820ERN^**	63
8	2	Duratek High Tech Rubber	675	9-1/2	6-3/4	40CS820PPR^**	23, 38, 56, 57
8	2	Duratough Polyurethane Polyolefin	1000	9-1/2	6-3/4	40CS820PTU^**	23, 38, 56, 57
8	2	Polyurethane Steel	1400	9-1/2	6-3/4	40CS820PU^**	23, 38, 56, 57
8	2	Semi-Steel	1400	9-1/2	6-3/4	40CS820SS^**	23, 38, 56, 57
8	2	V-Groove	1400	9-1/2	6-3/4	40CS820VG^**	23, 38, 56, 57
8	2	Solid Polyurethane	1400	9-1/2	6-3/4	40CS820SPU^**	23, 38, 56, 57
8	2	Glass-Filled Nylon	1400	9-1/2	6-3/4	40CS820MA^**	23, 38, 56, 57
8	2	Polyurethane Glass-filled Nylon	1400	9-1/2	6-3/4	40CS820MU^**	23, 38, 56, 57
8	2	Phenolic	1400	9-1/2	6-3/4	40CS820PH^**	23, 38, 56, 57
8	2	Sirius HD Polyurethane Aluminum	2000	9-1/2	6-3/4	40CS820TUA^**	63, 64
8	2	Sirius HD Donut Polyurethane Aluminum	2000	9-1/2	6-3/4	40CS820DUA^**	63, 64
8	2	HD Solid Polyurethane Glass-filled Nylon	2000	9-1/2	6-3/4	40CS820HU^**	23, 38, 56, 57, 63
8	2	Ductile Steel	2000	9-1/2	6-3/4	40CS820DS^**	23, 38

60 Series



Equipped for Heavy Duty

Power drawn or manual, the **60 Series** is always trusted.

Features

- Heavy duty hot forged top plate and yoke base manufactured from **1045** steel
- Deeply grooved double ball bearing raceways
- $\frac{3}{8}$ " Round edge steel legs, double welded
- $\frac{3}{4}$ " Diameter heat treated kingpin and nut
- $\frac{3}{4}$ " Axle and lock nut
- Grease fitting in swivel raceway
- Zinc plated finish



Heavy Duty Caster



Load Capacity
2500 lbs
1130 kg

Industries and Applications



Industrial



Heavy Duty Carts



Machinery



Food Service



Caster Type	Part #
Swivel	CS
Rigid	CR
Swivel/Face Contact Brake	FS

Bearing Options	Part #
Roller	25
Double Groove Precision	39D
6205 Precision Ball	65

Size	Bolt Pattern	Attaching Bolt Dia.	**Plate
4-1/2 x 6-1/4	2-7/16 x 4-15/16 to 3-3/8 x 5-1/4	1/2	04

Options	Part #
4 Position Swivel Lock	PSL-04

Wheel Dia.	Tread Width	Wheel Type	Load Cap.	OAH	Radius	Swivel Part #	**Bearing Options
6	3	Yoke Only	2500	-	-	60 CS 630-04	-
6	3	Rubber Steel	750	7-1/2	4-1/2	60 CS 630RS**-04	25, 39D
6	3	Duratough Polyurethane Polyolefin	1400	7-1/2	4-1/2	60 CS 630PTU**-04	25, 39D
6	3	Polyurethane Steel	2000	7-1/2	4-1/2	60 CS 630PU**-04	25, 39D
6	3	Phenolic	2000	7-1/2	4-1/2	60 CS 630PH**-04	25, 39D
6	3	HD Polyurethane Steel	2500	7-1/2	4-1/2	60 CS 630EX**-04	25, 39D
6	3	Polyurethane Glass-filled Nylon	2500	7-1/2	4-1/2	60 CS 630MX**-04	25, 39D
6	3	Semi-Steel	2500	7-1/2	4-1/2	60 CS 630SS**-04	25, 39D
6	3	Regal Polyurethane Ductile Steel	2500	7-1/2	4-1/2	60 CS 630DSU**-04	65
6	3	HD Solid Polyurethane Glass-filled Nylon	2500	7-1/2	4-1/2	60 CS 630HU**-04	65
6	3	Ductile Steel	2500	7-1/2	4-1/2	60 CS 630DS**-04	25, 39D
8	3	Yoke Only	2500	-	-	60 CS 830-04	-
8	3	Rubber Steel	900	10-1/8	6-1/4	60 CS 830RS**-04	25, 39D
8	3	Duratough Polyurethane Polyolefin	1500	10-1/8	6-1/4	60 CS 830PTU**-04	25, 39D
8	3	Polyurethane Steel	2500	10-1/8	6-1/4	60 CS 830PU**-04	25, 39D
8	3	Phenolic	2500	10-1/8	6-1/4	60 CS 830PH**-04	25, 39D
8	3	HD Polyurethane Steel	2500	10-1/8	6-1/4	60 CS 830EX**-04	25, 39D
8	3	Polyurethane Glass-filled Nylon	2500	10-1/8	6-1/4	60 CS 830MX**-04	25, 39D
8	3	Semi-Steel	2500	10-1/8	6-1/4	60 CS 830SS**-04	25, 39D
8	3	Regal Polyurethane Ductile Steel	2500	10-1/8	6-1/4	60 CS 830DSU**-04	65
8	3	HD Solid Polyurethane Glass-filled Nylon	2500	10-1/8	6-1/4	60 CS 830HU**-04	65
8	3	Ductile Steel	2500	10-1/8	6-1/4	60 CS 830DS**-04	25, 39D
10	3	Yoke Only	2500	-	-	60 CS 1030-04	-
10	3	Rubber Steel	1100	11-1/2	7-1/2	60 CS 1030RS**-04	25, 39D
10	3	Duratough Polyurethane Polyolefin	1650	11-1/2	7-1/2	60 CS 1030PTU**-04	25, 39D
10	3	Polyurethane Steel	2500	11-1/2	7-1/2	60 CS 1030PU**-04	25, 39D
10	3	Phenolic	2500	11-1/2	7-1/2	60 CS 1030PH**-04	25, 39D
10	3	HD Polyurethane Steel	2500	11-1/2	7-1/2	60 CS 1030EX**-04	25, 39D
10	3	Polyurethane Glass-filled Nylon	2500	11-1/2	7-1/2	60 CS 1030MX**-04	25, 39D
10	3	Semi-Steel	2500	11-1/2	7-1/2	60 CS 1030SS**-04	25, 39D
10	3	Regal Polyurethane Ductile Steel	2500	11-1/2	7-1/2	60 CS 1030DSU**-04	65
10	3	HD Solid Polyurethane Glass-filled Nylon	2500	11-1/2	7-1/2	60 CS 1030HU**-04	65
10	3	Ductile Steel	2500	11-1/2	7-1/2	60 CS 1030DS**-04	25, 39D
12	3	Yoke Only	2500	-	-	60 CS 1230-04	-
12	3	Thermoplastic Rubber	1200	13-1/2	9	60 CS 1230TPR**-04	25, 39D
12	3	Rubber Steel	1300	13-1/2	9	60 CS 1230RS**-04	25, 39D
12	3	Duratough Polyurethane Polyolefin	1800	13-1/2	9	60 CS 1230PTU**-04	25, 39D
12	3	Polyurethane Steel	2500	13-1/2	9	60 CS 1230PU**-04	25, 39D
12	3	Phenolic	2500	13-1/2	9	60 CS 1230PH**-04	25, 39D
12	3	HD Polyurethane Steel	2500	13-1/2	9	60 CS 1230EX**-04	25, 39D
12	3	Semi-Steel	2500	13-1/2	9	60 CS 1230SS**-04	25, 39D
12	3	Regal Polyurethane Ductile Steel	2500	13-1/2	9	60 CS 1230DSU**-04	65
12	3	HD Solid Polyurethane Glass-filled Nylon	2500	13-1/2	9	60 CS 1230HU**-04	65
12	3	Ductile Steel	2500	13-1/2	9	60 CS 1230DS**-04	25, 39D

90 Series



Steel the Show

Forged from **ASTM 1045** steel, the **90 Series** can handle any **hing** thrown at it. Made specifically for **die tables, power drawn equipment, machinery, work benches and more.**



Xtreme Heavy Duty Caster



Load Capacity
3500 lbs
1587 kg

Features

- **Heavy Duty dropped forged top plate and yolk base manufactured from ASTM 1045 steel**
- **Deeply grooved double ball bearing raceways with 1/2" hardened ball bearings**
- **3/8" Thick rounded edge steel legs, double welded**
- **1" Diameter heat treated kingpin and nut**
- **3/4" Axle and lock nut**
- **Grease fitting in swivel raceway**
- **Zinc plated finish**

Industries and Applications



Heavy Duty Machinery



Industrial



Work Benches



Automotive



Caster Type	Part #
Swivel	CS
Rigid	CR
Swivel/Face Contact Brake	FS
Options	Part #
4 Position Swivel Lock	PSL-06

Bearing Options	Part #
Roller	25
Double Groove Precision	39D
6205 Precision Ball	65

Size	Bolt Pattern	Attaching Bolt Dia.	Plate
5-1/4 x 7-1/4	3-3/8 x 5-1/4 to 4-1/8 x 6-1/8	1/2	06

Wheel Dia.	Tread Width	Wheel Type	Load Cap.	OAH	Radius	Swivel Part #	**Bearing Options
6	3	Yoke Only	3500	-	-	90 CS 630-04	-
6	3	Rubber Steel	750	8	6-1/4	90 CS 630RS**-04	25, 39D
6	3	Duratough Polyurethane Polyolefin	1400	8	6-1/4	90 CS 630PTU**-04	25, 39D
6	3	Phenolic	2000	8	6-1/4	90 CS 630PH**-04	25, 39D
6	3	Polyurethane Steel	2000	8	6-1/4	90 CS 630PU**-04	25, 39D
6	3	Semi-Steel	2500	8	6-1/4	90 CS 630SS**-04	25, 39D
6	3	Polyurethane Glass-filled Nylon	2000	8	6-1/4	90 CS 630MX**-04	25, 39D
6	3	Regal Polyurethane Ductile Steel	3000	8	6-1/4	90 CS 630DSU**-04	65
6	3	HD Solid Polyurethane Glass-filled Nylon	3000	8	6-1/4	90 CS 630HU**-04	65
6	3	HD Polyurethane Steel	3000	8	6-1/4	90 CS 630EX**-04	25, 39D
6	3	Ductile Steel	3500	8	6-1/4	90 CS 630DS**-04	25, 39D
8	3	Yoke Only	2500	-	-	90 CS 830-04	-
8	3	Rubber Steel	900	10-1/2	6-1/2	90 CS 830RS**-04	25, 39D
8	3	Duratough Polyurethane Polyolefin	1500	10-1/2	6-1/2	90 CS 830PTU**-04	25, 39D
8	3	Phenolic	2500	10-1/2	6-1/2	90 CS 830PH**-04	25, 39D
8	3	Polyurethane Steel	2500	10-1/2	6-1/2	90 CS 830PU**-04	25, 39D
8	3	Semi-Steel	2500	10-1/2	6-1/2	90 CS 830SS**-04	25, 39D
8	3	Polyurethane Glass-filled Nylon	2500	10-1/2	6-1/2	90 CS 830MX**-04	25, 39D
8	3	Regal Polyurethane Ductile Steel	3200	10-1/2	6-1/2	90 CS 830DSU**-04	65
8	3	HD Solid Polyurethane Glass-filled Nylon	3200	10-1/2	6-1/2	90 CS 830HU**-04	65
8	3	HD Polyurethane Steel	3500	10-1/2	6-1/2	90 CS 830EX**-04	25, 39D
8	3	Ductile Steel	3500	10-1/2	6-1/2	90 CS 830DS**-04	25, 39D
10	3	Yoke Only	2500	-	-	90 CS I030-04	-
10	3	Rubber Steel	1100	12-1/2	7-1/2	90 CS I030RS**-04	25, 39D
10	3	Duratough Polyurethane Polyolefin	1650	12-1/2	7-1/2	90 CS I030PTU**-04	25, 39D
10	3	Phenolic	2900	12-1/2	7-1/2	90 CS I030PH**-04	25, 39D
10	3	Polyurethane Steel	3000	12-1/2	7-1/2	90 CS I030PU**-04	25, 39D
10	3	Semi-Steel	3000	12-1/2	7-1/2	90 CS I030SS**-04	25, 39D
10	3	Polyurethane Glass-filled Nylon	3000	12-1/2	7-1/2	90 CS I030MX**-04	25, 39D
10	3	Regal Polyurethane Ductile Steel	3500	12-1/2	7-1/2	90 CS I030DSU**-04	65
10	3	HD Solid Polyurethane Glass-filled Nylon	3500	12-1/2	7-1/2	90 CS I030HU**-04	65
10	3	HD Polyurethane Steel	3500	12-1/2	7-1/2	90 CS I030EX**-04	25, 39D
10	3	Ductile Steel	3500	12-1/2	7-1/2	90 CS I030DS**-04	25, 39D
12	3	Yoke Only	2500	-	-	90 CS I230-04	-
12	3	Thermoplastic Rubber	1200	15-1/2	8-1/2	90 CS I230TPR**-04	25, 39D
12	3	Rubber Steel	1300	15-1/2	8-1/2	90 CS I230RS**-04	25, 39D
12	3	Duratough Polyurethane Polyolefin	1800	15-1/2	8-1/2	90 CS I230PTU**-04	25, 39D
12	3	Polyurethane Steel	3500	15-1/2	8-1/2	90 CS I230PU**-04	25, 39D
12	3	Phenolic	3500	15-1/2	8-1/2	90 CS I230PH**-04	25, 39D
12	3	Semi-Steel	3500	15-1/2	8-1/2	90 CS I230SS**-04	25, 39D
12	3	Regal Polyurethane Ductile Steel	3500	15-1/2	8-1/2	90 CS I230DSU**-04	65
12	3	HD Solid Polyurethane Glass-filled Nylon	3500	15-1/2	8-1/2	90 CS I230HU**-04	65
12	3	HD Polyurethane Steel	3500	15-1/2	8-1/2	90 CS I230EX**-04	25, 39D
12	3	Ductile Steel	3500	15-1/2	8-1/2	90 CS I230DS**-04	25, 39D

91 Series Kingpinless



Industrial Strength for Every Industry

No matter what industry you use it for, the **91 Series** will give you the strength you need. The top plate and inner raceway are integrally forged. Combine that with the precision machined and induction hardened sealed raceway and you'll always get exceptionally smooth performance out of the **91 Series**.



**Xtreme Heavy
Duty
Caster**



Load Capacity
**6000 lbs
2700 kg**

Industries and Applications



Machinery



Automotive



Waste



Industrial

Features

- Hot Forged **ASTM 1045** steel design eliminates problems associated with kingpin failure due to severe shock loading
- Top plate and inner raceway are integrally forged construction
- Precision machined and induction hardened sealed raceway provides exceptionally smooth performance
- ½" Diameter **HRC 45** steel ball bearings absorb shock and load in severe environments
- Grease fittings in swivel raceway
- ¾" Axle with Zerk
- Zinc plated finish



91 Series Kingpinless

Size	Bolt Pattern	Attaching Bolt Dia.	Plate	Caster Type	Part #	Bearing Options	Part #
4-1/2 x 6-1/4	2-7/16 x 4-15/16 to 3-3/8 x 5-1/4	1/2	04	Swivel	CS	Roller	25
				Rigid	CR	Double Groove Precision	39D
				Swivel/Face Contact Brake	FS	6205 Precision Ball	65
				Options	Part #		
				4 Position Swivel Lock	PSL-04		

Wheel Dia.	Tread Width	Wheel Type	Load Cap.	OAH	Radius	Swivel Part #	**Bearing Options
6	3	Yoke Only	6000	-	-	91CS630-04	-
6	3	Rubber Steel	750	7-1/2	4-5/16	91CS630RS**-04	25, 39D
6	3	Duratough Polyurethane Polyolefin	1400	7-1/2	4-5/16	91CS630PTU**-04	25, 39D
6	3	Phenolic	2000	7-1/2	4-5/16	91CS630PH**-04	25, 39D
6	3	Polyurethane Steel	2000	7-1/2	4-5/16	91CS630PU**-04	25, 39D
6	3	Polyurethane Glass-filled Nylon	2000	7-1/2	4-5/16	91CS630MX**-04	25, 39D
6	3	Semi-Steel	2500	7-1/2	4-5/16	91CS630SS**-04	25, 39D
6	3	Regal Polyurethane Ductile Steel	3000	7-1/2	4-5/16	91CS630DSU**-04	65
6	3	HD Solid Polyurethane Glass-filled Nylon	3000	7-1/2	4-5/16	91CS630HU**-04	65
6	3	HD Polyurethane Steel	3000	7-1/2	4-5/16	91CS630EX**-04	25, 39D
6	3	Ductile Steel	6000	7-1/2	4-5/16	91CS630DS**-04	25, 39D
8	3	Yoke Only	6000	-	-	91CS830-04	-
8	3	Rubber Steel	900	10-1/8	6-3/8	91CS830RS**-04	25, 39D
8	3	Duratough Polyurethane Polyolefin	1500	10-1/8	6-3/8	91CS830PTU**-04	25, 39D
8	3	Phenolic	2500	10-1/8	6-3/8	91CS830PH**-04	25, 39D
8	3	Polyurethane Steel	2500	10-1/8	6-3/8	91CS830PU**-04	25, 39D
8	3	Polyurethane Glass-filled Nylon	2500	10-1/8	6-3/8	91CS830MX**-04	25, 39D
8	3	Semi-Steel	2500	10-1/8	6-3/8	91CS830SS**-04	25, 39D
8	3	Regal Polyurethane Ductile Steel	3200	10-1/8	6-3/8	91CS830DSU**-04	65
8	3	HD Solid Polyurethane Glass-filled Nylon	3200	10-1/8	6-3/8	91CS830HU**-04	65
8	3	HD Polyurethane Steel	3500	10-1/8	6-3/8	91CS830EX**-04	25, 39D
8	3	Ductile Steel	6000	10-1/8	6-3/8	91CS830DS**-04	25, 39D
10	3	Yoke Only	6000	-	-	91CSI030-04	-
10	3	Rubber Steel	1100	11-1/2	7-9/16	91CSI030RS**-04	25, 39D
10	3	Duratough Polyurethane Polyolefin	1650	11-1/2	7-9/16	91CSI030PTU**-04	25, 39D
10	3	Phenolic	2900	11-1/2	7-9/16	91CSI030PH**-04	25, 39D
10	3	Polyurethane Steel	3000	11-1/2	7-9/16	91CSI030PU**-04	25, 39D
10	3	Polyurethane Glass-Filled Nylon	3000	11-1/2	7-9/16	91CSI030MX**-04	25, 39D
10	3	Semi-Steel	3000	11-1/2	7-9/16	91CSI030SS**-04	25, 39D
10	3	Regal Polyurethane Ductile Steel	3500	11-1/2	7-9/16	91CSI030DSU**-04	65
10	3	HD Solid Polyurethane Glass-filled Nylon	3500	11-1/2	7-9/16	91CSI030HU**-04	65
10	3	HD Polyurethane Steel	4000	11-1/2	7-9/16	91CSI030EX**-04	25, 39D
10	3	Ductile Steel	6000	11-1/2	7-9/16	91CSI030DS**-04	25, 39D
12	3	Yoke Only	6000	-	-	91CSI230-04	-
12	3	Thermoplastic Rubber	1200	13-1/2	9-1/16	91CSI230TPR**-04	25, 39D
12	3	Rubber Steel	1300	13-1/2	9-1/16	91CSI230RS**-04	25, 39D
12	3	Duratough Polyurethane Polyolefin	1800	13-1/2	9-1/16	91CSI230PTU**-04	25, 39D
12	3	Phenolic	3500	13-1/2	9-1/16	91CSI230PH**-04	25, 39D
12	3	Polyurethane Steel	3500	13-1/2	9-1/16	91CSI230PU**-04	25, 39D
12	3	Semi-Steel	3500	13-1/2	9-1/16	91CSI230SS**-04	25, 39D
12	3	Regal Polyurethane Ductile Steel	3800	13-1/2	9-1/16	91CSI230DSU**-04	65
12	3	HD Solid Polyurethane Glass-filled Nylon	3800	13-1/2	9-1/16	91CSI230HU**-04	65
12	3	HD Polyurethane Steel	4500	13-1/2	9-1/16	91CSI230EX**-04	25, 39D
12	3	Ductile Steel	6000	13-1/2	9-1/16	91CSI230DS**-04	25, 39D

92 Series Kingpinless



The Heaviest Hitter



The **92 Series** is the **heaviest duty** caster we **mak**, and we **make** it to last. **With our 3 year warranty** you know we aren't **kidding** around. From **industrial** to **mechanical**, the **92 Series** **WILL** get it done



Xtreme Heavy Duty Caster



Load Capacity
6000 lbs
2700 kg

Industries and Applications



Machinery



Automotive



Waste



Industrial

Features

- **Hot Forged ASTM 1045 steel design** eliminates problems associated with **kingpin failure** due to severe **shock loading**
- **Top plate and inner raceway** are **integrally forged construction**
- **Precision machined and induction hardened sealed raceway** provides **exceptionally smooth performance**
- **½" Diameter HRC 45 steel ball bearings** absorb **thrust and load** in severe environments
- **Grease fitting** in swivel raceway
- **¾" Axle with zerk**
- **Zinc plated finish**



92 Kingpinless Series

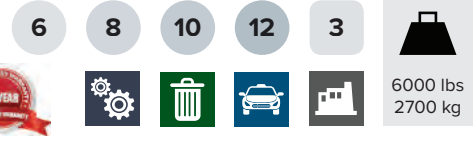

Caster Type	Part #
Swivel	CS
Rigid	CR
Swivel/Face Contact Brake	FS
Options	Part #
4 Position Swivel Lock	PSL-06

Bearing Options	Part #
Roller	25
Double Groove Precision	39D
6205 Precision Ball	65

Size	Bolt Pattern	Attaching Bolt Dia.	Plate
5-1/4 x 7-1/4	3-3/8 x 5-1/4 to 4-1/8 x 6-1/8	1/2	06

Wheel Dia.	Tread Width	Wheel Type	Load Cap.	OAH	Radius	Swivel Part #	**Bearing Options
6	3	Yoke Only	6000	-	-	92CS630-06	-
6	3	Rubber Steel	750	8	4-3/4	92CS630RS**-06	25, 39D
6	3	Duratough Polyurethane Polyolefin	1400	8	4-3/4	92CS630PTU**-06	25, 39D
6	3	Phenolic	2000	8	4-3/4	92CS630PH**-06	25, 39D
6	3	Polyurethane Steel	2000	8	4-3/4	92CS630PU**-06	25, 39D
6	3	Polyurethane Glass-filled Nylon	2000	8	4-3/4	92CS630MX**-06	25, 39D
6	3	Semi-Steel	2500	8	4-3/4	92CS630SS**-06	25, 39D
6	3	Regal Polyurethane Ductile Steel	3000	8	4-3/4	92CS630DSU**-06	65
6	3	HD Solid Polyurethane Glass-filled Nylon	3000	8	4-3/4	92CS630HU**-06	65
6	3	HD Polyurethane Steel	3000	8	4-3/4	92CS630EX**-06	25, 39D
6	3	Ductile Steel	6000	8	4-3/4	92CS630DS**-06	25, 39D
8	3	Yoke Only	6000	-	-	92CS830-06	-
8	3	Rubber Steel	900	10-1/2	6-1/2	92CS830RS**-06	25, 39D
8	3	Duratough Polyurethane Polyolefin	1500	10-1/2	6-1/2	92CS830PTU**-06	25, 39D
8	3	Phenolic	2500	10-1/2	6-1/2	92CS830PH**-06	25, 39D
8	3	Polyurethane Steel	2500	10-1/2	6-1/2	92CS830PU**-06	25, 39D
8	3	Polyurethane Glass-filled Nylon	2500	10-1/2	6-1/2	92CS830MX**-06	25, 39D
8	3	Semi-Steel	2500	10-1/2	6-1/2	92CS830SS**-06	25, 39D
8	3	Regal Polyurethane Ductile Steel	3200	10-1/2	6-1/2	92CS830DSU**-06	65
8	3	HD Solid Polyurethane Glass-filled Nylon	3200	10-1/2	6-1/2	92CS830HU**-06	65
8	3	HD Polyurethane Steel	3500	10-1/2	6-1/2	92CS830EX**-06	25, 39D
8	3	Ductile Steel	6000	10-1/2	6-1/2	92CS830DS**-06	25, 39D
10	3	Yoke Only	6000	-	-	92CS1030-06	-
10	3	Rubber Steel	1100	12-1/2	8-1/32	92CS1030RS**-06	25, 39D
10	3	Duratough Polyurethane Polyolefin	1650	12-1/2	8-1/32	92CS1030PTU**-06	25, 39D
10	3	Phenolic	2900	12-1/2	8-1/32	92CS1030PH**-06	25, 39D
10	3	Polyurethane Steel	3000	12-1/2	8-1/32	92CS1030PU**-06	25, 39D
10	3	Polyurethane Glass-Filled Nylon	3000	12-1/2	8-1/32	92CS1030MX**-06	25, 39D
10	3	Semi-Steel	3000	12-1/2	8-1/32	92CS1030SS**-06	25, 39D
10	3	Regal Polyurethane Ductile Steel	3500	12-1/2	8-1/32	92CS1030DSU**-06	65
10	3	HD Solid Polyurethane Glass-filled Nylon	3500	12-1/2	8-1/32	92CS1030HU**-06	65
10	3	HD Polyurethane Steel	4000	12-1/2	8-1/32	92CS1030EX**-06	25, 39D
10	3	Ductile Steel	6000	12-1/2	8-1/32	92CS1030DS**-06	25, 39D
12	3	Yoke Only	6000	-	-	92CS1230-06	-
12	3	Thermoplastic Rubber	1200	15-1/2	10-1/32	92CS1230TPR**-06	25, 39D
12	3	Rubber Steel	1300	15-1/2	10-1/32	92CS1230RS**-06	25, 39D
12	3	Duratough Polyurethane Polyolefin	1800	15-1/2	10-1/32	92CS1230PTU**-06	25, 39D
12	3	Phenolic	3500	15-1/2	10-1/32	92CS1230PH**-06	25, 39D
12	3	Polyurethane Steel	3500	15-1/2	10-1/32	92CS1230PU**-06	25, 39D
12	3	Semi-Steel	3000	15-1/2	10-1/32	92CS1230SS**-06	25, 39D
12	3	Regal Polyurethane Ductile Steel	3800	15-1/2	10-1/32	92CS1230DSU**-06	65
12	3	HD Solid Polyurethane Glass-filled Nylon	3800	15-1/2	10-1/32	92CS1230HU**-06	65
12	3	HD Polyurethane Steel	4500	15-1/2	10-1/32	92CS1230EX**-06	25, 39D
12	3	Ductile Steel	6000	15-1/2	10-1/32	92CS1230DS**-06	25, 39D

100 Series Pneumatic Flat Free Casters



As Smooth as it Gets

The 100 Series casters provide smooth and easy movement on all types of terrain



Pneumatic/
Flat-Free
Casters



Load Capacity
300 lbs
136 kg

Features

- Double ball bearing swivel raceways
- Zinc plated finish
- Top plate and yole legs manufactured from 1/4" cold forged steel
- 5/8" Riveted king pin
- 1/2" Diameter axle and lock nut
- Shock absorbing
- Grease fitting in swivel raceway
- Quiet rolling and easy moving

Industries and Applications



Platform Trucks



Commercial



Institutional



Lawn and Garden

Caster Type	Part #
Swivel	CS
Rigid	CR
Swivel/Top Lock Brake (6" & 8" only)	TS

Options	Part #	Bearing Options	Part #
4 Position Swivel Lock	PSL-03	1/2 Flanged Ball	44

Size	Bolt Pattern	Plate
4 x 4-1/2	2-5/8 x 3-5/8 to 3 x 3	03

Wheel Dia.	Tread Width	Wheel Type	Load Cap.	OAH	Radius	Swivel Part #
6	2	Flat-Free	250	7-1/2	4-1/2	100 CS 620FF44B-03
8	3	Flat-Free	275	9-3/4	6-1/2	100 CS 830FF44B-03
8	3	Pneumatic (280/250-4)	250	9-3/4	6-1/2	100 CS 830FP44B-03
10	3-1/2	Flat-Free	300	13	7-1/4	100 CS 1035FF44B-03
10	3-1/2	Pneumatic (410/350-4)	300	13	7-1/4	100 CS 1035FP44B-03

WHEELS



Wheel Numbering System

5

14

PPU

34

K

Wheel Dia.		Wheel Width		Wheel Type		Bearing Type		Wheel Color	
#	Diameter	#	Width	#	Description	#	I.D.	#	Description
2	2	78	7/8	PPR	Duratek High Tech Rubber	1*	Annular Ball	A	Black Gray
25	2-1/2	10	1	DTR	Duratek Donut High Tech Rubber	10	5/16	B	Black
3	3	14	1-1/4	FX	Formula XS Rubber	11	3/8	C	Green Gray
34	3-1/4	15	1-1/2	TPR	Thermoplastic Rubber	12	1/2	D	Red Gray
35	3-1/2	113	1-13/16	DPR	Donut Thermoplastic Rubber	2*	Roller	E	White
4	4	20	2	HR	Hard Rubber	21	1/2	F	Maroon Black
5	5	25	2-1/2	SR	Soft Rubber	23	3/4	G	Green Black
6	6	275	2-3/4	RS	Rubber Steel	25	1	H	Gray Black
8	8	30	3	ERN	Elastic Rubber Nylon	26	1-1/4	J	Maroon Gray
10	10	35	3-1/2	RN	Rubber Glass-filled Nylon	27	1-1/2	K	Red Black
12	12	40	4	PO	Polyolefin	3*	Precision Ball	L	Blue
		50	5	DPO	Donut Polyolefin	31	5/16	M	Yellow
				HPO	Heavy Duty Polyolefin	34	3/8 Full Thread Guard	N	Green
				NY	Nylon	35	3/8 Small Thread Guard	O	Orange Red Gray
				PTU	Duratough Polyurethane Polyolefin	38	1/2	P	Purple Gray
				DTU	Duratough Donut Polyurethane Polyolefin	39R	3/4 Single Groove	Q	Purple Beige
				PPU	Polyurethane Polyolefin	39D	3/4 Double Groove	R	Red
				TUA	Sirius Polyurethane Aluminum	40D	1 Double Groove	S	Silver
				DUA	Sirius Donut Polyurethane Aluminum	62	6202 (3/8 Bushing)	T	Brown
				DSU	Regal Polyurethane Ductile Steel	63	6203 (1/2 Bushing)	U	Blue Black
				SPU	Solid Polyurethane	64	6204 (5/8 Bushing)	V	Red Silver
				HU	HD Solid Polyurethane Glass-filled Nylon	65	6205 (3/4 Bushing)	W	Black White
				MU	Polyurethane Glass-filled Nylon (2 inch wide)	4*	Flanged Ball	X	Gray Gray
				MX	Polyurethane Glass-filled Nylon (2-1/2 & 3 inch wide)	41	5/16	Y	Gray Beige
				PU	Polyurethane Steel	42	3/8	Z	Blue Gray
				EX	HD Polyurethane Steel	44	1/2		
				PH	Phenolic	45	5/8		
				MA	Glass-filled Nylon	46	3/4		
				TPH	Hi-Temp Phenolic	5*	Delrin		
				TMA	Hi-Temp Glass-filled Nylon	56	1/2		
				SS	Semi-Steel	57	3/4		
				VG	Steel V-Groove	8*	Plain Bore		
				DS	Ductile Steel	80	1/4		
				DVG	Ductile Steel V-Groove	81	5/16		
				FF	Flat Free	82	3/8		
				FP	Full Pneumatic	83	1/2		
				SNP	Semi-Pneumatic	84	1-3/16		
						85	1-3/8		
						86	1-15/16		
						87	2-7/16		
						88	3/4		
						89	7/8		

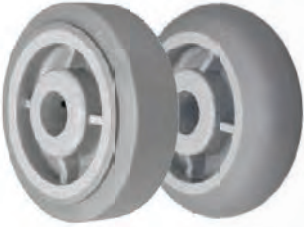

PPR & DTR
page 46



FX
page 46

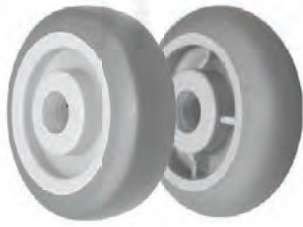

TPR & DPR
page 47



HR & SR
page 48



RS
page 48



ERN
page 49



RN
page 49



PO & DPO
page 50



HPO
page 50



NY
page 51



PTU & DTU
page 52



PPU
page 53



TUA & DUA
page 54



DSU
page 54



SPU
page 55

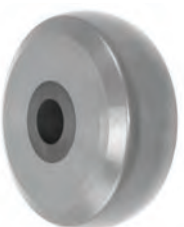

HU
page 55



MU & MX
page 56



PU & EX
page 57



PH
page 58



MA
page 58



Hi - Temp
page 59



SS & VG
page 60-61



DS & DVG
page 60-61





FF, FP & SNP
page 62

PPR | DTR | FX

PPR | DTR Duratek High Tech Rubber



	
675 lbs 305 kg	180° F -45° F

Features



- **65 Durometer Shore (A)**
- **High-grade thermoplastic elastomer mechanically bonded to polyolefin core**
- **Resists most solvents, oil, grease and water**
- **Non-marking, quiet and smooth operation**
- **Great for factory institutional and food service environments**

Bearing Options	Part #
3/8 Annular	11
3/4 Roller	23
1/2 Q34 Precision Ball	38
1/2 Delrin	56
3/4 Delrin	57

Wheel Dia.	Tread Width	Hub Length	Load Cap.	Plain Bore Dia.	Flat Tread #	Donut Tread #	*Plain Bore	*Roller	*Precision Ball	*Annular Ball	*Delrin
2-1/2	1-1/4	1-9/16	150	-	2514PPR35X	--	-	-	35	-	-
3	1-1/4	1-1/2	225	7/8	314PPR*	--	89	-	-	11	56
3-1/2	1-1/4	1-1/2	250	7/8	3514PPR*	--	89	-	-	11	56
4	1-1/4	1-1/2	300	7/8	414PPR*	--	89	-	-	11	56
4	1-1/2	1-5/8	400	1-3/16	415PPR*	--	84	23	38	-	56, 57
4	2	2-3/16	450	1-3/16	420PPR*	420DTR*	84	23	38	-	56, 57
5	1-1/4	1-1/2	325	7/8	514PPR*	--	89	-	-	11	56
5	1-1/2	1-5/8	450	1-3/16	515PPR*	--	84	23	38	-	56, 57
5	2	2-3/16	500	1-3/16	520PPR*	520DTR*	84	23	38	-	56, 57
6	1-1/2	1-5/8	500	1-3/16	615PPR*	--	84	23	38	-	56, 57
6	2	2-3/16	600	1-3/16	620PPR*	620DTR*	84	23	38	-	56, 57
8	2	2-3/16	675	1-3/16	820PPR*	820DTR*	84	23	38	-	56, 57

FX Formula XS Rubber



	
325 lbs 145 kg	180° F -45° F

Features

- **65 Durometer Shore (A)**
- **Thermoplastic rubber bonded to polyolefin core**
- **Non-marking, quiet and smooth operation**
- **Great for furniture dollies, factory institutional and food service environments**

Wheel Dia.	Tread Width	Hub Length	Load Cap.	Part #	*Precision Ball
3	1-1/4	1-1/2	225	314FX35X	35
3-1/2	1-1/4	1-1/2	230	3514FX35X	35
4	1-1/4	1-1/2	300	414FX*	34, 35
5	1-1/4	1-1/2	325	514FX*	34, 35

Bearing Options	Part #
3/8 Precision Full Thread Guard	34
3/8 Precision Small Thread Guard	35

TPR | DPR Thermoplastic Rubber

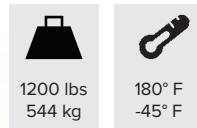
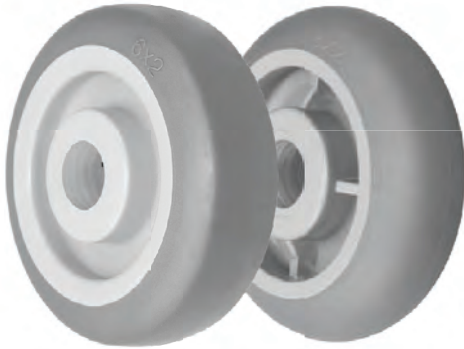

Features

- Non-marking thermoplastic rubber tread on polyolefin core
- 70 Durometer Shore (A)
- Resists most solvents, oil, grease & water
- Light weight, smooth rolling & quiet

Wheel Dia.	Tread Width	Hub Length	Load Cap.	Plain Bore Dia.	Flat Tread #	Donut Tread #	*Plain Bore	*Roller	*Precision Ball	*Flanged Ball	*Delrin
2	7/8	1	90	1/4	278TPR*	--	80	-	-	-	-
2-1/2	7/8	1	90	1/4	2578TPR*	--	80	-	-	-	-
3	7/8	1	90	1/4	378TPR*	--	80	-	-	-	-
3	1	1-1/8	100	5/16	310TPR*	--	81	-	-	-	-
3	1-1/4	1-9/16	210	-	--	314DPR*	-	-	35	-	-
3-1/2	1-1/4	1-9/16	230	-	--	3514DPR*	-	-	35	-	-
4	1	1-1/8	125	5/16	410TPR*	--	81	-	-	-	-
4	1-1/4	1-9/16	250	-	--	414DPR*	-	-	35	-	-
4	2	2-3/16	300	1-3/16	420TPR*	420DPR*	84	23	38	-	56, 57
5	1	1-1/8	130	5/16	510TPR*	--	81	-	-	-	-
5	1-1/4	1-9/16	300	-	514TPR*	514DPR*	-	-	34, 35	-	-
5	2	2-3/16	350	1-3/16	520TPR*	520DPR*	84	23	38	-	56, 57
6	1-1/4	1-9/16	325	-	--	614DPR*	-	-	35	-	-
6	2	2-3/16	500	1-3/16	620TPR*	620DPR*	84	23	38	-	56, 57
6	2-1/2	2-3/4	600	1-3/16, 1-15/16	625TPR*	--	84, 86	23, 25	38	-	-
8	1-1/2	2	400	-	815TPR*	--	-	-	-	44, 45, 46	-
8	2	2-3/16	600	1-3/16	820TPR*	820DPR*	84	23	38	-	56, 57
8	2-1/2	2-3/4	700	1-3/16, 1-15/16	825TPR*	--	84, 86	23, 25	38	-	56, 57
10	1-1/2	2	600	-	1015TPR*	--	-	-	-	44, 45, 46	-
10	2-1/2	2-3/4	1000	1-3/16, 1-15/16	1025TPR*	--	84, 86	23, 25	38	-	56, 57
12	3	3-1/4	1200	1-15/16	1230TPR*	-	86	25	39D	-	-

Bearing Options	Part #
3/8 Annular	11
3/4 Roller	23
3/8 Precision Full Thread Guard	34
3/8 Precision Small Thread Guard	35
1/2 Q34 Precision Ball	38
3/4 Double Groove Precision	39D
1/2 Delrin	56
3/4 Delrin	57

HR | SR | RS

HR | SR Hard Rubber & Soft Rubber



Features

- HR - 60 (±5) Durometer Shore (D)
- HR - High impact molded hard rubber
- SR - 80 (±5) Durometer Shore (A)
- SR - Soft rubber tread molded to hard rubber core for shock absorption and floor protection

Wheel Dia.	Tread Width	Hub Length	Plain Bore Dia.	Load Cap.	Hard Rubber HR		Soft Rubber SR	
					Part #	Load Cap.	Part #	
2	7/8	1	1/4	100	278HR80B	90	278SR80B	
2-1/2	7/8	1	1/4	100	2578HR80B	90	2578SR80B	
3	7/8	1	1/4	100	378HR80B	90	378SR80B	
3	1	1-1/4	5/16	125	310HR81B	100	310SR81B	
3	1-1/4	1-9/16	3/8	275	314HR82B	175	314SR82B	
4	1	1-1/4	5/16	140	410HR81B	125	410SR81B	
4	1-1/4	1-9/16	3/8	300	414HR82B	220	414SR82B	
5	1	1-1/4	5/16	145	510HR81B	130	510SR81B	
5	1-1/4	1-9/16	3/8	325	514HR82B	250	514SR82B	

RS Rubber on Steel

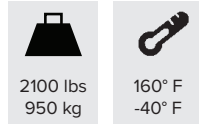

Features



- 70 Durometer Shore (A)
- Cushion rubber tread vulcanized to steel center
- Excellent floor and load protection
- Easy rolling, shock absorption and quiet operation
- Zerk fitting

Bearing Options	Part #
3/4 Roller	23
1 Roller	25
1/2 Q34 Precision Ball	38
3/4 Double Groove Precision	39D

Wheel Dia.	Tread Width	Hub Length	Load Cap.	Plain Bore Dia.	Part #	**Plain Bore	**Roller	** Precision Ball
4	2	2-3/16	400	1-3/16	420RS**B	84	23	38
5	2	2-3/16	450	1-3/16	520RS**B	84	23	38
6	2	2-3/16	550	1-3/16	620RS**B	84	23	38
6	2-1/2	2-3/4	700	1-15/16	625RS**B	86	25	-
6	3	3-1/4	750	1-15/16	630RS**B	86	25	39D
8	2	2-3/16	600	1-3/16	820RS**B	84	23	38
8	2-1/2	2-3/4	850	1-3/16, 1-15/16	825RS**B	84, 86	23, 25	-
8	3	3-1/4	900	1-15/16	830RS**B	86	25	39D
10	2	2-3/16	720	1-3/16	1020RS**B	84	23	38
10	2-1/2	2-3/4	1000	1-3/16, 1-15/16	1025RS**B	84, 86	23, 25	-
10	3	3-1/4	1100	1-15/16	1030RS**B	86	25	39D
12	2-1/2	2-3/4	1200	1-15/16	1225RS**B	86	25	-
12	3	3-1/4	1300	1-15/16	1230RS**B	86	25	39D
12	5	5-1/4	2100	2-7/16	1250RS**B	87	-	-

ERN Elastic Rubber on Glass-filled Nylon



 600 lbs 270 kg	 160° F -40° F
--	---

Features

- **70-75 Durometer Shore (A)**
- Elastic rubber molded to nylon center
- **6203 precision ball bearings**
- Easy rolling, impact resistant and shock absorbing
- 1/2" Inside diameter top hat bushings available T suffix

Wheel Dia.	Tread Width	Hub Length	Load Cap.	Part #
4	1-1/4	1-9/16	300	414ERN21U
4	2	2-3/16	400	420ERN63U
5	2	2-3/16	450	520ERN63U
6	2	2-3/16	550	620ERN63U
8	2	2-3/16	600	820ERN63U

Bearing Options	Part #
1/2 Roller	21
6203 Precision Ball	63

RN Rubber on Glass-filled Nylon



 600 lbs 270 kg	 160° F -30° F
--	---

Features

- **70 Durometer Shore (A)**
- No rust or core decay
- Greater impact absorption than steel core
- Easy rolling, shock absorption and quiet operation

Wheel Dia.	Tread Width	Hub Length	Load Cap.	Part #	**Bearing Options
4	2	2-3/16	400	420RN23B	23
5	2	2-3/16	450	520RN23B	23
6	2	2-3/16	550	620RN23B	23
8	2	2-3/16	600	820RN23B	23
10	2-1/2	2-3/4	1000	1025RN**B	23, 25, 84, 86
12	2-1/2	2-3/4	1200	1225RN**B	25, 86

Bearing Options	Part #
3/4 Roller	23
1 Roller	25

PO | DPO | HPO

PO | DPO Polyolefin & Donut Tread Polyolefin





800 lbs
360 kg



180° F
-45° F

Features

- **70 (±5) Durometer Shore (D)**
- **Economic and light weight injection molded wheel**
- **Resistant to high shock, impact, chemicals and abrasion**
- **Resists water**

Wheel Dia.	Tread Width	Hub Length	Load Cap.	Plain Bore Dia.	Black Part #	White Part #
2	7/8	1	100	1/4	278PO80B	-
2-1/2	7/8	1	100	1/4	2578PO80B	-
3	7/8	1	100	1/4	378PO80B	-
3	1	1-1/8	125	5/16	310PO81B	-
3	1-1/4	1-9/16	250	3/8	314PO82B	-
3	1-1/4	1-9/16	300	1/2	-	314DPO83E
3-1/2	1-1/4	1-9/16	325	3/8	3514DPO82B	-
4	1	1-1/8	140	5/16	410PO81B	-
4	1-1/4	1-9/16	300	3/8	414PO82B	-
4	1-1/4	1-9/16	350	3/8, 1/2	414DPO82B	414DPO83E
5	1	1-1/8	145	5/16	510PO81B	-
5	1-1/4	1-9/16	325	3/8	514PO82B	-
5	1-1/4	1-9/16	375	3/8, 1/2	514DPO82B	514DPO83E
5	2	2-3/16	600	3/4	520PO88B	520PO88E
6	1-1/2	1-5/8	650	1/2	615PO83B	-
6	2	2-3/16	700	3/4	-	620PO88E
8	2	2-3/16	800	3/4	-	820PO88E

HPO Heavy Duty Polyolefin





1200 lbs
540 kg



180° F
-45° F

Features

- **70 (±5) Durometer Shore (D)**
- **Heavy duty injection molded wheel**
- **Resistant to high shock, impact, chemicals and abrasion**
- **Resists water**
- **Offers superior strength compared to standard polyolefin wheels**

Bearing Options	Part #
3/4 Roller	23
1/2 Q34 Precision Ball	38
1/2 Delrin	56
3/4 Delrin	57

Wheel Dia.	Tread Width	Hub Length	Load Cap.	Plain Bore Dia.	Part #	*Plain Bore	*Roller	*Precision Ball	*Delrin
3	1-13/16	2	500	1/2, 1-3/16	3113HPO*	83, 84	23	38	56, 57
3	1-1/4	1-9/16	300	3/8	314HPO82B	82	-	-	-
4	2	2-3/16	700	1-3/16	420HPO*	84	23	38	56, 57
5	1-1/2	1-5/8	385	1/2	515HPO83E	83	-	-	-
5	2	2-3/16	900	1-3/16	520HPO*	84	23	38	56, 57
6	1-1/2	1-5/8	400	1/2	615HPO83E	83	-	-	-
6	2	2-3/16	1000	1-3/16	620HPO*	84	23	38	56, 57
8	2	2-3/16	1200	1-3/16	820HPO*	84	23	38	56, 57

NY Nylon

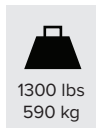

Features

- Excellent wheel for washdown applications
- Highly resistant to chemicals and solvents
- Non-marking

Bearing Options	Part #
3/4 Roller	23
1/2 Q34 Precision Ball	38
1/2 Delrin	56
3/4 Delrin	57

Wheel Dia.	Tread Width	Hub Length	Load Cap.	Plain Bore Dia.	Part #	*Plain Bore	*Roller	*Precision Ball	*Delrin
3	1-1/4	1-9/16	300	3/8	314NY82E	82	-	-	-
4	1-1/4	1-9/16	350	3/8	414NY82E	82	-	-	-
4	2	2-3/16	800	1-3/16	420NY*E	84	23	38	56, 57
5	1-1/4	1-9/16	500	3/8	514NY82E	82	-	-	-
5	2	2-3/16	1000	1-3/16	520NY*E	84	23	38	56, 57
6	2	2-3/16	1200	1-3/16	620NY*E	84	23	38	56, 57
8	2	2-3/16	1300	1-3/16	820NY*E	84	23	38	56, 57

PTU | DTU

PTU | DTU DURATOUGH Hi-Tech Polyurethane on Polyolefin





1800 lbs
815 kg



180° F
-45° F

Features

- Liquid cast flow through **100% polyurethane tread**
- **90-95 Durometer Shore (A) polyurethane tread mechanically bonded to polyolefin core**
- **High capacity and lightweight**
- Resists oil, grease, water, and most solvents
- Non-marking, smooth rolling and quiet
- **Multi-year tread durability**
- Various colors available

Wheel Dia.	Tread Width	Hub Length	Load Cap.	Flat Tread #	Donut Tread #	*Plain Bore	*Roller	*Precision Ball	*Annular Ball	Delrin
3	1-1/4	1-9/16	275	314PTU*	--	89	-	-	11	56
3-1/2	1-1/4	1-9/16	300	3514PTU*	--	89	-	-	11	56
4	1-1/4	1-9/16	325	414PTU*	--	89	-	-	11	56
4	2	2-3/16	700	420PTU*	420DTU*	84	23	38	-	56, 57
5	1-1/4	1-9/16	350	514PTU*	--	89	-	-	11	56
5	2	2-3/16	750	520PTU*	520DTU*	84	23	38	-	56, 57
6	2	2-3/16	900	620PTU*	620DTU*	84	23	38	-	56, 57
6	3	3-1/4	1400	630PTU*	--	86	25, 26	39D	-	-
8	2	2-3/16	1000	820PTU*	820DTU*	84	23	38	-	56, 57
8	3	3-1/4	1500	830PTU*	--	86	25, 26	39D	-	-
10	3	3-1/4	1650	1030PTU*	--	86	25, 26	39D	-	-
12	3	3-1/4	1800	1230PTU*	--	86	25, 26	39D	-	-

Plain Bore Diameter	Part #
1-3/16 Plain Bore	84
1-15/16 Plain Bore	86
7/8 Plain Bore	89

Bearing Options	Part #
3/4 Roller	23
1 Roller	25
1-1/4 Roller	26
1/2 Q34 Precision Ball	38
3/4 Double Groove Precision	39D
1/2 Delrin	56
3/4 Delrin	57

Suffix Color Code:

X G J U A



PPU Polyurethane on Polyolefin

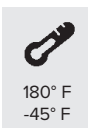
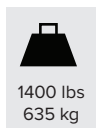

Features

- Injection Molded Polyurethane
- 90-95 Durometer Shore (A) Polyurethane Tread chemically bonded to polyolefin core
- High capacity and lightweight
- Resists oil, grease water and most solvents
- Non-marking, smooth rolling and quiet
- Various colors available

Wheel Dia.	Tread Width	Hub Length	Load Cap.	Part #	*Plain Bore	*Roller	*Precision Ball	*Flanged Ball	Delrin
2	7/8	1	100	278PPU*	80	-	-	-	-
2-1/2	7/8	1	100	2578PPU*	80	-	-	-	-
3	7/8	1	100	378PPU*	80	-	-	-	-
3	1-1/4	1-9/16	250	314PPU*	-	-	34	-	-
3-1/2	1-1/4	1-9/16	275	3514PPU*	-	-	34	-	-
4	1-1/4	1-9/16	300	414PPU*	-	-	31, 34	-	-
4	2	2-3/16	500	420PPU*	84	23	38	-	56, 57
5	1	1-1/8	145	510PPU*	81	-	-	-	-
5	1-1/4	1-9/16	325	514PPU*	-	-	31, 34	41, 42	-
5	2	2-3/16	600	520PPU*	84	23	38	-	56, 57
6	1-1/4	1-9/16	350	614PPU*	-	-	34, 35	42	-
6	2	2-3/16	720	620PPU*	84	23	38	-	56, 57
8	1-1/2	2	600	815PPU*	-	-	-	44,45, 46	-
8	2	2-3/16	800	820PPU*	84	23	38	-	56, 57
10	1-1/2	2	700	1015PPU*	-	-	-	44,45, 46	-
10	2-1/2	2-3/4	1400	1025PPU*	86	25	-	-	-



Plain Bore Diameter	Part #
1/4 Plain Bore	80
5/16 Plain Bore	81
1-3/16 Plain Bore	84
1-15/16 Plain Bore	86

Bearing Options	Part #
3/4 Roller	23
1 Roller	25
5/16 Precision Thread Guard	31
3/8 Precision Full Thread Guard	34
3/8 Precision Small Thread Guard	35
1/2 Q34 Precision Ball	38
5/16 Flanged Ball	41
3/8 Flanged Ball	42
1/2 Flanged Ball	44
5/8 Flanged Ball	45
3/4 Flanged Ball	46
1/2 Delrin	56
3/4 Delrin	57

DUA | TUA | DSU

DUA | TUA SIRIUS Heavy Duty Polyurethane on Aluminum





2000 lbs
900 kg



180° F
-40° F

Features

- High grade polyurethane tread
- Softer **85 Durometer Shore (A)** deflects debris
- Non-marking and rolls effortlessly
- Unmatched load capacities in its class
- Ideal for towline applications
- Multiyear tread durability



Wheel Dia.	Tread Width	Hub Length*	Load Cap.	Flat Tread Part #	Donut Tread Part #	Precision Ball
3	1-13/16	2-1/16	550	-	3113DUA62MT	62
4	1-1/2	1-15/16	600	-	415DUA62MT	62
4	2	2-7/16	1000	-	420DUA63MT	63
5	1-1/2	1-15/16	700	-	515DUA62MT	62
5	2	2-7/16	1200	-	520DUA63MT	63
6	1-1/2	1-15/16	800	-	615DUA62MT	62
6	2	2-7/16	1500	620TUA63MT	620DUA63MT	63
8	2	2-7/16	2000	820TUA63MT	820DUA63MT	63
8	2	2-7/16	2000	820TUA63MT-W	820DUA63MT-W	64

Bearing Options	Part #
6202 Precision Ball	62
6203 Precision Ball	63
6204 Precision Ball	64

* Hub Length includes top hat bushings

W - Waffle Core

DSU REGAL Polyurethane on Ductile Steel Core





3500 lbs
1587 kg



180° F
-40° F

Features

- Crowned high grade polyurethane tread
- **87 (±5) Shore (A) Durometer**
- High capacity heavy duty ductile steel core
- Non-marking and rolls effortlessly utilizing larger **6205 precision ball bearings**
- Unmatched load capacities in its class
- Ideal for towline applications and heavy machinery
- Multiyear tread durability

Wheel Dia.	Tread Width	Hub Length*	Load Cap.	Flat Tread Part #	Precision Ball
6	3	3-1/4	2900	620DSU65M	65
8	3	3-1/4	3000	820DSU65M	65
10	3	3-1/4	3200	1030DSU65M	65
12	3	3-1/4	3500	1230DSU65M	65

Bearing Options	Part #
6205 Precision Ball	65

* Hub Length includes top hat bushings

SPU Solid Polyurethane

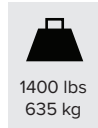

Features

- **63 (±5) Durometer Shore (D)**
- **100% washable**
- **One piece mold design eliminates bonding failure**
- **High impact and abrasion resistant**
- **Resists oil, grease, water and most solvents**
- **Perfect for food processing equipment and other stainless applications**

Bearing Options	Part #
3/4 Roller	23
1/2 Q34 Precision Ball	38
1/2 Delrin	56
3/4 Delrin	57
1/2 Plain Bore	83
1-3/16 Plain Bore	84

Wheel Dia.	Tread Width	Hub Length	Load Cap.	Plain Bore Dia.	Part #	*Plain Bore	*Roller	*Precision Ball	*Delrin
3	1-1/4	1-9/16	300	1/2	314SPU*	83	-	-	-
4	1-1/4	1-9/16	400	1/2	414SPU*	83	-	-	-
4	2	2-3/16	800	1-3/16	420SPU*	84	23	38	56, 57
5	1-1/4	1-9/16	700	1/2	514SPU*	83	-	-	-
5	2	2-3/16	1000	1-3/16	520SPU*	84	23	38	56, 57
6	2	2-3/16	1200	1-3/16	620SPU*	84	23	38	56, 57
8	2	2-3/16	1400	1-3/16	820SPU*	84	23	38	56, 57

HU Heavy Duty Solid Polyurethane on Glass-filled Nylon

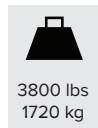

Features

- **Extra Heavy Duty solid elastomer**
- **70 Shore (D) durometer**
- **100% washable**
- **High impact and abrasion resistant**
- **Resists oil, grease, water and most solvents**
- **Multi-year tread durability**
- **Perfect for food processing equipment and other stainless applications**

Bearing Options	Part #
3/4 Roller	23
1/2 Q34 Precision Ball	38
1/2 Delrin	56
3/4 Delrin	57
6203 Precision Ball	63
6205 Precision Ball	65

Wheel Dia.	Tread Width	Hub Length	Load Cap.	Plain Bore Dia.	Part #	*Plain Bore	*Roller	*Precision Ball	*Delrin
4	2	2-3/16	1200	1-3/16	420HU*	84	23	38, 63	56, 57
5	2	2-3/16	1500	1-3/16	520HU*	84	23	38, 63	56, 57
6	2	2-3/16	1800	1-3/16	620HU*	84	23	38, 63	56, 57
6	2-1/2	2-3/4	2300	-	625HU65X	-	-	65	-
6	3	3-1/4	3000	-	630HU65X	-	-	65	-
8	2	2-3/16	2100	1-3/16	820HU*	84	23	38, 63	56, 57
8	2-1/2	2-3/4	2450	-	825HU65X	-	-	65	-
8	3	3-1/4	3200	-	830HU65X	-	-	65	-
10	2-1/2	2-3/4	2600	-	1025HU65X	-	-	65	-
10	3	3-1/4	3500	-	1030HU65X	-	-	65	-
12	3	3-1/4	3800	-	1230HU65X	-	-	65	-

MU | MX

MU Polyurethane on Glass-filled Nylon

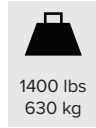

Features

- 10mm thick polyurethane tread
- 90-95 Durometer Shore (A)
- Light weight reinforced glass-filled nylon core
- Non-marking, non-staining, non-conductive tread
- Resists oil, grease, water and solvents
- Multi-year tread durability

Bearing Options	Part #
3/4 Roller	23
1/2 Q34 Precision Ball	38
1/2 Delrin	56
3/4 Delrin	57

Wheel Dia.	Tread Width	Hub Length	Load Cap.	Plain Bore Dia.	Part #	*Plain Bore	*Roller	*Precision Ball	Delrin
4	2	2-3/16	800	1-3/16	420MU*	84	23	38	56, 57
5	2	2-3/16	1000	1-3/16	520MU*	84	23	38	56, 57
6	2	2-3/16	1200	1-3/16	620MU*	84	23	38	56, 57
8	2	2-3/16	1400	1-3/16	820MU*	84	23	38	56, 57

MX Polyurethane on Glass-filled Nylon

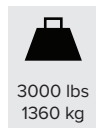



Features

- 23mm thick polyurethane thread
- 90-95 Durometer Shore (A) (Maroon tread)
- 70-80 Durometer Shore (D) (Blue tread)
- Light weight reinforced glass-filled nylon core
- Non-marking, non-staining, non-conductive tread
- Resists oil, grease, water and solvents
- Multi-year tread durability

Wheel Dia.	Tread Width	Hub Length	Load Cap.	Plain Bore Dia.	Part #	*Plain Bore	*Roller	*Precision Ball	Bearing Options	Part #
6	2-1/2	2-3/4	1600	1-15/16	625MX*	86	25, 26	-	3/4 Roller	23
6	3	3-1/4	2000	1-15/16	630MX*	86	25, 26	39D, 40D	1 Roller	25
8	2-1/2	2-3/4	2000	1-15/16	825MX*	86	25, 26	-	1-1/4 Roller	26
8	3	3-1/4	2500	1-15/16	830MX*	86	25, 26	39D, 40D	3/4 Double Groove Precision	39D
10	2-1/2	2-3/16	2200	1-15/16	1025MX*	86	25, 26	-	1 Double Groove Precision	40D
10	3	3-1/4	3000	1-15/16	1030MX*	86	25, 26	39D, 40D		

PU Polyurethane on Steel



 3500 lbs 1585 kg	 180° F -45° F
--	---

Features



- 90-95 Durometer Shore (A)
- 10 mm thick polyurethane tread
- Chemically bonded to heavy steel core
- Non-marking, non-staining, non-conductive tread
- Resists oil, grease, water and solvents
- Zerk fitting

Bearing Options	Part #
3/4 Roller	23
1 Roller	25
1-1/4 Roller	26
1/2 Q34 Precision Ball	38
3/4 Double Groove Precision	39D
1 Double Groove Precision	40D

Wheel Dia.	Tread Width	Hub Length	Load Cap.	Plain Bore Dia.	Part #	*Plain Bore	*Roller	*Precision Ball
3-1/4	2	2-3/16	600	1-3/16	3420PU*	84	23	38
4	1-1/2	2-3/16	600	1-3/16	415PU*	84	23	38
4	2	2-3/16	700	1-3/16	420PU*	84	23	38
5	1-1/2	2-3/16	700	1-3/16	515PU*	84	23	38
5	2	2-3/16	1000	1-3/16	520PU*	84	23	38
6	2	2-3/16	1200	1-3/16	620PU*	84	23	38
6	2-1/2	2-3/4	1600	1-15/16	625PU*	86	25, 26	-
6	3	3-1/4	2000	1-15/16	630PU*	86	25, 26	39D, 40D
8	2	2-3/16	1400	1-3/16	820PU*	84	23	38
8	2-1/2	2-3/4	2000	1-15/16	825PU*	86	25, 26	-
8	3	3-1/4	2500	1-15/16	830PU*	86	25, 26	39D, 40D
10	2-1/2	2-3/4	2200	1-15/16	1025PU*	86	25, 26	-
10	3	3-1/4	3000	1-15/16	1030PU*	86	25, 26	39D, 40D
12	2-1/2	2-3/4	2500	1-15/16	1225PU*	86	25, 26	-
12	3	3-1/4	3500	1-15/16	1230PU*	86	25, 26	39D, 40D

EX Heavy Duty Polyurethane on Steel



 6000 lbs 2720 kg	 180° F -45° F
--	---

Features

- 90-95 Durometer Shore (A)
- Extra Heavy Duty cast iron core
- Extra thick 3/4" polyurethane tread

Bearing Options	Part #
1 Roller	25
1-1/4 Roller	26
1-1/2 Roller	27
3/4 Double Groove Precision	39D
1 Double Groove Precision	40D

Wheel Dia.	Tread Width	Hub Length	Load Cap.	Plain Bore Dia.	Part #	*Plain Bore	*Roller	*Precision Ball
6	3	3-1/4	3000	1-15/16	630EX*	86	25, 26	39D, 40D
8	3	3-1/4	3500	1-15/16	830EX*	86	25, 26	39D, 40D
10	3	3-1/4	4000	1-15/16	1030EX*	86	25, 26	39D, 40D
12	3	3-1/4	4500	1-15/16	1230EX*	86	25, 26	39D, 40D
12	4	4-1/4	6000	2-7/16	1240EX*	87	27	-

PH | MA

PH Phenolic



	
3500 lbs 1585 kg	250° F -50° F

Bearing Options	Part #
1/2 Roller	21
3/4 Roller	23
1 Roller	25
1-1/4 Roller	26
1/2 Q34 Precision Ball	38

Features

- **90 (±5) Durometer Shore (D)**
- Use metal only bearing components for temperatures over 250° F
- Resistant to high shock, impact, oils and grease
- Economic wheel made in the USA
- NOT recommended for wet applications
- Zerk fittings available in 5, 6, 8 x 2 as well as all 2-1/2 & 3 wide wheels

Bearing Options	Part #
3/4 Double Groove Precision	39D
1 Double Groove Precision	40D
1/2 Delrin	56
3/4 Delrin	57

Wheel Dia.	Tread Width	Hub Length	Load Cap.	Plain Bore Dia.	Part #	*Plain Bore	*Roller	*Delrin	*Precision Ball
3	1-1/4	1-3/8	400	1/2, 1-1/16	314PH*	83	21	56	-
3-1/4	2	2-3/16	700	1-3/16	3420PH*	84	23	56, 57	38
3-1/2	1-1/4	1-3/8	400	1-1/16	3514PH*	83	21	56	-
4	1-1/4	1-3/8	400	1/2, 1-1/16	414PH*	83	21	56	-
4	1-1/2	1-5/8	600	1-3/16	415PH*	84	23	56, 57	38
4	2	2-3/16	800	1-3/16	420PH*	84	23	56, 57	38
5	1-1/4	1-3/8	400	1/2, 1-1/16	514PH*	83	21	56	-
5	1-1/2	1-5/8	600	1-3/16	515PH*	84	23	56, 57	38
5	2	2-3/16	1000	1-3/16	520PH*	84	23	56, 57	38
6	1-1/2	1-5/8	800	1-3/16	615PH*	84	23	56, 57	38
6	2	2-3/16	1200	1-3/16	620PH*	84	23	56, 57	38
6	2-1/2	2-3/4	1600	1-15/16	625PH*	86	25, 26	-	-
6	3	3-1/4	2000	1-15/16	630PH*	86	25, 26	-	39D, 40D
8	2	2-3/16	1400	1-3/16	820PH*	84	23	56, 57	38
8	2-1/2	2-3/4	2000	1-15/16	825PH*	86	25, 26	-	-
8	3	3-1/4	2500	1-15/16	830PH*	86	25, 26	-	39D, 40D
10	2-1/2	2-3/4	2500	1-3/16, 1-15/16	1025PH*	84, 86	23, 25, 26	-	-
10	3	3-1/4	2900	1-15/16	1030PH*	86	25, 26	-	39D, 40D
12	2-1/2	2-3/4	3000	1-15/16	1225PH*	86	25, 26	-	-
12	3	3-1/4	3500	1-15/16	1230PH*	86	25, 26	-	39D, 40D

MA Glass-filled Nylon



	
1400 lbs 635 kg	180° F -45° F

Features

- **85 (±5) Durometer Shore (D)**
- Impervious to most chemicals, solvents, oil, salt, alkalines
- Recommended for wet applications

Bearing Options	Part #
3/4 Roller	23
1/2 Q34 Precision Ball	38
1/2 Delrin	56
3/4 Delrin	57
1/2 Plain Bore	83
1-3/16 Plain Bore	84

Wheel Dia.	Tread Width	Hub Length	Load Cap.	Plain Bore Dia.	Part #	*Plain Bore	*Roller	*Delrin	*Precision Ball
3	1-13/16	1-7/8	1200	1-3/16	3113MA*	84	23	56, 57	38, 62, 63
4	2	2-3/16	800	1-3/16	420MA*	84	23	56, 57	38
5	2	2-3/16	1000	1-3/16	520MA*	84	23	56, 57	38
6	2	2-3/16	1200	1-3/16	620MA*	84	23	56, 57	38
8	2	2-3/16	1400	1-3/16	820MA*	84	23	56, 57	38

TPH Hi-Temp Phenolic

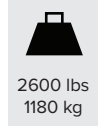

2600 lbs
1180 kg

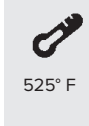

525° F

Features

- 90 (±5) Durometer Shore (D)
- Use metal only bearing components for temperatures over 1°
- Resistant to high shock, impact, oils and grease
- Economic wheel made in the USA
- NOT recommended for wet applications
- +475°F continuous heat resistance
- +550°F (intermittent) heat resistance
- Zerk fittings in 52, 6x2, 8x2, and all 2-1/2 & 3 wide wheels are available

Wheel Dia.	Tread Width	Hub Length	Load Cap.	Plain Bore Dia.	Part #	*Plain Bore	*Roller
3	1-1/4	1-3/8	200	1-1/16	314TPH*	83	-
4	1-1/4	1-3/8	250	1-1/16	414TPH*	83	-
4	2	2-3/16	600	1-3/16	420TPH*	84	23
5	1-1/4	1-3/8	300	1-1/16	514TPH*	83	-
5	2	2-3/16	750	1-3/16	520TPH*	84	23
6	2	2-3/16	900	1-3/16	620TPH*	84	23
6	3	3-1/4	1700	1-15/16	630TPH*	86	25, 26
8	2	2-3/16	1100	1-3/16	820TPH*	84	23
8	3	3-1/4	1900	1-15/16	830TPH*	86	25, 26
10	3	3-1/4	2400	1-15/16	1030TPH*	86	25, 26
12	3	3-1/4	2600	1-15/16	1230TPH*	86	25, 26

Bearing Options	Part #
3/4 Roller	23
1 Roller	25
1-1/4 Roller	26

TMA Hi-Temp Glass-filled Nylon

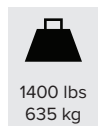

1400 lbs
635 kg

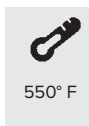

550° F

Features

- 85 (±5) Durometer Shore (D)
- Impervious to most chemicals, solvents, oil, salt, alkalines and water
- +475°F continuous, +550°F intermittent

Wheel Dia.	Tread Width	Hub Length	Load Cap.	Plain Bore Dia.	Part #	*Plain Bore	*Roller
4	1-1/4	1-3/8	700	1/2	414TMA*	83	-
4	2	2-3/16	800	1-3/16	420TMA*	84	23
5	1-1/4	1-3/8	900	1/2	514TMA*	83	-
5	2	2-3/16	1000	1-3/16	520TMA*	84	23
6	2	2-3/16	1200	1-3/16	620TMA*	84	23
8	2	2-3/16	1400	1-3/16	820TMA*	84	23

Bearing Options	Part #
3/4 Roller	23

SS Semi-Steel

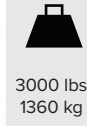
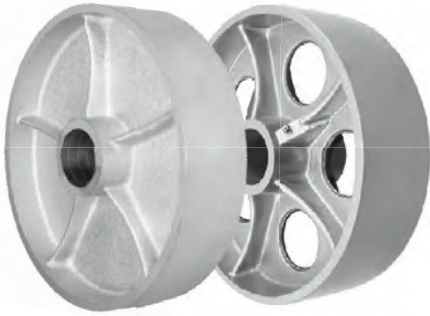

Features

- High capacity
- Use metal only bearing components for temps higher than 180
- Zerk fitting

Bearing Options	Part #
3/4 Roller	23
1 Roller	25
1-1/4 Roller	26
1/2 Q34 Precision Ball	38
3/4 Double Groove Precision	39D
1 Double Groove Precision	40D

Wheel Dia.	Tread Width	Hub Length	Load Cap.	Plain Bore Dia.	Part #	*Plain Bore	*Roller	*Precision Ball
3	1-1/4	1-3/8	350	3/8, 1/2	314SS*	82, 83	-	-
4	1-1/4	1-1/2	425	3/8, 1/2	414SS*	82, 83	-	-
4	2	2-3/16	700	1-3/16	420SS*	84	23	38
5	2	2-3/16	1000	1-3/16	520SS*	84	23	38
6	2	2-3/16	1200	1-3/16	620SS*	84	23	38
6	2-1/2	2-3/4	1800	1-15/16	625SS*	86	25, 26	-
6	3	3-1/4	2500	1-15/16	630SS*	86	25, 26	39D, 40D
8	2	2-3/16	1400	1-3/16	820SS*	84	23	38
8	2-1/2	2-3/4	1800	1-15/16	825SS*	86	25, 26	-
8	3	3-1/4	2500	1-15/16	830SS*	86	25, 26	39D, 40D
10	2-1/2	2-3/4	2000	1-15/16	1025SS*	86	25, 26	-
10	3	3-1/4	3000	1-15/16	1030SS*	86	25, 26	39D, 40D
12	2-1/2	2-3/4	2000	1-15/16	1225SS*	86	25, 26	-
12	3	3-1/4	3000	1-15/16	1230SS*	86	25, 26	39D, 40D

DS Ductile Steel

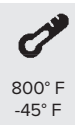
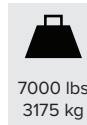

Features

- Extreme Heavy Duty applications
- Heavy core and wheel face
- High capacity
- Tensile strength: 70000 PSI
- Use metal only bearing components for temps higher than 180
- Zerk fitting

Bearing Options	Part #
3/4 Roller	23
1 Roller	25
1-1/4 Roller	26
1/2 Q34 Precision Ball	38
3/4 Double Groove Precision	39D
1 Double Groove Precision	40D

Wheel Dia.	Tread Width	Hub Length	Load Cap.	Plain Bore Dia.	Part #	*Plain Bore	*Roller	*Precision Ball
4	2	2-3/16	1500	1-3/16	420DS*	84	23	38
5	2	2-3/16	1500	1-3/16	520DS*	84	23	38
6	2	2-3/16	2000	1-3/16	620DS*	84	23	38
6	2-1/2	2-3/4	3500	1-15/16	625DS*	86	25, 26	-
6	3	3-1/4	6000	1-15/16	630DS*	86	25, 26	39D, 40D
8	2	2-3/16	2000	1-3/16	820DS*	84	23	38
8	2-1/2	2-3/4	4000	1-15/16	825DS*	86	25, 26	-
8	3	3-1/4	6000	1-15/16	830DS*	86	25, 26	39D, 40D
10	2-1/2	2-3/4	4500	1-15/16	1025DS*	86	25, 26	-
10	3	3-1/4	7000	1-15/16	1030DS*	86	25, 26	39D, 40D
12	3	3-1/4	7000	1-15/16	1230DS*	86	25, 26	39D, 40D

VG V-Groove



	
3000 lbs 1360 kg	800° F -45° F

Features



- V-groove wheels are precision machined 90° with 7/8 relief groove
- Use metal only bearing components for temps higher than 180
- Zerk fitting

Bearing Options	Part #
3/4 Roller	23
1 Roller	25
1-1/4 Roller	26
1/2 Q34 Precision Ball	38
3/4 Double Groove Precision	39D
1 Double Groove Precision	40D

Wheel Dia.	Tread Width	Hub Length	Load Cap.	Plain Bore Dia.	Part #	*Plain Bore	*Roller	*Precision Ball
4	1-1/2	1-5/8	350	1-3/16	415VG*	84	23	38
4	2	2-3/16	700	1-3/16	420VG*	84	23	38
5	2	2-3/16	1000	1-3/16	520VG*	84	23	38
6	2	2-3/16	1200	1-3/16	620VG*	84	23	38
6	2-1/2	2-3/4	1800	1-15/16	625VG*	86	25, 26	-
6	3	3-1/4	2500	1-15/16	630VG*	86	25, 26	39D, 40D
8	2	2-3/16	1400	1-3/16	820VG*	84	23	38
8	2-1/2	2-3/4	1800	1-15/16	825VG*	86	25, 26	-
8	3	3-1/4	2500	1-15/16	830VG*	86	25, 26	39D, 40D
10	3	3-1/4	3000	1-15/16	1030VG*	86	25, 26	39D, 40D
12	3	3-1/4	3000	1-15/16	1230VG*	86	25, 26	39D, 40D

DVG Ductile V-Groove



	
7000 lbs 3175 kg	800° F -45° F

Features

- Extreme Heavy Duty applications
- Heavy core and wheel face
- High capacity
- Tensile strength: 10000 PSI
- Ductile V-groove wheels are precision machined 90° with 7/8 relief groove
- Use metal only bearing components for temps higher than 180
- Zerk fitting

Bearing Options	Part #
3/4 Roller	23
1 Roller	25
1-1/4 Roller	26
1/2 Q34 Precision Ball	38
3/4 Double Groove Precision	39D
1 Double Groove Precision	40D

Wheel Dia.	Tread Width	Hub Length	Load Cap.	Plain Bore Dia.	Part #	*Plain Bore	*Roller	*Precision Ball
4	2	2-3/16	1500	1-3/16	420DVG*	84	23	38
5	2	2-3/16	1500	1-3/16	520DVG*	84	23	38
6	2-1/2	2-3/4	3500	1-15/16	625DVG*	86	25, 26	-
6	3	3-1/4	6000	1-15/16	630DVG*	86	25, 26	39D, 40D
8	2-1/2	2-3/4	4000	1-15/16	825DVG*	86	25, 26	-
8	3	3-1/4	6000	1-15/16	830DVG*	86	25, 26	39D, 40D
10	3	3-1/4	7000	1-15/16	1030DVG*	86	25, 26	39D, 40D

FF | FP | SNP

FF Flat-Free

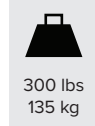

Features

- Quiet, smooth rolling, non-marking
- Maintenance free
- Never flat
- Resists oils, grease water

Bearing Options	Part #
1/2	44
5/8	45
3/4	46

Wheel Dia.	Tread Width	Hub Length	Hub Type	Bearing	Tread Pattern	Load Cap.	Part #
6	2	1-3/8*	1 pc.	Flanged Ball	Sawtooth	250	620FF44L-138F
8 (280/250-4)	3	3-3/16	1 pc.	Flanged Ball	Sawtooth	275	830FF44BL-C
10 (410/350-4)	3-1/2	4	1 pc.	Flanged Ball	Sawtooth	300	1035FF44BS-C
10 (410/350-4)	3-1/2	2-1/4*	1 pc.	Flanged Ball	Sawtooth	300	1035FF45BS-F

* Offset Hub

FP Pneumatic

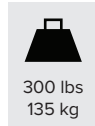

Features

- 4-ply rated tire
- Tube type tire
- Quiet and shock absorbing

Bearing Options	Part #
1/2	44
5/8	45
3/4	46

Wheel Dia.	Tread Width	Hub Length	Hub Type	Bearing	Tread Pattern	Load Cap.	Part #
8 (280/250-4)	3	3	1 pc.	Flanged Ball	Rib	250	830FP44B1JT-1C
10 (410/350-4)	3-1/2	4	3 pc.	Flanged Ball	Sawtooth	300	1035FP44BS-3C
10 (410/350-4)	3-1/2	2-1/4*	3 pc.	Flanged Ball	Sawtooth	300	1035FP45BS-F

* Offset Hub

SNP Semi-Pneumatic on Polyolefin

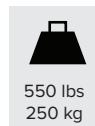

Features

- 70 Durometer Shore (A)
- Cushion rubber tread
- Recyclable material, eco friendly
- Flat-free, puncture proof
- Quiet operation, long lasting
- Smooth rolling, quiet

Bearing Options	Part #
1/2 Flanged Ball	44
5/8 Flanged Ball	45
3/4 Flanged Ball	46

Wheel Dia.	Tread Width	Hub Length	**Bearing Options	Tread Pattern	Load Cap.	Part #
10	2-3/4	2-1/4*	44, 45, 46	Rib	550	10275SNP**AR-F-R

* Off-Centered

Icons

General Information

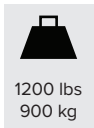

Load Capacity



Temperature Range



NSF Certified



3 Year Warranty

Industries and Applications



Mop Buckets



Industrial



Carts



Bakery



Lawn and Garden



Medical



Tool boxes



Handtrucks



Office



Laboratory



Display Cases



Institutional



Vending Machines



Shopping Carts



Chairs/Mobility



Machinery



Electronics



Automotive



Food Service



Retail



Waste



Platform Trucks



Commercial

Bearings Bushings

Delrin Bearings



I.D.	O.D.	Length	Part #
1/2	7/8	1/2	DB56-89
1/2	1-1/16	1-1/4	DB56-116-1
1/2	1-3/16	7/8	DB56-081914B
1/2	1-3/16	2-1/8	DB56-1
3/4	1-3/16	11/16	DB57
3/4	1-3/16	2-3/16	DB57-1

Roller Bearings



I.D.	O.D.	Length	Part #
1/2	1-1/16	1-1/4	RB21-116
		1-3/8	RB23-15
		1-7/8	RB23-178
3/4	1-3/16	1-7/8	SRB23-178*
		2-1/2	RB23-25
		2-1/2	RB25-25
1	1-15/16	3	RB25-3
		2-1/2	RB26-25
1-1/4	1-15/16	3	RB26-3
		4	RB27-4

*Stainless Steel, prefix "S"

Precision Sealed Ball Bearings



I.D.	O.D.	Part #	
3/8" ID*	15mm	35mm	PB6202
1/2" ID*	17mm	40mm	PB6203
1/2" ID*	20mm	47mm	PB6204
3/4" ID*	25mm	52mm	PB6205

* Stainless Steel, prefix "S"

Flanged HD Precision Ball Bearings

I.D.	O.D.	Part #
1/2	1-3/16	PB38-Q34
		SPB38-Q34*
3/4	1-15/16	PB39-Q34R^
		PB39-Q34D^
1	1-15/16	PB40-Q34D^

* Stainless Steel, prefix "S"



^Part #	Description
R	Single Groove
D	Double Groove

Spanner Bushings



I.D.	O.D.	Length	Steel	Delrin
5/16	3/8	1-5/8	BS050626	--
3/8	1/2	1-5/8	BS060825	BSD060825
		1-7/8	BS081230	--
		2-7/16	BS081239	BSD081239
1/2	3/4	2-7/16	SBS081239*	--
		2-15/16	BS081247	--
		3-1/4	BS121648	--
3/4	1	3-1/2	BS121656	--

* Stainless Steel, prefix "S"

Top Hat Bushings

2 pieces per wheel



I.D.	O.D.	Length	Steel 2pc	Delrin 2pc	Precision Sealed Ball Bearing
1/2	11/16	1-1/8	TH081118	THD081118	PB6203
1/2	11/16	1-1/8	STH081118*	--	SPB6203
1/2	3/4	1-1/8	TH081264	--	PB6204
3/4	15/16	1-5/8	TH14656	--	PB6205

* Stainless Steel, prefix "S"

Ball Bearings Axles & Nuts Retainer Washers

Annular Ball Bearings

1 Piece



I.D.	O.D.	Length	Part #
3/8	7/8	1-9/16	AB071425

Flanged Ball Bearings

I.D.	O.D.	Part #
1/2	1-3/8	FB44
5/8	1-3/8	FB45
3/4	1-3/8	FB46



Zinc Axles & Nuts



O.D.	Length	Plain Axle	Series	Nut	Nut Description
5/16-18	1-3/4	AP0528	06	NT0506N (3/8 Thick)	Nylon Insert
	2	AP0532	06		
	2-1/8	AP0534	06		
3/8-24	2-1/4	AP0636	21, 22, 24, 25, 26	NT0604T (1/4 Thick), NT0607 (7/16 Thick)	Nylon Insert
	3	AP0648	04		
1/2-13	4-1/2	AP0868	100	NT0805, NT0805N (5/16 Thick)	Jam Nut; Suffix N = Nylon Insert
	5-1/8	AP0882	100		

O.D.	Length	Zerk Axle	Series	Nut	Nut Description
3/8-24	2-1/4	AZ0636	21, 22, 24	NT0604T (1/4 Thick), NT0607 (7/16 Thick)	Nylon Insert
	3	AZ0848	X05		
1/2-13	3-3/8	AZ0856	30, 34, 35, 40, 46	NT0805, NT0805N (5/16 Thick)	Jam Nut; Suffix N = Nylon Insert
	3-5/8	AZ0856T	30, 34, 35, 40, 46		
	4	AZ0864	35, 46, 100		
3/4-10	4-3/4	AZ1276	60, 90, 91, 92	NT1207 (7/16 Thick)	Jam Nut
	5-1/2	AZ1288	60, 90, 91, 92		

Suffix "T" is for casters with brakes.

Stainless Steel Axles & Nuts

O.D.	Length	Zerk Axle	Series	Nut	Nut Description
3/8-16	2-1/4	SAZ0636	S24	SNT0605 (5/16 Thick)	Jam Nut
	3	SAZ0848	S30		
1/2-13	3-1/4	SAZ0856	S30	SNT0805N (5/16 Thick)	Nylon Insert

Retainer Washers



I.D.	O.D.	Plastic Combo	Steel Combo	Steel Washer
3/4	1-3/16	RWP1219	RWS1219	WS1219
1	1-15/16	--	RWS1631	WS1631
	2-7/16	--	--	WS1639
1-1/4	1-15/16	--	--	WS2031

Brakes

Total Lock & Directional Lock Brake Kits

Includes Axle & Nut



Wheel Dia.	Series	Total Lock #	Directional Lock #
4	34	TTL420 Kit	DL420 Kit
5	34	TTL520 Kit	DL520 Kit
6	34	TTL620 Kit	DL620 Kit
8	34	TTL820 Kit	DL820 Kit

Top Lock Brake Kits

Includes Axle & Nut



Wheel Dia.	Wheel Width	Series	Part #
3	1-1/4	21, 22, 24	TLB314 Kit
3-1/2	1-1/4	21, 22, 24	TLB3514 Kit
4	1-1/4	21, 22, 24	TLB414 Kit
4	2	30, 34, 35, 40, 46	TLB420 Kit
5	1-1/4	21, 22, 24	TLB514 Kit
5	2	30, 34, 35, 40, 46	TLB520 Kit
6	1-1/4	24	TLB614 Kit
6	2	30, 34, 35, 40, 46	TLB620 Kit
8	2	30, 34, 35, 40, 46	TLB820 Kit

Stainless Steel Top Lock Brakes

Includes Axle & Nut

Wheel Dia.	Wheel Width	Series	Part #
4	2	S30	STLB420-30 Kit
5	2	S30	STLB520-30 Kit
6	2	S30	STLB620-30 Kit
8	2	S30	STLB820-30 Kit

4 Position Swivel Lock



Top Plate #	Top Plate Size	Series	Part #
03	4 x 4-1/2	30, 34, 40	PSL-03
03	4 x 4-1/2	Stainless 30	PSL-S03
04	4-1/2 x 6-1/4	35, 40, 60, 91	PSL-04
06	5-1/4 x 7-1/4	90, 92	PSL-06

Side Lock Brakes



Wheel Dia.	**Series	Part #
3, 4, 5	06	SLB-06
2, 3	10	SLB-10
2.5	10	SLB-25

Cam Lock Brake Kits

Includes Axle & Nut



Wheel Dia.	Wheel Width	Series	Part #
4, 5, 6, 8	2	30, 40, 46	CMB30 Kit

Posi-Lock Brakes

Features

- Stainless steel construction with nylon brake pedal
- For 21, 24 & S24 Series casters



Wheel Dia.	Wheel Width	Series	Part #
3	1-1/4	21, 24	HS314
3-1/2	1-1/4	21, 24	HS3514
4	1-1/4	21, 24	HS414
5	1-1/4	21, 24	HS514
6	1-1/4	24	HS614

Face Contact Brake

Features

- Side set screws lock arms to fork legs
- Adjustable foot brake
- Includes axle and nut



Wheel Dia.	Wheel Width	Series	Part #
6	3	60, 90, 91, 92	FB630 KIT
8	3	60, 90, 91, 92	FB830 KIT
10	3	60, 90, 91, 92	FB1030 KIT
12	3	60, 90, 91, 92	FB1230 KIT

Miscellaneous Parts

Floor Locks

Features

- Designed to immobilize equipment
- Foot operated
- No-slip rubber base
- Not designed for brake operation or lift support



Plate	Size	Bolt Pattern	Attaching Bolt Dia.
03	4 x 4-1/2	2-5/8 x 3-5/8 to 3 x 3	3/8

Extended Height	Retracted Height	Part #
5-3/4	5-1/16	FL400A
6-5/8	5-5/8	FL500A
7-5/8	6-5/8	FL600A
9-5/8	8-5/8	FL800A
5-7/8	4-5/8	FL400J
6-3/4	5-1/2	FL500J
7-3/4	6-1/2	FL600J
9-3/4	8-1/2	FL800J

Caster Pads

Quick-Change



Features

- Allows rapid in-field caster replacement
- Heavy gauge formed steel
- Includes Carriage bolt and nut

Plate Size	Bolt Pattern	Attaching Bolt Dia.	Part #
2-3/8 x 3-5/8	Weld On	--	CP-01 KIT
4 x 4-1/2	2-5/8 x 3-5/8 to 3 x 3	3/8	CP-03 KIT

Corner Bumper



Features

- Non-marking; Steel Reinforced
- 2 mounting holes 5/16" diameter on each side
- 3" long sides; 1" thick

Part #
CB-L31

Raceway Seals



Features

- Flexible rubber tightly seals raceway
- Protects raceway from dirt and debris
- Improves grease retention

Raceway	Part #
Upper	SU30
Lower	SL30

* For 30 Series Yokes

Caster Bumper



Features

- Use with 0845 and 0865 Grip Ring Stem
- Protects walls and equipment from bumps and abrasions

Part #
CB-77

Steel Thread Guards



I.D.	O.D.	Part #
1/2	2-3/4	TG4
	3	TG5
	3-1/2	TG6
	5-1/2	TG8

Rubber Expandable Adapter



Tube I.D.	Expansion Range	Part #
3/4	0.720 - 0.851	EA90
7/8	0.852 - 0.927	EA91
1	0.928 - 1.029	EA92
1-1/8	1.030 - 1.140	EA93
1-1/4	1.141 - 1.359	EA94
1-3/8	1.360 - 1.425	EA95
1-1/2	1.426 - 1.589	EA96
1-7/8	1.790 - 1.850	EA97