



Castors & Wheels

Looking For Better Solution



General Wheel Selection Guide

The information below only serves as a general guideline when selecting wheel type; that the value should be regarded for comparison only and not as an absolute indicator.

Temperature and Chemical Resistance*

	Wheel Series	Hub Material	Tire Material	Short-term Temp. Range
	PRB	Plastic	Grey color elastic rubber	-40/+80 ___
	SRB	Pressed steel	Grey color elastic rubber	-40/+80 °C
	SRB/BKAS	Pressed steel	Black color conductive rubber	-40/+80 ___
	TPR	Plastic	Grey color thermoplastic rubber	-40/+120 ___
	TPR/AS	Anti-static plastic	Grey color conductive thermoplastic rubber	-40/+120 ___
	TPU	Plastic	Grey color polyurethane	-40/+120 ___
	ARB	Al-alloy	Grey color high elastic rubber	-40/+80 ___
	PM	Nylon	Nylon	-30/+120 ___
	PP	Polypropylene	Polypropylene	-30/+120 ___

* Chemical Resistance refers to ability to withstand chemical content in the environment, either in form of particles suspended in air or surface contaminant on ground. When choosing wheel for the castor, one should also consider the material used for yoke and components as well. If castor/wheel is required for special condition, please consult Catis Engineering Team at service@catis.com.tw.



Long-term Temp. Range	Fats	Salt Water	Petrol & Fuel oil	Acid/Alkali	Detergent	Lubricating Oil or Grease
-10/+60	Fair	Good	Fair	Fair	Fair	Fair
-10/+60	Fair	Good	Fair	Fair	Fair	Fair
-10/+60	Fair	Good	Fair	Fair	Fair	Fair
-20/+80	Good	Good	Good	Fair	Fair	Good
-20/+80	Good	Good	Good	Fair	Fair	Good
-20/+80	Good	Good	Good	Fair	Fair	Good
-10/+60	Fair	Good	Fair	Fair	Fair	Fair
-30/+100	Good	Good	Good	Good	Good	Good
-30/+100	Good	Good	Good	Good	Good	Good

 Good  Fair  Poor



PRB

Plastic hub, grey color elastic rubber tire

mm	mm		mm		mm		kg		Code
75	32		39.6	PA	8.3	PA	50	80±5 A	W324
75	32		39.6	PA	9.7	PA	50	80±5 A	W324A
100	32		41.2	PP	8.3	Steel	80	80±5 A	W424
125	32		41.2	PP	8.3	Steel	100	80±5 A	W524
150	32		41.2	PP	8.3	Steel	100	80±5 A	W624
100	32		41.2	PP	9.7	Steel	80	80±5 A	W424A
125	32		41.2	PP	9.7	Steel	100	80±5 A	W524A
150	32		41.2	PP	9.7	Steel	100	80±5 A	W624A
100	32		41.2	PP	8.3	Steel	80	80±5 A	W424C
125	32		41.2	PP	8.3	Steel	100	80±5 A	W524C
150	32		41.2	PP	8.3	Steel	100	80±5 A	W624C
150	32		41.2	PP	8.3	Steel	110	80±5 A	W624U



SRB

Pressed steel hub, grey color elastic rubber tire

mm	mm		mm		mm		kg		Code
100	32		41.2	Steel	8.3	Steel	80	80±5 A	W423
125	32		41.2	Steel	8.3	Steel	100	80±5 A	W523
150	32		41.2	Steel	8.3	Steel	100	80±5 A	W623
100	32		41.2	Steel	9.7	Steel	80	80±5 A	W423A
125	32		41.2	Steel	9.7	Steel	100	80±5 A	W523A
150	32		41.2	Steel	9.7	Steel	100	80±5 A	W623A





TPR

Plastic hub, grey color thermoplastic rubber tire

mm	mm		mm		mm		kg		Code
75	25		32.4	PP	8.3	Steel	45	70±5 A	W303CX
75	25		32.4	PP	8.3	PP	45	70±5 A	W312
100	25		32.4	PP	8.3	PP	60	70±5 A	W412
125	25		32.4	PP	8.3	PP	70	70±5 A	W512
100	32		41.2	PP	8.3	PP	80	70±5 A	W403
125	32		41.2	PP	8.3	PP	100	70±5 A	W503
125	32		41.2	PP	8.3	PP	100	70±5 A	W503U
150	32		41.2	PP	8.3	PP	110	70±5 A	W603U
100	32		41.2	PP	8.3	Steel	80	70±5 A	W403C
125	32		41.2	PP	8.3	Steel	100	70±5 A	W503C
100	32		41.2	PP	9.7	Steel	80	70±5 A	W403AX
125	32		41.2	PP	9.7	Steel	100	70±5 A	W503AX
200	32		41.2	PP	8.3	Steel	120	90±5 A	W803UX
125	32		41.2	PP	8.3	PP	100	70±5 A	W502E
150	40		56.2	PP	12.3	Steel	150	70±5 A	W630UX

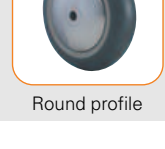
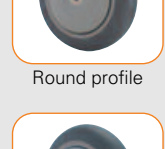
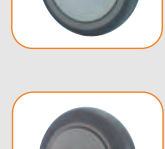
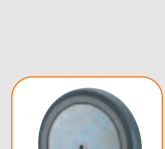
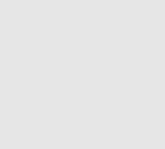

Round profile

Round profile



TPU

Plastic hub, grey color polyurethane tire

















mm	mm		mm		mm		kg		Code
75	25		32.4	PA	8.3	Steel	45	85±5 A	W313X
100	25		32.4	PP	8.3	Steel	60	85±5 A	W413X
125	25		32.4	PP	8.3	Steel	70	85±5 A	W513X
75	32		39.6	PA	8.3	PA	50	95±5 A	W300
75	32		39.6	PA	9.7	PA	50	95±5 A	W300A
100	32		39.6	PP	8.3	PP	80	85±5 A	W400
125	32		39.6	PP	8.3	PP	100	85±5 A	W500
100	32		39.6	PP	9.7	PP	80	85±5 A	W400A
125	32		39.6	PP	9.7	PP	100	85±5 A	W500A
100	32		41.2	PP	8.3	PP	80	85±5 A	W400E
125	32		41.2	PP	8.3	PP	100	85±5 A	W500E
150	32		41.2	PP	8.3	PP	100	85±5 A	W600E
100	32		41.2	PP	8.3	Steel	80	85±5 A	W400CX
125	32		41.2	PP	8.3	Steel	100	85±5 A	W500CX
150	32		41.2	PP	8.3	Steel	100	85±5 A	W600CX





TPU

Plastic hub, grey color polyurethane tire

 mm	 mm		 mm		 mm		 kg		Code
100	32		39.6	PP	8.3	PP	80	95±5 A	W427
125	32		39.6	PP	8.3	PP	100	95±5 A	W527
100	32		39.6	PP	9.7	PP	80	95±5 A	W427A
125	32		39.6	PP	9.7	PP	100	95±5 A	W527A
100	32		39.6	PP	8.3	—	80	95±5 A	W427C
125	32		39.6	PP	8.3	—	100	95±5 A	W527C
125	32		41.2	PP	8.3	PP	100	85±5 A	W501E
125	32		41.2	PP	8.3	Steel	100	85±5 A	W501X
125	32		41.2	PP	8.3	Steel	100	85±5 A	W501UX



Round profile



Round profile

Abbrev.: PA Polyamide ; PP Polypropylene ; AL Aluminum alloy



ARB

Al-alloy hub, grey color high elastic rubber tire

mm	mm		mm		mm		kg		Code
125	32		41.2	AL	8.3	Steel	100	65±5 A	W529UX
150	32		41.2	AL	8.3	Steel	120	65±5 A	W629UX
200	32		41.2	AL	8.3	Steel	120	65±5 A	W829UX
150	40		56.2	AL	12.3	Steel	150	65±5 A	W640UX
200	40		56.2	AL	12.3	Steel	150	65±5 A*	W840UX
*75±5 A also available									
150	32		41.2	AL	8.3	Steel	120	65±5 A	W629UFX
200	32		41.2	AL	8.3	Steel	120	85±5 A	W829UFX



Round profile

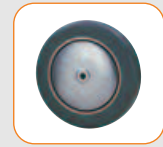

Flat profile



PM

Solid nylon wheel

mm	mm		mm		mm		kg		Code
75	32		41.2	Steel	8.3	Steel	50	60 D	W309RX
100	32		41.2	Steel	8.3	Steel	80	60 D	W409RX
125	32		41.2	Steel	8.3	Steel	100	60 D	W509RX
75	32		41.2	Steel	8.3	Steel	50	60 D	W309CX
100	32		41.2	Steel	8.3	Steel	80	60 D	W409CX
125	32		41.2	Steel	8.3	Steel	100	60 D	W509CX





Black color wheels also available——add suffix "BK" e.g. W509RX-BK



PP

Solid polypropylene wheel

 mm	 mm		 mm	 mm		 kg	 60 D	Code
75	32		41.2	8.3	Steel	50	60 D	W310RX
100	32		41.2	8.3	Steel	80	60 D	W410RX
125	32		41.2	8.3	Steel	100	60 D	W510RX
75	32		41.2	8.3	Steel	50	60 D	W310CX
100	32		41.2	8.3	Steel	80	60 D	W410CX
125	32		41.2	8.3	Steel	100	60 D	W510CX



Black color wheels also available—add suffix "BK" e.g. W510RX-BK



Abbrev.: **PA** Polyamide ; **PP** Polypropylene ; **AL** Aluminum alloy





















Anti-Corrosion Mating Wheels For Stainless Steel Yokes

All metal parts in stainless steel material, stainless steel bearing with water resistant lubricant



PRB-SS

Plastic hub, grey color elastic rubber tire

 mm	 mm		 mm		 mm		 kg		Code
75	32		39.6	PA	8.3	PA	50	80±5 A	W324S
75	32		39.6	PA	9.7	PA	50	80±5 A	W324AS
100	32		41.2	PP	8.3	S/S	80	80±5 A	W424DS
125	32		41.2	PP	8.3	S/S	100	80±5 A	W524DS
150	32		41.2	PP	8.3	S/S	100	80±5 A	W624DS
100	32		41.2	PP	9.7	S/S	80	80±5 A	W424ADS
125	32		41.2	PP	9.7	S/S	100	80±5 A	W524ADS
150	32		41.2	PP	9.7	S/S	100	80±5 A	W624ADS
100	32		41.2	PP	8.3	S/S	80	80±5 A	W424CS
125	32		41.2	PP	8.3	S/S	100	80±5 A	W524CS
150	32		41.2	PP	8.3	S/S	100	80±5 A	W624CS

















Anti-Corrosion Mating Wheels For Stainless Steel Yokes

All metal parts in stainless steel material, stainless steel bearing with water resistant lubricant



TPR-SS

Plastic hub, grey color thermoplastic rubber tire

 mm	 mm		 mm		 mm		 kg		Code
100	32		41.2	PP	8.3	PP	80	70±5 A	W403DSE
125	32		41.2	PP	8.3	PP	100	70±5 A	W503DSE
100	32		41.2	PP	8.3	S/S	80	70±5 A	W403DS
125	32		41.2	PP	8.3	S/S	100	70±5 A	W503DS
100	32		41.2	PP	8.3	S/S	80	70±5 A	W403CS
125	32		41.2	PP	8.3	S/S	100	70±5 A	W503CS



TPU-SS

Plastic hub, grey color polyurethane tire

 mm	 mm		 mm		 mm		 kg		Code
75	32		39.6	PA	8.3	PA	50	95±5 A	W300S
75	32		39.6	PA	9.7	PA	50	95±5 A	W300AS
100	32		41.2	PP	8.3	S/S	80	85±5 A	W400DS
125	32		41.2	PP	8.3	S/S	100	85±5 A	W500DS
150	32		41.2	PP	8.3	S/S	100	85±5 A	W600DS
100	32		41.2	PP	8.3	S/S	80	85±5 A	W400CS
125	32		41.2	PP	8.3	S/S	100	85±5 A	W500CS
150	32		41.2	PP	8.3	S/S	100	85±5 A	W600CS



Abbrev.: PA Polyamide ; PP Polypropylene ; AL Aluminum alloy ; S/S Stainless steel ;  Stainless steel

Anti-Corrosion Mating Wheels For Stainless Steel Yokes

All metal parts in stainless steel material, stainless steel bearing with water resistant lubricant



PM-SS

Solid nylon wheel

mm	mm		mm	mm		kg	mm	Code
75	32		41.2	8.3	S/S	50	60 D	W309RXS
100	32		41.2	8.3	S/S	80	60 D	W409RXS
125	32		41.2	8.3	S/S	100	60 D	W509RXS
75	32		41.2	8.3	S/S	50	60 D	W309CXS
100	32		41.2	8.3	S/S	80	60 D	W409CXS
125	32		41.2	8.3	S/S	100	60 D	W509CXS



Black color wheels also available——add suffix "BK" e.g. W509CXS-BK



PP-SS

Solid polypropylene wheel

mm	mm		mm	mm		kg	mm	Code
75	32		41.2	8.3	S/S	50	60 D	W310RXS
100	32		41.2	8.3	S/S	80	60 D	W410RXS
125	32		41.2	8.3	S/S	100	60 D	W510RXS
75	32		41.2	8.3	S/S	50	60 D	W310CXS
100	32		41.2	8.3	S/S	80	60 D	W410CXS
125	32		41.2	8.3	S/S	100	60 D	W510CXS



Black color wheels also available——add suffix "BK" e.g. W510CXS-BK



Conductive Wheels

Electrical resistance $\leq 10^4 \Omega$



SRB/BKAS

Steel hub, black color conductive rubber tire

mm	mm		mm		mm		kg		Code
100	32		41.2	Steel	8.3	Steel	80	80±5 A	W423-BKAS
125	32		41.2	Steel	8.3	Steel	100	80±5 A	W523-BKAS
150	32		41.2	Steel	8.3	Steel	100	80±5 A	W623-BKAS
100	32		41.2	Steel	9.7	Steel	80	80±5 A	W423A-BKAS
125	32		41.2	Steel	9.7	Steel	100	80±5 A	W523A-BKAS
150	32		41.2	Steel	9.7	Steel	100	80±5 A	W623A-BKAS



TPR/AS

Anti-static plastic hub, grey color conductive thermoplastic rubber tire

mm	mm		mm		mm		kg		Code
75	25		32.4	PP	8.3	Steel	45	70±5 A	W303CX-AS
100	32		41.2	PP	8.3	PP	80	70±5 A	W403-AS
125	32		41.2	PP	8.3	PP	100	70±5 A	W503-AS
150	32		41.2	PP	8.3	PP	110	70±5 A	W603U-AS
200	32		41.2	PP	8.3	Steel	120	90±5 A	W803UX-AS



Abbrev.: PA Polyamide ; PP Polypropylene ; AL Aluminum alloy; S/S Stainless steel; Stainless steel

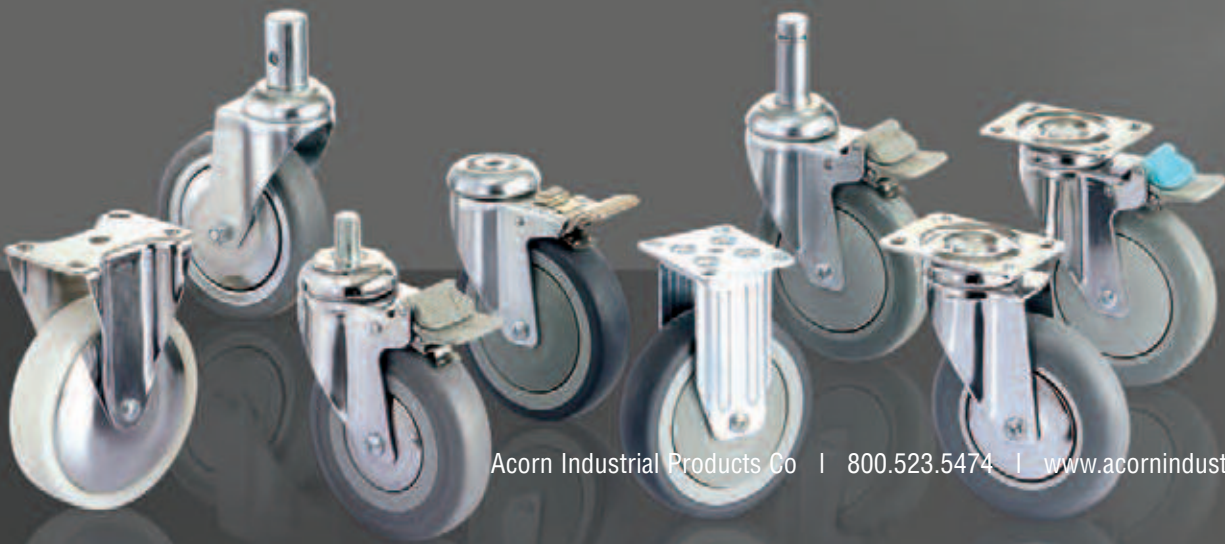

MIRARO

Standard Castors

A standard castor comes with various choices of mounting parts, wheel selections and braking methods making it a highly versatile component for your mobile institutional equipments.

For more appealing appearance, there is also a choice of bright chrome plating over zinc-chromatized plating finish. Anti-static wheels are much preferred by the electronic industry and, wherever ESD poses a major concern to the manufacturing or assembly process.

Application:

Mobile transport equipments used in electronic industry; general trolleys/carts in airports; and other general institutional applications.

Size Available:

75x25, 100x25, 125x25, 75x32, 100x32, 125x32, 150x32, 200x32mm



Pressed steel, double ballrace swivel yoke, zinc-chromatized finish

Option: Bright chrome plated finish is also available, add suffix "-CR" to Catis code, e.g. Y580XP1/W503U-CR



TB/A Total locking brake

Total Lock system locks both swivel head and wheel simultaneously for secure parking. Integrated ON/OFF Nylon brake pedals for easy and quiet operation.



DB/A Directional locking brake

Directional Lock permits free wheel rotation while swivel head remains locked, an easy way to keep equipment traveling straight. Integrated ON/OFF Nylon brake pedals for easy and quiet operation. Release pedal in green color.

P Top Plate Fitting



PRB Wheel Plastic hub, grey color elastic rubber tire

Brake type	mm	mm		mm	mm	mm	mm	mm	kg	Code
TB/A Total locking brake	75	32		95 x 70	75 x 52 / 72 x 45	9.0	33.0	107.0	50	Y380XP1/W324
	75	32		77 x 67	61.5 x 52 / 56 x 45	8.5	33.0	107.0	50	Y380XP2/W324
	100	32		95 x 70	75 x 52 / 72 x 45	9.0	40.5	135.0	80	Y480XP1/W424
	100	32		77 x 67	61.5 x 52 / 56 x 45	8.5	40.5	135.0	80	Y480XP2/W424
	125	32		95 x 70	75 x 52 / 72 x 45	9.0	39.0	161.0	100	Y580XP1/W524
	125	32		77 x 67	61.5 x 52 / 56 x 45	8.5	39.0	161.0	100	Y580XP2/W524
	150	32		95 x 70	75 x 52 / 72 x 45	9.0	50.0	189.5	100	Y680XP1/W624
	150	32		77 x 67	61.5 x 52 / 56 x 45	8.5	50.0	189.5	100	Y680XP2/W624
TB/B Total locking brake	75	32		95 x 70	75 x 52 / 72 x 45	9.0	41.0	107.0	50	Y380P1/W324
	75	32		77 x 67	61.5 x 52 / 56 x 45	8.5	41.0	107.0	50	Y380P2/W324
	100	32		95 x 70	75 x 52 / 72 x 45	9.0	40.5	135.0	80	Y480P1/W424
	100	32		77 x 67	61.5 x 52 / 56 x 45	8.5	40.5	135.0	80	Y480P2/W424
	125	32		95 x 70	75 x 52 / 72 x 45	9.0	39.0	161.0	100	Y580P1/W524
	125	32		77 x 67	61.5 x 52 / 56 x 45	8.5	39.0	161.0	100	Y580P2/W524
	150	32		95 x 70	75 x 52 / 72 x 45	9.0	46.5	189.5	100	Y680P1/W624
	150	32		77 x 67	61.5 x 52 / 56 x 45	8.5	46.5	189.5	100	Y680P2/W624





TB Total locking brake
 Total Lock system simultaneously locks both swivel head and wheel for a secure parking.
 Zinc-alloy brake pedal.

P Top Plate Fitting

PRB Wheel Plastic hub, grey color elastic rubber tire

Brake type	mm	mm	mm	mm	mm	mm	mm	mm	kg	Code
DB Dir. locking brake	100	32		95 x 70	75 x 52 / 72 x 45	9.0	40.5	135.0	80	Y480XDP1/W424
	100	32		77 x 67	61.5 x 52 / 56 x 45	8.5	40.5	135.0	80	Y480XDP2/W424
	125	32		95 x 70	75 x 52 / 72 x 45	9.0	39.0	161.0	100	Y580XDP1/W524
	125	32		77 x 67	61.5 x 52 / 56 x 45	8.5	39.0	161.0	100	Y580XDP2/W524
	150	32		95 x 70	75 x 52 / 72 x 45	9.0	50.0	189.5	100	Y680XDP1/W624
	150	32		77 x 67	61.5 x 52 / 56 x 45	8.5	50.0	189.5	100	Y680XDP2/W624
Non-brake Free swivel	75	32		95 x 70	75 x 52 / 72 x 45	9.0	33.0	107.0	50	Y381P1/W324
	75	32		77 x 67	61.5 x 52 / 56 x 45	8.5	33.0	107.0	50	Y381P2/W324
	75	32		105 x 80	85 x 60 / 75 x 60	10.0	33.0	107.0	50	Y381P3/W324
	100	32		95 x 70	75 x 52 / 72 x 45	9.0	40.5	135.0	80	Y481P1/W424
	100	32		77 x 67	61.5 x 52 / 56 x 45	8.5	40.5	135.0	80	Y481P2/W424
	100	32		105 x 80	85 x 60 / 75 x 60	10.0	40.5	135.0	80	Y481P3/W424
	125	32		95 x 70	75 x 52 / 72 x 45	9.0	39.0	161.0	100	Y581P1/W524
	125	32		77 x 67	61.5 x 52 / 56 x 45	8.5	39.0	161.0	100	Y581P2/W524
	125	32		105 x 80	85 x 60 / 75 x 60	10.0	39.0	161.0	100	Y581P3/W524
	150	32		95 x 70	75 x 52 / 72 x 45	9.0	50.0	189.5	100	Y681P1/W624
	150	32		77 x 67	61.5 x 52 / 56 x 45	8.5	50.0	189.5	100	Y681P2/W624
	150	32		105 x 80	85 x 60 / 75 x 60	10.0	50.0	189.5	100	Y681P3/W624

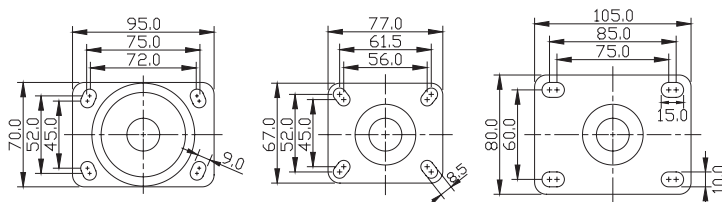

Pressed steel, double ballrace swivel yoke, zinc-chromatized finish

Option: Bright chrome plated finish is also available, add suffix "-CR" to Catis code, e.g. Y580XP1/W503U-CR



TB Total locking brake

Total Lock system locks both swivel head and wheel simultaneously for secure parking. Integrated ON/OFF Nylon brake pedals for easy and quiet operation.



DB Directional locking brake

Directional Lock permits free wheel rotation while swivel head remains locked, an easy way to keep equipment traveling straight. Integrated ON/OFF Nylon brake pedals for easy and quiet operation. Release pedal in green color.

P Top Plate Fitting



PRB Wheel Plastic hub, grey color elastic rubber tire

Brake type	mm	mm	mm	mm	mm	mm	mm	kg	Code
Non-brake Fixed	75	32		95 x 77	75 x 52 / 72 x 45	9.0	107.0	50	Y382P1/W324
	100	32		95 x 77	75 x 52 / 72 x 45	9.0	135.0	80	Y482P1/W424
	125	32		95 x 77	75 x 52 / 72 x 45	9.0	161.0	100	Y582P1/W524
	150	32		95 x 77	75 x 52 / 72 x 45	9.0	189.5	100	Y682P1/W624
	75	32		67 x 77	52 x 61.5 / 45 x 56	8.5	107.0	50	Y385P2/W324
	100	32		67 x 77	52 x 61.5 / 45 x 56	8.5	135.0	80	Y485P2/W424
	125	32		67 x 77	52 x 61.5 / 45 x 56	8.5	161.0	100	Y585P2/W524
	100	32		105 x 80	85 x 60 / 75 x 60	10.0	135.0	80	Y448P3/W424
	125	32		105 x 80	85 x 60 / 75 x 60	10.0	161.0	100	Y548P3/W524

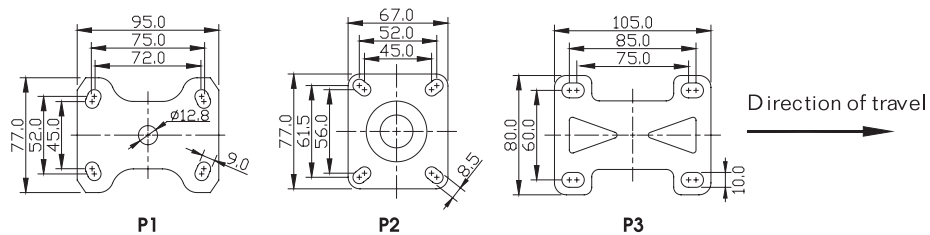



TB/3 Total locking brake
 Total Lock system simultaneously locks both swivel head and wheel for a secure parking.
 Zinc-alloy brake pedal.

P Top Plate Fitting

SRB Wheel Pressed steel hub, grey color elastic rubber tire

Brake type	mm	mm		mm	mm	mm	mm	mm	kg	Code
TB/4 Total locking brake	100	32		95 x 70	75 x 52 / 72 x 45	9.0	40.5	135.0	80	Y480XP1/W423
	100	32		77 x 67	61.5 x 52 / 56 x 45	8.5	40.5	135.0	80	Y480XP2/W423
	125	32		95 x 70	75 x 52 / 72 x 45	9.0	39.0	161.0	100	Y580XP1/W523
	125	32		77 x 67	61.5 x 52 / 56 x 45	8.5	39.0	161.0	100	Y580XP2/W523
	150	32		95 x 70	75 x 52 / 72 x 45	9.0	50.0	189.5	100	Y680XP1/W623
	150	32		77 x 67	61.5 x 52 / 56 x 45	8.5	50.0	189.5	100	Y680XP2/W623
TB/3 Total locking brake	100	32		95 x 70	75 x 52 / 72 x 45	9.0	40.5	135.0	80	Y480P1/W423
	100	32		77 x 67	61.5 x 52 / 56 x 45	8.5	40.5	135.0	80	Y480P2/W423
	125	32		95 x 70	75 x 52 / 72 x 45	9.0	39.0	161.0	100	Y580P1/W523
	125	32		77 x 67	61.5 x 52 / 56 x 45	8.5	39.0	161.0	100	Y580P2/W523
	150	32		95 x 70	75 x 52 / 72 x 45	9.0	46.5	189.5	100	Y680P1/W623
	150	32		77 x 67	61.5 x 52 / 56 x 45	8.5	46.5	189.5	100	Y680P2/W623
DB/4 Dir. locking brake	100	32		95 x 70	75 x 52 / 72 x 45	9.0	40.5	135.0	80	Y480XDP1/W423
	100	32		77 x 67	61.5 x 52 / 56 x 45	8.5	40.5	135.0	80	Y480XDP2/W423
	125	32		95 x 70	75 x 52 / 72 x 45	9.0	39.0	161.0	100	Y580XDP1/W523
	125	32		77 x 67	61.5 x 52 / 56 x 45	8.5	39.0	161.0	100	Y580XDP2/W523
	150	32		95 x 70	75 x 52 / 72 x 45	9.0	50.0	189.5	100	Y680XDP1/W623
	150	32		77 x 67	61.5 x 52 / 56 x 45	8.5	50.0	189.5	100	Y680XDP2/W623

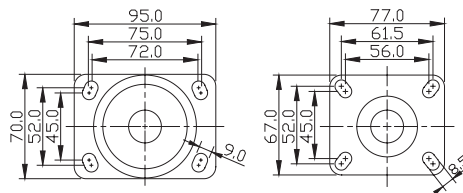

Pressed steel, double ballrace swivel yoke, zinc-chromatized finish

Option: Bright chrome plated finish is also available, add suffix "-CR" to Catis code, e.g. Y580XP1/W503U-CR



TB/A Total locking brake

Total Lock system locks both swivel head and wheel simultaneously for secure parking. Integrated ON/OFF Nylon brake pedals for easy and quiet operation.



DB/A Directional locking brake

Directional Lock permits free wheel rotation while swivel head remains locked, an easy way to keep equipment traveling straight. Integrated ON/OFF Nylon brake pedals for easy and quiet operation. Release pedal in green color.

P Top Plate Fitting



SRB Wheel

Pressed steel hub, grey color elastic rubber tire

Brake type	mm	mm		mm	mm	mm	mm	mm	kg	Code
Non-brake Free swivel	100	32		95 x 70	75 x 52 / 72 x 45	9.0	40.5	135.0	80	Y481P1/W423
	100	32		77 x 67	61.5 x 52 / 56 x 45	8.5	40.5	135.0	80	Y481P2/W423
	100	32		105 x 80	85 x 60 / 75 x 60	10.0	40.5	135.0	80	Y481P3/W423
	125	32		95 x 70	75 x 52 / 72 x 45	9.0	39.0	161.0	100	Y581P1/W523
	125	32		77 x 67	61.5 x 52 / 56 x 45	8.5	39.0	161.0	100	Y581P2/W523
	125	32		105 x 80	85 x 60 / 75 x 60	10.0	39.0	161.0	100	Y581P3/W523
	150	32		95 x 70	75 x 52 / 72 x 45	9.0	50.0	189.5	100	Y681P1/W623
	150	32		77 x 67	61.5 x 52 / 56 x 45	8.5	50.0	189.5	100	Y681P2/W623
	150	32		105 x 80	85 x 60 / 75 x 60	10.0	50.0	189.5	100	Y681P3/W623

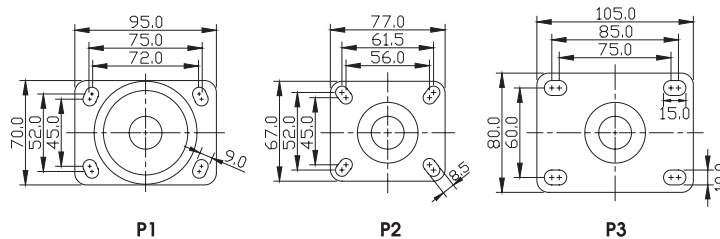





TB Total locking brake
 Total Lock system simultaneously locks both swivel head and wheel for a secure parking.
 Zinc-alloy brake pedal.

P Top Plate Fitting

SRB Wheel Pressed steel hub, grey color elastic rubber tire

Brake type	 mm	 mm		 mm	 mm	 mm	 mm	 mm	 kg	Code	
Non-brake Fixed	100	32		95 x 77	75 x 52 / 72 x 45	9.0	135.0	80		Y482P1/W423	
	125	32		95 x 77	75 x 52 / 72 x 45	9.0	161.0	100		Y582P1/W523	
	150	32		95 x 77	75 x 52 / 72 x 45	9.0	189.5	100		Y682P1/W623	
	100	32		67 x 77	52 x 61.5 / 45 x 56	8.5	135.0	80		Y485P2/W423	
	125	32		67 x 77	52 x 61.5 / 45 x 56	8.5	161.0	100		Y585P2/W523	
	100	32		105 x 80	85 x 60 / 75 x 60	10.0	135.0	80		Y448P3/W423	
	125	32		105 x 80	85 x 60 / 75 x 60	10.0	161.0	100		Y548P3/W523	

SRB/BKAS Wheel Conductive wheels are also available

	Code	
Pressed steel hub and threadguards, zinc-chromatized finish, black color conductive rubber tire	100 x 32mm W423-BKAS	
	125 x 32mm W523-BKAS	
	150 x 32mm W623-BKAS	
Add suffix "-CR" to Catis code for bright chrome finish		

Electrical Resistance $\leq 10^4 \Omega$

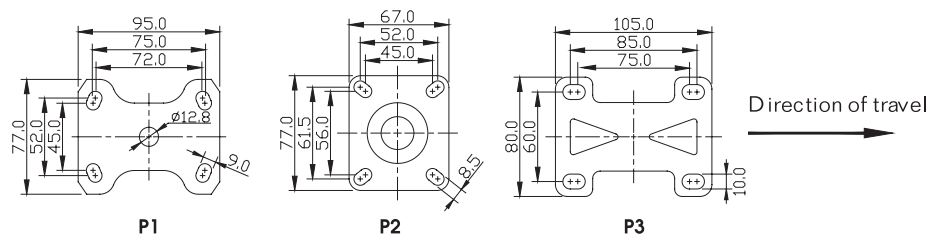

Pressed steel, double ballrace swivel yoke, zinc-chromatized finish

Option: Bright chrome plated finish is also available, add suffix "-CR" to Catis code, e.g. Y580XP1/W503U-CR



TB/A Total locking brake

Total Lock system locks both swivel head and wheel simultaneously for secure parking. Integrated ON/OFF Nylon brake pedals for easy and quiet operation.



DB/A Directional locking brake

Directional Lock permits free wheel rotation while swivel head remains locked, an easy way to keep equipment traveling straight. Integrated ON/OFF Nylon brake pedals for easy and quiet operation. Release pedal in green color.

P Top Plate Fitting

TPR Wheel Plastic hub, grey color thermoplastic rubber tire

Brake type	mm	mm		mm	mm	mm	mm	mm	kg	Code
TB/A Total locking brake	75	25		77 x 67	61.5 x 52 / 56 x 45	8.5	30.0	107.0	45	Y360P2/W312
	100	25		77 x 67	61.5 x 52 / 56 x 45	8.5	38.5	135.0	60	Y460P2/W412
	125	25		95 x 70	75 x 52 / 72 x 45	9.0	38.5	161.0	70	Y560P1/W512
	125	25		77 x 67	61.5 x 52 / 56 x 45	8.5	38.5	161.0	70	Y560P2/W512
	100	32		95 x 70	75 x 52 / 72 x 45	9.0	40.5	135.0	80	Y480XP1/W403
	100	32		77 x 67	61.5 x 52 / 56 x 45	8.5	40.5	135.0	80	Y480XP2/W403
	125	32		95 x 70	75 x 52 / 72 x 45	9.0	39.0	161.0	100	Y580XP1/W503
	125	32		77 x 67	61.5 x 52 / 56 x 45	8.5	39.0	161.0	100	Y580XP2/W503
	125	32		95 x 70	75 x 52 / 72 x 45	9.0	39.0	161.0	100	Y580XP1/W503U
	125	32		77 x 67	61.5 x 52 / 56 x 45	8.5	39.0	161.0	100	Y580XP2/W503U
TB/B Total locking brake	150	32		95 x 70	75 x 52 / 72 x 45	9.0	50.0	189.5	100	Y680XP1/W603U
	150	32		77 x 67	61.5 x 52 / 56 x 45	8.5	50.0	189.5	100	Y680XP2/W603U
	100	32		95 x 70	75 x 52 / 72 x 45	9.0	40.5	135.0	80	Y480P1/W403
	100	32		77 x 67	61.5 x 52 / 56 x 45	8.5	40.5	135.0	80	Y480P2/W403
	125	32		95 x 70	75 x 52 / 72 x 45	9.0	39.0	161.0	100	Y580P1/W503
	125	32		77 x 67	61.5 x 52 / 56 x 45	8.5	39.0	161.0	100	Y580P2/W503
	125	32		95 x 70	75 x 52 / 72 x 45	9.0	39.0	161.0	100	Y580P1/W503U
	125	32		77 x 67	61.5 x 52 / 56 x 45	8.5	39.0	161.0	100	Y580P2/W503U
150	32		95 x 70	75 x 52 / 72 x 45	9.0	46.5	189.5	100	Y680P1/W603U	
150	32		77 x 67	61.5 x 52 / 56 x 45	8.5	46.5	189.5	100	Y680P2/W603U	

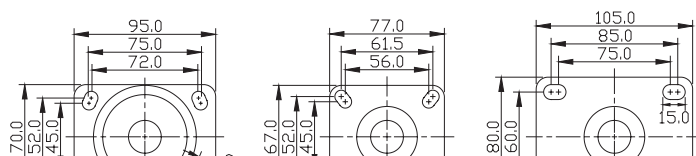



TB Total locking brake
 Total Lock system simultaneously locks both swivel head and wheel for a secure parking.
 Zinc-alloy brake pedal.

P Top Plate Fitting

TPR Wheel Plastic hub, grey color thermoplastic rubber tire

Brake type	mm	mm	mm	mm	mm	mm	mm	mm	kg	Code
DB Dir. locking brake	100	32		95 x 70	75 x 52 / 72 x 45	9.0	40.5	135.0	80	Y480XDP1/W403
	100	32		77 x 67	61.5 x 52 / 56 x 45	8.5	40.5	135.0	80	Y480XDP2/W403
	125	32		95 x 70	75 x 52 / 72 x 45	9.0	39.0	161.0	100	Y580XDP1/W503
	125	32		77 x 67	61.5 x 52 / 56 x 45	8.5	39.0	161.0	100	Y580XDP2/W503
	125	32		95 x 70	75 x 52 / 72 x 45	9.0	39.0	161.0	100	Y580XDP1/W503U
	125	32		77 x 67	61.5 x 52 / 56 x 45	8.5	39.0	161.0	100	Y580XDP2/W503U
	150	32		95 x 70	75 x 52 / 72 x 45	9.0	50.0	189.5	100	Y680XDP1/W603U
	150	32		77 x 67	61.5 x 52 / 56 x 45	8.5	50.0	189.5	100	Y680XDP2/W603U
Non-brake Free swivel	75	25		95 x 70	75 x 52 / 72 x 45	9.0	30.0	107.0	45	Y361P1/W312
	75	25		77 x 67	61.5 x 52 / 56 x 45	8.5	30.0	107.0	45	Y361P2/W312
	100	25		95 x 70	75 x 52 / 72 x 45	9.0	38.5	135.0	60	Y461P1/W412
	100	25		77 x 67	61.5 x 52 / 56 x 45	8.5	38.5	135.0	60	Y461P2/W412
	125	25		95 x 70	75 x 52 / 72 x 45	9.0	38.5	161.0	70	Y561P1/W512
	125	25		77 x 67	61.5 x 52 / 56 x 45	8.5	38.5	161.0	70	Y561P2/W512
	100	32		95 x 70	75 x 52 / 72 x 45	9.0	40.5	135.0	80	Y481P1/W403
	100	32		77 x 67	61.5 x 52 / 56 x 45	8.5	40.5	135.0	80	Y481P2/W403
	100	32		105 x 80	85 x 60 / 75 x 60	10.0	40.5	135.0	80	Y481P3/W403
	125	32		95 x 70	75 x 52 / 72 x 45	9.0	39.0	161.0	100	Y581P1/W503
	125	32		77 x 67	61.5 x 52 / 56 x 45	8.5	39.0	161.0	100	Y581P2/W503
	125	32		105 x 80	85 x 60 / 75 x 60	10.0	39.0	161.0	100	Y581P3/W503
	125	32		95 x 70	75 x 52 / 72 x 45	9.0	39.0	161.0	100	Y581P1/W503U
	125	32		77 x 67	61.5 x 52 / 56 x 45	8.5	39.0	161.0	100	Y581P2/W503U
	125	32		105 x 80	85 x 60 / 75 x 60	10.0	39.0	161.0	100	Y581P3/W503U
	150	32		95 x 70	75 x 52 / 72 x 45	9.0	50.0	189.5	100	Y681P1/W603U
	150	32		77 x 67	61.5 x 52 / 56 x 45	8.5	50.0	189.5	100	Y681P2/W603U



Pressed steel, double ballrace swivel yoke, zinc-chromatized finish

Option: Bright chrome plated finish is also available, add suffix "-CR" to Catis code, e.g. Y580XP1/W503U-CR



TB Total locking brake

Total Lock system locks both swivel head and wheel simultaneously for secure parking. Integrated ON/OFF Nylon brake pedals for easy and quiet operation.



DB Directional locking brake

Directional Lock permits free wheel rotation while swivel head remains locked, an easy way to keep equipment traveling straight. Integrated ON/OFF Nylon brake pedals for easy and quiet operation. Release pedal in green color.

P Top Plate Fitting



TPR Wheel Plastic hub, grey color thermoplastic rubber tire

Brake type	mm	mm		mm	mm	mm	mm	kg	Code	
Non-brake Fixed	100	32		95 x 77	75 x 52 / 72 x 45	9.0	135.0	80	Y482P1/W403	
	125	32		95 x 77	75 x 52 / 72 x 45	9.0	161.0	100	Y582P1/W503	
	125	32		95 x 77	75 x 52 / 72 x 45	9.0	161.0	100	Y582P1/W503U	
	150	32		95 x 77	75 x 52 / 72 x 45	9.0	189.5	100	Y682P1/W603U	
	100	32		67 x 77	52 x 61.5 / 45 x 56	8.5	135.0	80	Y485P2/W403	
	125	32		67 x 77	52 x 61.5 / 45 x 56	8.5	161.0	100	Y585P2/W503	
	125	32		67 x 77	52 x 61.5 / 45 x 56	8.5	161.0	100	Y585P2/W503U	
	100	32		105 x 80	85 x 60 / 75 x 60	10.0	135.0	80	Y448P3/W403	
	125	32		105 x 80	85 x 60 / 75 x 60	10.0	161.0	100	Y548P3/W503	
	125	32		105 x 80	85 x 60 / 75 x 60	10.0	161.0	100	Y548P3/W503U	



TPR/AS Wheel Conductive wheels are also available

	Code	
075 x 25mm	W303CX-AS*	
100 x 32mm	W403-AS	
125 x 32mm	W503-AS	
150 x 32mm	W603U-AS	

Plastic hub and threadguards, grey color conductive thermoplastic rubber tire

*Wheel with metal threadguards (see P020)

Electrical Resistance $\leq 10^4 \Omega$

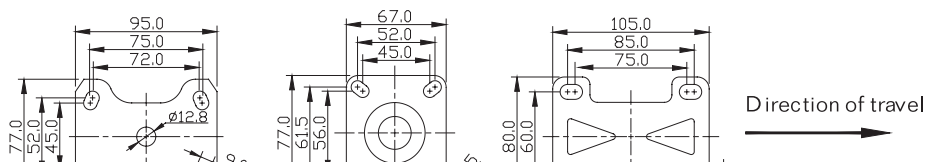



TB/3 Total locking brake
 Total Lock system simultaneously locks both swivel head and wheel for a secure parking.
 Zinc-alloy brake pedal.

P Top Plate Fitting

TPU Wheel Plastic hub, grey color polyurethane tire

Brake type	mm	mm		mm	mm	mm	mm	mm	mm	kg	Code
TB/4 Total locking brake	75	32		95 x 70	75 x 52 / 72 x 45	9.0	33.0	107.0	50		Y380XP1/W300
	75	32		77 x 67	61.5 x 52 / 56 x 45	8.5	33.0	107.0	50		Y380XP2/W300
	100	32		95 x 70	75 x 52 / 72 x 45	9.0	40.5	135.0	80		Y480XP1/W400E
	100	32		77 x 67	61.5 x 52 / 56 x 45	8.5	40.5	135.0	80		Y480XP2/W400E
	125	32		95 x 70	75 x 52 / 72 x 45	9.0	39.0	161.0	100		Y580XP1/W500E
	125	32		77 x 67	61.5 x 52 / 56 x 45	8.5	39.0	161.0	100		Y580XP2/W500E
	150	32		95 x 70	75 x 52 / 72 x 45	9.0	50.0	189.5	100		Y680XP1/W600E
	150	32		77 x 67	61.5 x 52 / 56 x 45	8.5	50.0	189.5	100		Y680XP2/W600E
TB/3 Total locking brake	75	32		95 x 70	75 x 52 / 72 x 45	9.0	41.0	107.0	50		Y380P1/W300
	75	32		77 x 67	61.5 x 52 / 56 x 45	8.5	41.0	107.0	50		Y380P2/W300
	100	32		95 x 70	75 x 52 / 72 x 45	9.0	40.5	135.0	80		Y480P1/W400E
	100	32		77 x 67	61.5 x 52 / 56 x 45	8.5	40.5	135.0	80		Y480P2/W400E
	125	32		95 x 70	75 x 52 / 72 x 45	9.0	39.0	161.0	100		Y580P1/W500E
	125	32		77 x 67	61.5 x 52 / 56 x 45	8.5	39.0	161.0	100		Y580P2/W500E
	150	32		95 x 70	75 x 52 / 72 x 45	9.0	46.5	189.5	100		Y680P1/W600E
	150	32		77 x 67	61.5 x 52 / 56 x 45	8.5	46.5	189.5	100		Y680P2/W600E

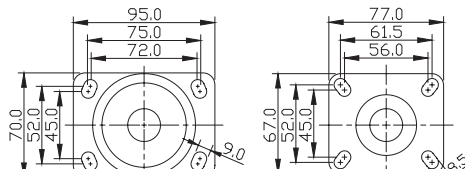

Pressed steel, double ballrace swivel yoke, zinc-chromatized finish

Option: Bright chrome plated finish is also available, add suffix "-CR" to Catis code, e.g. Y580XP1/W503U-CR



TB/4 Total locking brake

Total Lock system locks both swivel head and wheel simultaneously for secure parking. Integrated ON/OFF Nylon brake pedals for easy and quiet operation.



DB/4 Directional locking brake

Directional Lock permits free wheel rotation while swivel head remains locked, an easy way to keep equipment traveling straight. Integrated ON/OFF Nylon brake pedals for easy and quiet operation. Release pedal in green color.

P Top Plate Fitting

TPU Wheel Plastic hub, grey color polyurethane tire

Brake type	mm	mm		mm	mm	mm	mm	mm	kg	Code
Dir. locking brake	100	32		95 x 70	75 x 52 / 72 x 45	9.0	40.5	135.0	80	Y480XDP1/W400E
	100	32		77 x 67	61.5 x 52 / 56 x 45	8.5	40.5	135.0	80	Y480XDP2/W400E
	125	32		95 x 70	75 x 52 / 72 x 45	9.0	39.0	161.0	100	Y580XDP1/W500E
	125	32		77 x 67	61.5 x 52 / 56 x 45	8.5	39.0	161.0	100	Y580XDP2/W500E
	150	32		95 x 70	75 x 52 / 72 x 45	9.0	50.0	189.5	100	Y680XDP1/W600E
	150	32		77 x 67	61.5 x 52 / 56 x 45	8.5	50.0	189.5	100	Y680XDP2/W600E
Non-brake Free swivel	75	32		95 x 70	75 x 52 / 72 x 45	9.0	33.0	107.0	50	Y381P1/W300
	75	32		77 x 67	61.5 x 52 / 56 x 45	8.5	33.0	107.0	50	Y381P2/W300
	75	32		105 x 80	85 x 60 / 75 x 60	10.0	33.0	107.0	50	Y381P3/W300
	100	32		95 x 70	75 x 52 / 72 x 45	9.0	40.5	135.0	80	Y481P1/W400E
	100	32		77 x 67	61.5 x 52 / 56 x 45	8.5	40.5	135.0	80	Y481P2/W400E
	100	32		105 x 80	85 x 60 / 75 x 60	10.0	40.5	135.0	80	Y481P3/W400E
	125	32		95 x 70	75 x 52 / 72 x 45	9.0	39.0	161.0	100	Y581P1/W500E
	125	32		77 x 67	61.5 x 52 / 56 x 45	8.5	39.0	161.0	100	Y581P2/W500E
	125	32		105 x 80	85 x 60 / 75 x 60	10.0	39.0	161.0	100	Y581P3/W500E
	150	32		95 x 70	75 x 52 / 72 x 45	9.0	50.0	189.5	100	Y681P1/W600E
	150	32		77 x 67	61.5 x 52 / 56 x 45	8.5	50.0	189.5	100	Y681P2/W600E
	150	32		105 x 80	85 x 60 / 75 x 60	10.0	50.0	189.5	100	Y681P3/W600E

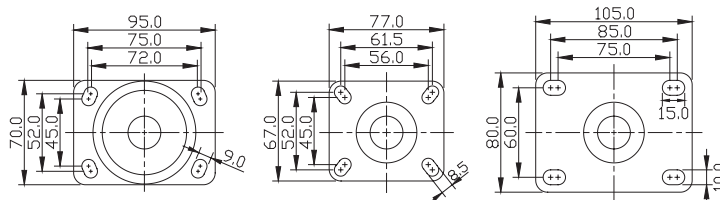



















TLB Total locking brake
 Total Lock system simultaneously locks both swivel head and wheel for a secure parking.
 Zinc-alloy brake pedal.

P Top Plate Fitting

TPU Wheel Plastic hub, grey color polyurethane tire

Brake type	 mm	 mm		 mm	 mm	 mm	 mm	 kg	Code
Non-brake Fixed	75	32		95 x 77	75 x 52 / 72 x 45	9.0	107.0	50	Y382P1/W300
	100	32		95 x 77	75 x 52 / 72 x 45	9.0	135.0	80	Y482P1/W400E
	125	32		95 x 77	75 x 52 / 72 x 45	9.0	161.0	100	Y582P1/W500E
	150	32		95 x 77	75 x 52 / 72 x 45	9.0	189.5	100	Y682P1/W600E
	75	32		67 x 77	52 x 61.5 / 45 x 56	8.5	107.0	50	Y385P2/W300
	100	32		67 x 77	52 x 61.5 / 45 x 56	8.5	135.0	80	Y485P2/W400E
	125	32		67 x 77	52 x 61.5 / 45 x 56	8.5	161.0	100	Y585P2/W500E
	100	32		105 x 80	85 x 60 / 75 x 60	10.0	135.0	80	Y448P3/W400E
	125	32		105 x 80	85 x 60 / 75 x 60	10.0	161.0	100	Y548P3/W500E

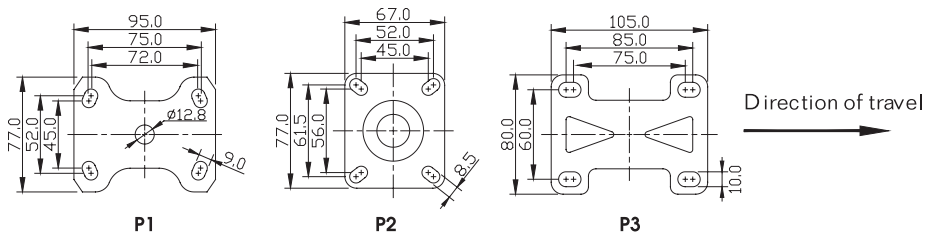

Pressed steel, double ballrace swivel yoke, zinc-chromatized finish

Option: Bright chrome plated finish is also available, add suffix "-CR" to Catis code, e.g. Y580XP1/W503U-CR



TB Total locking brake

Total Lock system locks both swivel head and wheel simultaneously for secure parking. Integrated ON/OFF Nylon brake pedals for easy and quiet operation.



DB Directional locking brake

Directional Lock permits free wheel rotation while swivel head remains locked, an easy way to keep equipment traveling straight. Integrated ON/OFF Nylon brake pedals for easy and quiet operation. Release pedal in green color.

P Top Plate Fitting

ARB Wheel Al-alloy hub, grey color high elastic rubber tire

Brake type	mm	mm		mm	mm	mm	mm	mm	kg	Code
TB Total locking brake	125	32		95 x 70	75 x 52 / 72 x 45	9.0	39.0	161.0	100	Y580XP1/W529UX
	150	32		95 x 70	75 x 52 / 72 x 45	9.0	50.0	189.5	100	Y680XP1/W629UX
DB Dir. locking brake	125	32		95 x 70	75 x 52 / 72 x 45	9.0	39.0	161.0	100	Y580XDP1/W529UX
	150	32		95 x 70	75 x 52 / 72 x 45	9.0	50.0	189.5	100	Y680XDP1/W629UX
Non-brake Free swivel	125	32		95 x 70	75 x 52 / 72 x 45	9.0	39.0	161.0	100	Y581P1/W529UX
	150	32		95 x 70	75 x 52 / 72 x 45	9.0	50.0	189.5	100	Y681P1/W629UX





TB/3 Total locking brake
 Total Lock system simultaneously locks both swivel head and wheel for a secure parking.
 Zinc-alloy brake pedal.

P Top Plate Fitting



PM Wheel Solid nylon wheel

Brake type	mm	mm	mm	mm	mm	mm	mm	mm	kg	Code
TB/4 Total locking brake	75	32		95 x 70	75 x 52 / 72 x 45	9.0	33.0	107.0	50	Y380XP1/W309RX
	75	32		77 x 67	61.5 x 52 / 56 x 45	8.5	33.0	107.0	50	Y380XP2/W309RX
	100	32		95 x 70	75 x 52 / 72 x 45	9.0	40.5	135.0	80	Y480XP1/W409RX
	100	32		77 x 67	61.5 x 52 / 56 x 45	8.5	40.5	135.0	80	Y480XP2/W409RX
	125	32		95 x 70	75 x 52 / 72 x 45	9.0	39.0	161.0	100	Y580XP1/W509RX
	125	32		77 x 67	61.5 x 52 / 56 x 45	8.5	39.0	161.0	100	Y580XP2/W509RX
TB/5 Total locking brake	75	32		95 x 70	75 x 52 / 72 x 45	9.0	41.0	107.0	50	Y380P1/W309RX
	75	32		77 x 67	61.5 x 52 / 56 x 45	8.5	41.0	107.0	50	Y380P2/W309RX
	100	32		95 x 70	75 x 52 / 72 x 45	9.0	40.5	135.0	80	Y480P1/W409RX
	100	32		77 x 67	61.5 x 52 / 56 x 45	8.5	40.5	135.0	80	Y480P2/W409RX
	125	32		95 x 70	75 x 52 / 72 x 45	9.0	39.0	161.0	100	Y580P1/W509RX
	125	32		77 x 67	61.5 x 52 / 56 x 45	8.5	39.0	161.0	100	Y580P2/W509RX

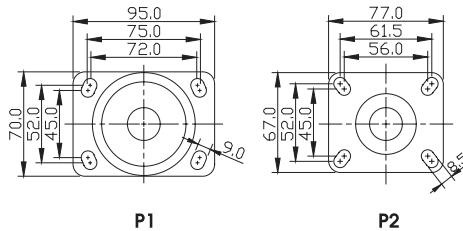

Pressed steel, double ballrace swivel yoke, zinc-chromatized finish

Option: Bright chrome plated finish is also available, add suffix "-CR" to Catis code, e.g. Y580XP1/W503U-CR



TB/A Total locking brake

Total Lock system locks both swivel head and wheel simultaneously for secure parking. Integrated ON/OFF Nylon brake pedals for easy and quiet operation.



DB/A Directional locking brake

Directional Lock permits free wheel rotation while swivel head remains locked, an easy way to keep equipment traveling straight. Integrated ON/OFF Nylon brake pedals for easy and quiet operation. Release pedal in green color.

P Top Plate Fitting



PM Wheel Solid nylon wheel

Brake type	mm	mm		mm	mm	mm	mm	mm	mm	kg	Code
DB/A Dir. locking brake	100	32		95 x 70	75 x 52 / 72 x 45	9.0	40.5	135.0	80		Y480XDP1/W409RX
	100	32		77 x 67	61.5 x 52 / 56 x 45	8.5	40.5	135.0	80		Y480XDP2/W409RX
	125	32		95 x 70	75 x 52 / 72 x 45	9.0	39.0	161.0	100		Y580XDP1/W509RX
	125	32		77 x 67	61.5 x 52 / 56 x 45	8.5	39.0	161.0	100		Y580XDP2/W509RX
Non-brake Free swivel	75	32		95 x 70	75 x 52 / 72 x 45	9.0	33.0	107.0	50		Y381P1/W309RX
	75	32		77 x 67	61.5 x 52 / 56 x 45	8.5	33.0	107.0	50		Y381P2/W309RX
	75	32		105 x 80	85 x 60 / 75 x 60	10.0	33.0	107.0	50		Y381P3/W309RX
	100	32		95 x 70	75 x 52 / 72 x 45	9.0	40.5	135.0	80		Y481P1/W409RX
	100	32		77 x 67	61.5 x 52 / 56 x 45	8.5	40.5	135.0	80		Y481P2/W409RX
	100	32		105 x 80	85 x 60 / 75 x 60	10.0	40.5	135.0	80		Y481P3/W409RX
	125	32		95 x 70	75 x 52 / 72 x 45	9.0	39.0	161.0	100		Y581P1/W509RX
	125	32		77 x 67	61.5 x 52 / 56 x 45	8.5	39.0	161.0	100		Y581P2/W509RX
	125	32		105 x 80	85 x 60 / 75 x 60	10.0	39.0	161.0	100		Y581P3/W509RX

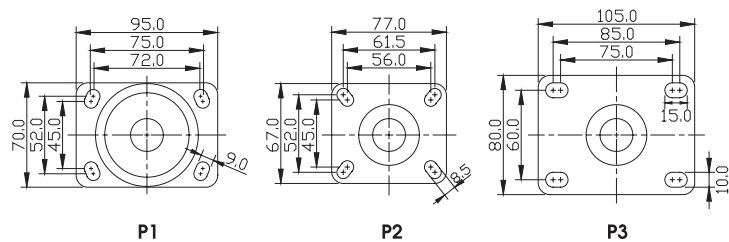

















TB Total locking brake
 Total Lock system simultaneously locks both swivel head and wheel for a secure parking.
 Zinc-alloy brake pedal.

P Top Plate Fitting



PM Wheel Solid nylon wheel

Brake type	 mm	 mm		 mm	 mm	 mm	 mm	 kg	Code
Non-brake Fixed	75	32		95 x 77	75 x 52 / 72 x 45	9.0	107.0	50	Y382P1/W309RX
	100	32		95 x 77	75 x 52 / 72 x 45	9.0	135.0	80	Y482P1/W409RX
	125	32		95 x 77	75 x 52 / 72 x 45	9.0	161.0	100	Y582P1/W509RX
Non-brake Fixed	75	32		67 x 77	52 x 61.5 / 45 x 56	8.5	107.0	50	Y385P2/W309RX
	100	32		67 x 77	52 x 61.5 / 45 x 56	8.5	135.0	80	Y485P2/W409RX
	125	32		67 x 77	52 x 61.5 / 45 x 56	8.5	161.0	100	Y585P2/W509RX
Non-brake Fixed	100	32		105 x 80	85 x 60 / 75 x 60	10.0	135.0	80	Y448P3/W409RX
	125	32		105 x 80	85 x 60 / 75 x 60	10.0	161.0	100	Y548P3/W509RX

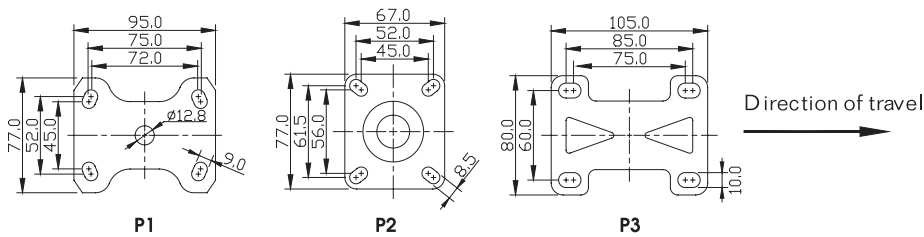

Pressed steel, double ballrace swivel yoke, zinc-chromatized finish

Option: Bright chrome plated finish is also available, add suffix "-CR" to Catis code, e.g. Y580XP1/W503U-CR



TB/A Total locking brake

Total Lock system locks both swivel head and wheel simultaneously for secure parking. Integrated ON/OFF Nylon brake pedals for easy and quiet operation.



DB/A Directional locking brake

Directional Lock permits free wheel rotation while swivel head remains locked, an easy way to keep equipment traveling straight. Integrated ON/OFF Nylon brake pedals for easy and quiet operation. Release pedal in green color.

P Top Plate Fitting



PP Wheel Solid polypropylene wheel

Brake type	mm	mm	mm	mm	mm	mm	mm	mm	kg	Code
TB/A Total locking brake	75	32		95 x 70	75 x 52 / 72 x 45	9.0	33.0	107.0	50	Y380XP1/W310RX
	75	32		77 x 67	61.5 x 52 / 56 x 45	8.5	33.0	107.0	50	Y380XP2/W310RX
	100	32		95 x 70	75 x 52 / 72 x 45	9.0	40.5	135.0	80	Y480XP1/W410RX
	100	32		77 x 67	61.5 x 52 / 56 x 45	8.5	40.5	135.0	80	Y480XP2/W410RX
	125	32		95 x 70	75 x 52 / 72 x 45	9.0	39.0	161.0	100	Y580XP1/W510RX
	125	32		77 x 67	61.5 x 52 / 56 x 45	8.5	39.0	161.0	100	Y580XP2/W510RX
TB/B Total locking brake	75	32		95 x 70	75 x 52 / 72 x 45	9.0	41.0	107.0	50	Y380P1/W310RX
	75	32		77 x 67	61.5 x 52 / 56 x 45	8.5	41.0	107.0	50	Y380P2/W310RX
	100	32		95 x 70	75 x 52 / 72 x 45	9.0	40.5	135.0	80	Y480P1/W410RX
	100	32		77 x 67	61.5 x 52 / 56 x 45	8.5	40.5	135.0	80	Y480P2/W410RX
	125	32		95 x 70	75 x 52 / 72 x 45	9.0	39.0	161.0	100	Y580P1/W510RX
	125	32		77 x 67	61.5 x 52 / 56 x 45	8.5	39.0	161.0	100	Y580P2/W510RX
DB/A Dir. locking brake	100	32		95 x 70	75 x 52 / 72 x 45	9.0	40.5	135.0	80	Y480XD1/W410RX
	100	32		77 x 67	61.5 x 52 / 56 x 45	8.5	40.5	135.0	80	Y480XD2/W410RX
	125	32		95 x 70	75 x 52 / 72 x 45	9.0	39.0	161.0	100	Y580XD1/W510RX
	125	32		77 x 67	61.5 x 52 / 56 x 45	8.5	39.0	161.0	100	Y580XD2/W510RX

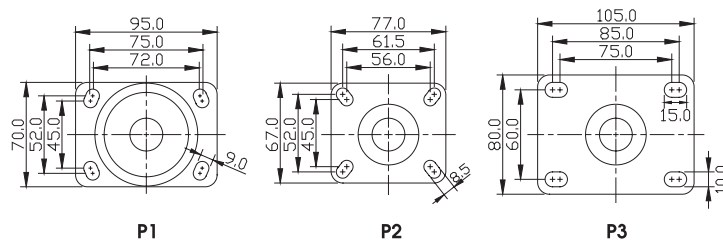



TB Total locking brake
 Total Lock system simultaneously locks both swivel head and wheel for a secure parking.
 Zinc-alloy brake pedal.

P Top Plate Fitting

PP Wheel Solid polypropylene wheel

Brake type	mm	mm		mm	mm	mm	mm	mm	kg	Code
Non-brake Free swivel	75	32		95 x 70	75 x 52 / 72 x 45	9.0	33.0	107.0	50	Y381P1/W310RX
	75	32		77 x 67	61.5 x 52 / 56 x 45	8.5	33.0	107.0	50	Y381P2/W310RX
	75	32		105 x 80	85 x 60 / 75 x 60	10.0	33.0	107.0	50	Y381P3/W310RX
	100	32		95 x 70	75 x 52 / 72 x 45	9.0	40.5	135.0	80	Y481P1/W410RX
	100	32		77 x 67	61.5 x 52 / 56 x 45	8.5	40.5	135.0	80	Y481P2/W410RX
	100	32		105 x 80	85 x 60 / 75 x 60	10.0	40.5	135.0	80	Y481P3/W410RX
	125	32		95 x 70	75 x 52 / 72 x 45	9.0	39.0	161.0	100	Y581P1/W510RX
	125	32		77 x 67	61.5 x 52 / 56 x 45	8.5	39.0	161.0	100	Y581P2/W510RX
	125	32		105 x 80	85 x 60 / 75 x 60	10.0	39.0	161.0	100	Y581P3/W510RX



Brake type	mm	mm		mm	mm	mm	mm	kg	Code
Non-brake Fixed	75	32		95 x 77	75 x 52 / 72 x 45	9.0	107.0	50	Y382P1/W310RX
	100	32		95 x 77	75 x 52 / 72 x 45	9.0	135.0	80	Y482P1/W410RX
	125	32		95 x 77	75 x 52 / 72 x 45	9.0	161.0	100	Y582P1/W510RX
	75	32		67 x 77	52 x 61.5 / 45 x 56	8.5	107.0	50	Y385P2/W310RX
	100	32		67 x 77	52 x 61.5 / 45 x 56	8.5	135.0	80	Y485P2/W410RX
	125	32		67 x 77	52 x 61.5 / 45 x 56	8.5	161.0	100	Y585P2/W510RX
	100	32		105 x 80	85 x 60 / 75 x 60	10.0	135.0	80	Y448P3/W410RX
	125	32		105 x 80	85 x 60 / 75 x 60	10.0	161.0	100	Y548P3/W510RX

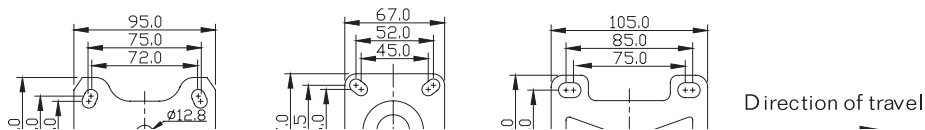

Pressed steel, double ballrace swivel yoke, zinc-chromatized finish

Option: Bright chrome plated finish is also available, add suffix "-CR" to Catis code, e.g. Y580XP1/W503U-CR



TB/A Total locking brake

Total Lock system locks both swivel head and wheel simultaneously for secure parking. Integrated ON/OFF Nylon brake pedals for easy and quiet operation.



DB/A Directional locking brake

Directional Lock permits free wheel rotation while swivel head remains locked, an easy way to keep equipment traveling straight. Integrated ON/OFF Nylon brake pedals for easy and quiet operation. Release pedal in green color.

R Round Stem



PRB Wheel Plastic hub, grey color elastic rubber tire

Brake type	mm	mm		mm	mm	mm	mm	mm	mm	mm	kg	Code
TB/A Total locking brake	100	32		22.0	45.0	19.0	M8x1.25	40.5	135.0	80		Y480XR8/W424
	100	32		28.0	45.0	19.0	M8x1.25	40.5	135.0	80		Y480XR9/W424
	100	32		25.6	45.0	19.0	M8x1.25	40.5	135.0	80		Y480XR16/W424
	125	32		22.0	45.0	19.0	M8x1.25	39.0	161.0	100		Y580XR8/W524
	125	32		28.0	45.0	19.0	M8x1.25	39.0	161.0	100		Y580XR9/W524
	125	32		25.6	45.0	19.0	M8x1.25	39.0	161.0	100		Y580XR16/W524
	150	32		22.0	45.0	19.0	M8x1.25	50.0	189.5	100		Y680XR8/W624
	150	32		28.0	45.0	19.0	M8x1.25	50.0	189.5	100		Y680XR9/W624
	150	32		25.6	45.0	19.0	M8x1.25	50.0	189.5	100		Y680XR16/W624
TB/B Total locking brake	100	32		22.0	45.0	19.0	M8x1.25	40.5	135.0	80		Y480R8/W424
	100	32		28.0	45.0	19.0	M8x1.25	40.5	135.0	80		Y480R9/W424
	100	32		25.6	45.0	19.0	M8x1.25	40.5	135.0	80		Y480R16/W424
	125	32		22.0	45.0	19.0	M8x1.25	39.0	161.0	100		Y580R8/W524
	125	32		28.0	45.0	19.0	M8x1.25	39.0	161.0	100		Y580R9/W524
	125	32		25.6	45.0	19.0	M8x1.25	39.0	161.0	100		Y580R16/W524
	150	32		22.0	45.0	19.0	M8x1.25	46.5	189.5	100		Y680R8/W624
	150	32		28.0	45.0	19.0	M8x1.25	46.5	189.5	100		Y680R9/W624
	150	32		25.6	45.0	19.0	M8x1.25	46.5	189.5	100		Y680R16/W624





TB Total locking brake
 Total Lock system simultaneously locks both swivel head and wheel for a secure parking.
 Zinc-alloy brake pedal.

R Round Stem

PRB Wheel Plastic hub, grey color elastic rubber tire

Brake type	mm	mm		mm	mm	mm	mm	mm	mm	kg	Code
DB Dir. locking brake	100	32		22.0	45.0	19.0	M8x1.25	40.5	135.0	80	Y480XDR8/W424
	100	32		28.0	45.0	19.0	M8x1.25	40.5	135.0	80	Y480XDR9/W424
	100	32		25.6	45.0	19.0	M8x1.25	40.5	135.0	80	Y480XDR16/W424
	125	32		22.0	45.0	19.0	M8x1.25	39.0	161.0	100	Y580XDR8/W524
	125	32		28.0	45.0	19.0	M8x1.25	39.0	161.0	100	Y580XDR9/W524
	125	32		25.6	45.0	19.0	M8x1.25	39.0	161.0	100	Y580XDR16/W524
	150	32		22.0	45.0	19.0	M8x1.25	50.0	189.5	100	Y680XDR8/W624
	150	32		28.0	45.0	19.0	M8x1.25	50.0	189.5	100	Y680XDR9/W624
	150	32		25.6	45.0	19.0	M8x1.25	50.0	189.5	100	Y680XDR16/W624
Non-brake Free swivel	100	32		22.0	45.0	19.0	M8x1.25	40.5	135.0	80	Y481R8/W424
	100	32		28.0	45.0	19.0	M8x1.25	40.5	135.0	80	Y481R9/W424
	100	32		25.6	45.0	19.0	M8x1.25	40.5	135.0	80	Y481R16/W424
	125	32		22.0	45.0	19.0	M8x1.25	39.0	161.0	100	Y581R8/W524
	125	32		28.0	45.0	19.0	M8x1.25	39.0	161.0	100	Y581R9/W524
	125	32		25.6	45.0	19.0	M8x1.25	39.0	161.0	100	Y581R16/W524
	150	32		22.0	45.0	19.0	M8x1.25	50.0	189.5	100	Y681R8/W624
	150	32		28.0	45.0	19.0	M8x1.25	50.0	189.5	100	Y681R9/W624
	150	32		25.6	45.0	19.0	M8x1.25	50.0	189.5	100	Y681R16/W624



Pressed steel, double ballrace swivel yoke, zinc-chromatized finish

Option: Bright chrome plated finish is also available, add suffix "-CR" to Catis code, e.g. Y580XP1/W503U-CR



TB/A Total locking brake
Total Lock system locks both swivel head and wheel simultaneously for secure parking. Integrated ON/OFF Nylon brake pedals for easy and quiet operation.



DB/A Directional locking brake
Directional Lock permits free wheel rotation while swivel head remains locked, an easy way to keep equipment traveling straight. Integrated ON/OFF Nylon brake pedals for easy and quiet operation. Release pedal in green color.

R Round Stem

SRB Wheel Pressed steel hub, grey color elastic rubber tire

Brake type	mm	mm		mm	mm	mm	mm	mm	mm	mm	kg	Code
TB/A Total locking brake	100	32		22.0	45.0	19.0	M8x1.25	40.5	135.0	80		Y480XR8/W423
	100	32		28.0	45.0	19.0	M8x1.25	40.5	135.0	80		Y480XR9/W423
	100	32		25.6	45.0	19.0	M8x1.25	40.5	135.0	80		Y480XR16/W423
	125	32		22.0	45.0	19.0	M8x1.25	39.0	161.0	100		Y580XR8/W523
	125	32		28.0	45.0	19.0	M8x1.25	39.0	161.0	100		Y580XR9/W523
	125	32		25.6	45.0	19.0	M8x1.25	39.0	161.0	100		Y580XR16/W523
	150	32		22.0	45.0	19.0	M8x1.25	50.0	189.5	100		Y680XR8/W623
	150	32		28.0	45.0	19.0	M8x1.25	50.0	189.5	100		Y680XR9/W623
	150	32		25.6	45.0	19.0	M8x1.25	50.0	189.5	100		Y680XR16/W623
TB/B Total locking brake	100	32		22.0	45.0	19.0	M8x1.25	40.5	135.0	80		Y480R8/W423
	100	32		28.0	45.0	19.0	M8x1.25	40.5	135.0	80		Y480R9/W423
	100	32		25.6	45.0	19.0	M8x1.25	40.5	135.0	80		Y480R16/W423
	125	32		22.0	45.0	19.0	M8x1.25	39.0	161.0	100		Y580R8/W523
	125	32		28.0	45.0	19.0	M8x1.25	39.0	161.0	100		Y580R9/W523
	125	32		25.6	45.0	19.0	M8x1.25	39.0	161.0	100		Y580R16/W523
	150	32		22.0	45.0	19.0	M8x1.25	46.5	189.5	100		Y680R8/W623
	150	32		28.0	45.0	19.0	M8x1.25	46.5	189.5	100		Y680R9/W623
	150	32		25.6	45.0	19.0	M8x1.25	46.5	189.5	100		Y680R16/W623





TB Total locking brake
 Total Lock system simultaneously locks both swivel head and wheel for a secure parking.
 Zinc-alloy brake pedal.

R Round Stem

SRB Wheel **Pressed steel hub, grey color elastic rubber tire**

Brake type	mm	mm		mm	mm	mm	mm	mm	mm	kg	Code
DB Dir. locking brake	100	32		22.0	45.0	19.0	M8x1.25	40.5	135.0	80	Y480XDR8/W423
	100	32		28.0	45.0	19.0	M8x1.25	40.5	135.0	80	Y480XDR9/W423
	100	32		25.6	45.0	19.0	M8x1.25	40.5	135.0	80	Y480XDR16/W423
	125	32		22.0	45.0	19.0	M8x1.25	39.0	161.0	100	Y580XDR8/W523
	125	32		28.0	45.0	19.0	M8x1.25	39.0	161.0	100	Y580XDR9/W523
	125	32		25.6	45.0	19.0	M8x1.25	39.0	161.0	100	Y580XDR16/W523
	150	32		22.0	45.0	19.0	M8x1.25	50.0	189.5	100	Y680XDR8/W623
	150	32		28.0	45.0	19.0	M8x1.25	50.0	189.5	100	Y680XDR9/W623
	150	32		25.6	45.0	19.0	M8x1.25	50.0	189.5	100	Y680XDR16/W623
Non-brake Free swivel	100	32		22.0	45.0	19.0	M8x1.25	40.5	135.0	80	Y481R8/W423
	100	32		28.0	45.0	19.0	M8x1.25	40.5	135.0	80	Y481R9/W423
	100	32		25.6	45.0	19.0	M8x1.25	40.5	135.0	80	Y481R16/W423
	125	32		22.0	45.0	19.0	M8x1.25	39.0	161.0	100	Y581R8/W523
	125	32		28.0	45.0	19.0	M8x1.25	39.0	161.0	100	Y581R9/W523
	125	32		25.6	45.0	19.0	M8x1.25	39.0	161.0	100	Y581R16/W523
	150	32		22.0	45.0	19.0	M8x1.25	50.0	189.5	100	Y681R8/W623
	150	32		28.0	45.0	19.0	M8x1.25	50.0	189.5	100	Y681R9/W623
	150	32		25.6	45.0	19.0	M8x1.25	50.0	189.5	100	Y681R16/W623



SRB/BKAS Wheel **Conductive wheels are also available**

		Code
Pressed steel hub and threadguards, zinc-chromatized finish, black color conductive rubber tire	100 x 32mm	W423-BKAS
	125 x 32mm	W523-BKAS



Pressed steel, double ballrace swivel yoke, zinc-chromatized finish

Option: Bright chrome plated finish is also available, add suffix "-CR" to Catis code, e.g. Y580XP1/W503U-CR



TB/A Total locking brake

Total Lock system locks both swivel head and wheel simultaneously for secure parking. Integrated ON/OFF Nylon brake pedals for easy and quiet operation.



DB/A Directional locking brake

Directional Lock permits free wheel rotation while swivel head remains locked, an easy way to keep equipment traveling straight. Integrated ON/OFF Nylon brake pedals for easy and quiet operation. Release pedal in green color.

R Round Stem



TPR Wheel

Plastic hub, grey color thermoplastic rubber tire

Brake type	mm	mm		mm	mm	mm	mm	mm	mm	mm	kg	Code
TB/A Total locking brake	125	25		22.0	45.0	19.0	M8x1.25	38.5	161.0	70		Y560R8/W512
	125	25		28.0	45.0	19.0	M8x1.25	38.5	161.0	70		Y560R9/W512
	125	25		25.6	45.0	19.0	M8x1.25	38.5	161.0	70		Y560R16/W512
	100	32		22.0	45.0	19.0	M8x1.25	40.5	135.0	80		Y480XR8/W403
	100	32		28.0	45.0	19.0	M8x1.25	40.5	135.0	80		Y480XR9/W403
	100	32		25.6	45.0	19.0	M8x1.25	40.5	135.0	80		Y480XR16/W403
	125	32		22.0	45.0	19.0	M8x1.25	39.0	161.0	100		Y580XR8/W503
	125	32		28.0	45.0	19.0	M8x1.25	39.0	161.0	100		Y580XR9/W503
	125	32		25.6	45.0	19.0	M8x1.25	39.0	161.0	100		Y580XR16/W503
	125	32		22.0	45.0	19.0	M8x1.25	39.0	161.0	100		Y580XR8/W503U
	125	32		28.0	45.0	19.0	M8x1.25	39.0	161.0	100		Y580XR9/W503U
	125	32		25.6	45.0	19.0	M8x1.25	39.0	161.0	100		Y580XR16/W503U
150	32		22.0	45.0	19.0	M8x1.25	50.0	189.5	100		Y680XR8/W603U	
150	32		28.0	45.0	19.0	M8x1.25	50.0	189.5	100		Y680XR9/W603U	
150	32		25.6	45.0	19.0	M8x1.25	50.0	189.5	100		Y680XR16/W603U	



























TB Total locking brake
 Total Lock system simultaneously locks both swivel head and wheel for a secure parking.
 Zinc-alloy brake pedal.

R Round Stem

TPR Wheel Plastic hub, grey color thermoplastic rubber tire

Brake type	 mm	 mm		 mm	 mm	 mm	 mm	 mm	 mm	 kg	Code
TB Total locking brake	100	32		22.0	45.0	19.0	M8x1.25	40.5	135.0	80	Y480R8/W403
	100	32		28.0	45.0	19.0	M8x1.25	40.5	135.0	80	Y480R9/W403
	100	32		25.6	45.0	19.0	M8x1.25	40.5	135.0	80	Y480R16/W403
	125	32		22.0	45.0	19.0	M8x1.25	39.0	161.0	100	Y580R8/W503
	125	32		28.0	45.0	19.0	M8x1.25	39.0	161.0	100	Y580R9/W503
	125	32		25.6	45.0	19.0	M8x1.25	39.0	161.0	100	Y580R16/W503
	125	32		22.0	45.0	19.0	M8x1.25	39.0	161.0	100	Y580R8/W503U
	125	32		28.0	45.0	19.0	M8x1.25	39.0	161.0	100	Y580R9/W503U
	125	32		25.6	45.0	19.0	M8x1.25	39.0	161.0	100	Y580R16/W503U
	150	32		22.0	45.0	19.0	M8x1.25	46.5	189.5	100	Y680R8/W603U
	150	32		28.0	45.0	19.0	M8x1.25	46.5	189.5	100	Y680R9/W603U
	150	32		25.6	45.0	19.0	M8x1.25	46.5	189.5	100	Y680R16/W603U



Pressed steel, double ballrace swivel yoke, zinc-chromatized finish

Option: Bright chrome plated finish is also available, add suffix "-CR" to Catis code, e.g. Y580XP1/W503U-CR



TB Total locking brake

Total Lock system locks both swivel head and wheel simultaneously for secure parking. Integrated ON/OFF Nylon brake pedals for easy and quiet operation.



DB Directional locking brake

Directional Lock permits free wheel rotation while swivel head remains locked, an easy way to keep equipment traveling straight. Integrated ON/OFF Nylon brake pedals for easy and quiet operation. Release pedal in green color.

R Round Stem



TPR Wheel

Plastic hub, grey color thermoplastic rubber tire

Brake type	mm	mm		mm	mm	mm	mm	mm	mm	kg	Code
DB Dir. locking brake	100	32		22.0	45.0	19.0	M8x1.25	40.5	135.0	80	Y480XDR8/W403
	100	32		28.0	45.0	19.0	M8x1.25	40.5	135.0	80	Y480XDR9/W403
	100	32		25.6	45.0	19.0	M8x1.25	40.5	135.0	80	Y480XDR16/W403
	125	32		22.0	45.0	19.0	M8x1.25	39.0	161.0	100	Y580XDR8/W503
	125	32		28.0	45.0	19.0	M8x1.25	39.0	161.0	100	Y580XDR9/W503
	125	32		25.6	45.0	19.0	M8x1.25	39.0	161.0	100	Y580XDR16/W503
	125	32		22.0	45.0	19.0	M8x1.25	39.0	161.0	100	Y580XDR8/W503U
	125	32		28.0	45.0	19.0	M8x1.25	39.0	161.0	100	Y580XDR9/W503U
	125	32		25.6	45.0	19.0	M8x1.25	39.0	161.0	100	Y580XDR16/W503U
	150	32		22.0	45.0	19.0	M8x1.25	50.0	189.5	100	Y680XDR8/W603U
	150	32		28.0	45.0	19.0	M8x1.25	50.0	189.5	100	Y680XDR9/W603U
	150	32		25.6	45.0	19.0	M8x1.25	50.0	189.5	100	Y680XDR16/W603U





TLB Total locking brake
 Total Lock system simultaneously locks both swivel head and wheel for a secure parking.
 Zinc-alloy brake pedal.

R Round Stem

TPR Wheel Plastic hub, grey color thermoplastic rubber tire

Brake type	mm	mm		mm	mm	mm	mm	mm	mm	kg	Code
Non-brake Free swivel	125	25		22.0	45.0	19.0	M8x1.25	38.5	161.0	70	Y561R8/W512
	125	25		28.0	45.0	19.0	M8x1.25	38.5	161.0	70	Y561R9/W512
	125	25		25.6	45.0	19.0	M8x1.25	38.5	161.0	70	Y561R16/W512
	100	32		22.0	45.0	19.0	M8x1.25	40.5	135.0	80	Y481R8/W403
	100	32		28.0	45.0	19.0	M8x1.25	40.5	135.0	80	Y481R9/W403
	100	32		25.6	45.0	19.0	M8x1.25	40.5	135.0	80	Y481R16/W403
	125	32		22.0	45.0	19.0	M8x1.25	39.0	161.0	100	Y581R8/W503
	125	32		28.0	45.0	19.0	M8x1.25	39.0	161.0	100	Y581R9/W503
	125	32		25.6	45.0	19.0	M8x1.25	39.0	161.0	100	Y581R16/W503
	125	32		22.0	45.0	19.0	M8x1.25	39.0	161.0	100	Y581R8/W503U
	125	32		28.0	45.0	19.0	M8x1.25	39.0	161.0	100	Y581R9/W503U
	125	32		25.6	45.0	19.0	M8x1.25	39.0	161.0	100	Y581R16/W503U
150	32		22.0	45.0	19.0	M8x1.25	50.0	189.5	100	Y681R8/W603U	
150	32		28.0	45.0	19.0	M8x1.25	50.0	189.5	100	Y681R9/W603U	
150	32		25.6	45.0	19.0	M8x1.25	50.0	189.5	100	Y681R16/W603U	



TPR/AS Wheel Conductive wheels are also available

	Code	
Plastic hub and threadguards, grey color conductive thermoplastic rubber tire	075 x 25mm	W303CX-AS*
	100 x 32mm	W403-AS
	125 x 32mm	W503-AS
	150 x 32mm	W603U-AS



*Wheel with metal threadguards (see P020)

Electrical Resistance $\leq 10^4 \Omega$

Pressed steel, double ballrace swivel yoke, zinc-chromatized finish

Option: Bright chrome plated finish is also available, add suffix "-CR" to Catis code, e.g. Y580XP1/W503U-CR



TB/A Total locking brake

Total Lock system locks both swivel head and wheel simultaneously for secure parking. Integrated ON/OFF Nylon brake pedals for easy and quiet operation.



DB/A Directional locking brake

Directional Lock permits free wheel rotation while swivel head remains locked, an easy way to keep equipment traveling straight. Integrated ON/OFF Nylon brake pedals for easy and quiet operation. Release pedal in green color.

R Round Stem



TPU Wheel Plastic hub, grey color polyurethane tire

Brake type	mm	mm		mm	mm	mm	mm	mm	mm	kg	Code
TB/A Total locking brake	100	32		22.0	45.0	19.0	M8x1.25	40.5	135.0	80	Y480XR8/W400E
	100	32		28.0	45.0	19.0	M8x1.25	40.5	135.0	80	Y480XR9/W400E
	100	32		25.6	45.0	19.0	M8x1.25	40.5	135.0	80	Y480XR16/W400E
	125	32		22.0	45.0	19.0	M8x1.25	39.0	161.0	100	Y580XR8/W500E
	125	32		28.0	45.0	19.0	M8x1.25	39.0	161.0	100	Y580XR9/W500E
	125	32		25.6	45.0	19.0	M8x1.25	39.0	161.0	100	Y580XR16/W500E
	150	32		22.0	45.0	19.0	M8x1.25	50.0	189.5	100	Y680XR8/W600E
	150	32		28.0	45.0	19.0	M8x1.25	50.0	189.5	100	Y680XR9/W600E
	150	32		25.6	45.0	19.0	M8x1.25	50.0	189.5	100	Y680XR16/W600E
TB/B Total locking brake	100	32		22.0	45.0	19.0	M8x1.25	40.5	135.0	80	Y480R8/W400E
	100	32		28.0	45.0	19.0	M8x1.25	40.5	135.0	80	Y480R9/W400E
	100	32		25.6	45.0	19.0	M8x1.25	40.5	135.0	80	Y480R16/W400E
	125	32		22.0	45.0	19.0	M8x1.25	39.0	161.0	100	Y580R8/W500E
	125	32		28.0	45.0	19.0	M8x1.25	39.0	161.0	100	Y580R9/W500E
	125	32		25.6	45.0	19.0	M8x1.25	39.0	161.0	100	Y580R16/W500E
	150	32		22.0	45.0	19.0	M8x1.25	46.5	189.5	100	Y680R8/W600E
	150	32		28.0	45.0	19.0	M8x1.25	46.5	189.5	100	Y680R9/W600E
	150	32		25.6	45.0	19.0	M8x1.25	46.5	189.5	100	Y680R16/W600E





TB Total locking brake
 Total Lock system simultaneously locks both swivel head and wheel for a secure parking.
 Zinc-alloy brake pedal.

R Round Stem



TPU Wheel Plastic hub, grey color polyurethane tire

Brake type	mm	mm		mm	mm	mm	mm	mm	mm	kg	Code
DB Dir. locking brake	100	32		22.0	45.0	19.0	M8x1.25	40.5	135.0	80	Y480XDR8/W400E
	100	32		28.0	45.0	19.0	M8x1.25	40.5	135.0	80	Y480XDR9/W400E
	100	32		25.6	45.0	19.0	M8x1.25	40.5	135.0	80	Y480XDR16/W400E
	125	32		22.0	45.0	19.0	M8x1.25	39.0	161.0	100	Y580XDR8/W500E
	125	32		28.0	45.0	19.0	M8x1.25	39.0	161.0	100	Y580XDR9/W500E
	125	32		25.6	45.0	19.0	M8x1.25	39.0	161.0	100	Y580XDR16/W500E
	150	32		22.0	45.0	19.0	M8x1.25	50.0	189.5	100	Y680XDR8/W600E
	150	32		28.0	45.0	19.0	M8x1.25	50.0	189.5	100	Y680XDR9/W600E
	150	32		25.6	45.0	19.0	M8x1.25	50.0	189.5	100	Y680XDR16/W600E
Non-brake Free swivel	100	32		22.0	45.0	19.0	M8x1.25	40.5	135.0	80	Y481R8/W400E
	100	32		28.0	45.0	19.0	M8x1.25	40.5	135.0	80	Y481R9/W400E
	100	32		25.6	45.0	19.0	M8x1.25	40.5	135.0	80	Y481R16/W400E
	125	32		22.0	45.0	19.0	M8x1.25	39.0	161.0	100	Y581R8/W500E
	125	32		28.0	45.0	19.0	M8x1.25	39.0	161.0	100	Y581R9/W500E
	125	32		25.6	45.0	19.0	M8x1.25	39.0	161.0	100	Y581R16/W500E
	150	32		22.0	45.0	19.0	M8x1.25	50.0	189.5	100	Y681R8/W600E
	150	32		28.0	45.0	19.0	M8x1.25	50.0	189.5	100	Y681R9/W600E
	150	32		25.6	45.0	19.0	M8x1.25	50.0	189.5	100	Y681R16/W600E



Pressed steel, double ballrace swivel yoke, zinc-chromatized finish

Option: Bright chrome plated finish is also available, add suffix "-CR" to Catis code, e.g. Y580XP1/W503U-CR



TB/A Total locking brake

Total Lock system locks both swivel head and wheel simultaneously for secure parking. Integrated ON/OFF Nylon brake pedals for easy and quiet operation.



DB/A Directional locking brake

Directional Lock permits free wheel rotation while swivel head remains locked, an easy way to keep equipment traveling straight. Integrated ON/OFF Nylon brake pedals for easy and quiet operation. Release pedal in green color.

R Round Stem



PM Wheel Solid nylon wheel

Brake type	mm	mm		mm	mm	mm	mm	mm	mm	kg	Code
TB/A Total locking brake	100	32		22.0	45.0	19.0	M8x1.25	40.5	135.0	80	Y480XR8/W409RX
	100	32		28.0	45.0	19.0	M8x1.25	40.5	135.0	80	Y480XR9/W409RX
	100	32		25.6	45.0	19.0	M8x1.25	40.5	135.0	80	Y480XR16/W409RX
	125	32		22.0	45.0	19.0	M8x1.25	39.0	161.0	100	Y580XR8/W509RX
	125	32		28.0	45.0	19.0	M8x1.25	39.0	161.0	100	Y580XR9/W509RX
	125	32		25.6	45.0	19.0	M8x1.25	39.0	161.0	100	Y580XR16/W509RX
TB/B Total locking brake	100	32		22.0	45.0	19.0	M8x1.25	40.5	135.0	80	Y480R8/W409RX
	100	32		28.0	45.0	19.0	M8x1.25	40.5	135.0	80	Y480R9/W409RX
	100	32		25.6	45.0	19.0	M8x1.25	40.5	135.0	80	Y480R16/W409RX
	125	32		22.0	45.0	19.0	M8x1.25	39.0	161.0	100	Y580R8/W509RX
	125	32		28.0	45.0	19.0	M8x1.25	39.0	161.0	100	Y580R9/W509RX
	125	32		25.6	45.0	19.0	M8x1.25	39.0	161.0	100	Y580R16/W509RX



























TLB Total locking brake
 Total Lock system simultaneously locks both swivel head and wheel for a secure parking.
 Zinc-alloy brake pedal.

R Round Stem



PM Wheel Solid nylon wheel

Brake type	 mm	 mm		 mm	 mm	 mm	 mm	 mm	 mm	 kg	Code
DB Dir. locking brake	100	32		22.0	45.0	19.0	M8x1.25	40.5	135.0	80	Y480XDR8/W409RX
	100	32		28.0	45.0	19.0	M8x1.25	40.5	135.0	80	Y480XDR9/W409RX
	100	32		25.6	45.0	19.0	M8x1.25	40.5	135.0	80	Y480XDR16/W409RX
	125	32		22.0	45.0	19.0	M8x1.25	39.0	161.0	100	Y580XDR8/W509RX
	125	32		28.0	45.0	19.0	M8x1.25	39.0	161.0	100	Y580XDR9/W509RX
	125	32		25.6	45.0	19.0	M8x1.25	39.0	161.0	100	Y580XDR16/W509RX
Non-brake Free swivel	100	32		22.0	45.0	19.0	M8x1.25	40.5	135.0	80	Y481R8/W409RX
	100	32		28.0	45.0	19.0	M8x1.25	40.5	135.0	80	Y481R9/W409RX
	100	32		25.6	45.0	19.0	M8x1.25	40.5	135.0	80	Y481R16/W409RX
	125	32		22.0	45.0	19.0	M8x1.25	39.0	161.0	100	Y581R8/W509RX
	125	32		28.0	45.0	19.0	M8x1.25	39.0	161.0	100	Y581R9/W509RX
	125	32		25.6	45.0	19.0	M8x1.25	39.0	161.0	100	Y581R16/W509RX



Pressed steel, double ballrace swivel yoke, zinc-chromatized finish

Option: Bright chrome plated finish is also available, add suffix "-CR" to Catis code, e.g. Y580XP1/W503U-CR



TB/A Total locking brake

Total Lock system locks both swivel head and wheel simultaneously for secure parking. Integrated ON/OFF Nylon brake pedals for easy and quiet operation.



DB/A Directional locking brake

Directional Lock permits free wheel rotation while swivel head remains locked, an easy way to keep equipment traveling straight. Integrated ON/OFF Nylon brake pedals for easy and quiet operation. Release pedal in green color.

R Round Stem



PP Wheel Solid polypropylene wheel

Brake type	mm	mm		mm	mm	mm	mm	mm	mm	kg	Code
TB/A Total locking brake	100	32		22.0	45.0	19.0	M8x1.25	40.5	135.0	80	Y480XR8/W410RX
	100	32		28.0	45.0	19.0	M8x1.25	40.5	135.0	80	Y480XR9/W410RX
	100	32		25.6	45.0	19.0	M8x1.25	40.5	135.0	80	Y480XR16/W410RX
	125	32		22.0	45.0	19.0	M8x1.25	39.0	161.0	100	Y580XR8/W510RX
	125	32		28.0	45.0	19.0	M8x1.25	39.0	161.0	100	Y580XR9/W510RX
	125	32		25.6	45.0	19.0	M8x1.25	39.0	161.0	100	Y580XR16/W510RX
TB/B Total locking brake	100	32		22.0	45.0	19.0	M8x1.25	40.5	135.0	80	Y480R8/W410RX
	100	32		28.0	45.0	19.0	M8x1.25	40.5	135.0	80	Y480R9/W410RX
	100	32		25.6	45.0	19.0	M8x1.25	40.5	135.0	80	Y480R16/W410RX
	125	32		22.0	45.0	19.0	M8x1.25	39.0	161.0	100	Y580R8/W510RX
	125	32		28.0	45.0	19.0	M8x1.25	39.0	161.0	100	Y580R9/W510RX
	125	32		25.6	45.0	19.0	M8x1.25	39.0	161.0	100	Y580R16/W510RX





TB Total locking brake
 Total Lock system simultaneously locks both swivel head and wheel for a secure parking.
 Zinc-alloy brake pedal.

R Round Stem



PP Wheel Solid polypropylene wheel

Brake type	mm	mm		mm	mm	mm	mm	mm	mm	kg	Code
DB Dir. locking brake	100	32		22.0	45.0	19.0	M8x1.25	40.5	135.0	80	Y480XDR8/W410RX
	100	32		28.0	45.0	19.0	M8x1.25	40.5	135.0	80	Y480XDR9/W410RX
	100	32		25.6	45.0	19.0	M8x1.25	40.5	135.0	80	Y480XDR16/W410RX
	125	32		22.0	45.0	19.0	M8x1.25	39.0	161.0	100	Y580XDR8/W510RX
	125	32		28.0	45.0	19.0	M8x1.25	39.0	161.0	100	Y580XDR9/W510RX
	125	32		25.6	45.0	19.0	M8x1.25	39.0	161.0	100	Y580XDR16/W510RX
Non-brake Free swivel	100	32		22.0	45.0	19.0	M8x1.25	40.5	135.0	80	Y481R8/W410RX
	100	32		28.0	45.0	19.0	M8x1.25	40.5	135.0	80	Y481R9/W410RX
	100	32		25.6	45.0	19.0	M8x1.25	40.5	135.0	80	Y481R16/W410RX
	125	32		22.0	45.0	19.0	M8x1.25	39.0	161.0	100	Y581R8/W510RX
	125	32		28.0	45.0	19.0	M8x1.25	39.0	161.0	100	Y581R9/W510RX
	125	32		25.6	45.0	19.0	M8x1.25	39.0	161.0	100	Y581R16/W510RX



Pressed steel, double ballrace swivel yoke, zinc-chromatized finish

Option: Bright chrome plated finish is also available, add suffix *-CR* to Catis code, e.g. Y580XP1/W503U-CR



TB/A Total locking brake

Total Lock system locks both swivel head and wheel simultaneously for secure parking. Integrated ON/OFF Nylon brake pedals for easy and quiet operation.



DB/A Directional locking brake

Directional Lock permits free wheel rotation while swivel head remains locked, an easy way to keep equipment traveling straight. Integrated ON/OFF Nylon brake pedals for easy and quiet operation. Release pedal in green color.

T Threaded Stem Fitting with Hex Base Washer



PRB Wheel Plastic hub, grey color elastic rubber tire

Brake type	mm	mm		mm	mm	mm	mm	kg	Code
TB/A Total locking brake	75	32		1/2-13UNC	1"	33.0	107.0	50	Y380XT2/W324
	75	32		M10 P1.5	25.0	33.0	107.0	50	Y380XT3/W324
	75	32		M12 P1.75	25.0	33.0	107.0	50	Y380XT4/W324
	75	32		M16 P2.0	25.0	33.0	107.0	50	Y380XT5/W324
	75	32		5/8-11UNC	1-1/4"	33.0	107.0	50	Y380XT6/W324
	75	32		1/2-12UNC	1"	33.0	107.0	50	Y380XT7/W324
	75	32		1/2-20UNF	25.0	33.0	107.0	50	Y380XT10/W324
	100	32		1/2-13UNC	1"	40.5	135.0	80	Y480XT2/W424
	100	32		M10 P1.5	25.0	40.5	135.0	80	Y480XT3/W424
	100	32		M12 P1.75	25.0	40.5	135.0	80	Y480XT4/W424
100	32		M16 P2.0	25.0	40.5	135.0	80	Y480XT5/W424	
100	32		5/8-11UNC	1-1/4"	40.5	135.0	80	Y480XT6/W424	
100	32		1/2-12UNC	1"	40.5	135.0	80	Y480XT7/W424	
100	32		1/2-20UNF	25.0	40.5	135.0	80	Y480XT10/W424	
125	32		1/2-13UNC	1"	39.0	161.0	100	Y580XT2/W524	
125	32		M10 P1.5	25.0	39.0	161.0	100	Y580XT3/W524	
125	32		M12 P1.75	25.0	39.0	161.0	100	Y580XT4/W524	
125	32		M16 P2.0	25.0	39.0	161.0	100	Y580XT5/W524	
125	32		5/8-11UNC	1-1/4"	39.0	161.0	100	Y580XT6/W524	
125	32		1/2-12UNC	1"	39.0	161.0	100	Y580XT7/W524	
125	32		1/2-20UNF	25.0	39.0	161.0	100	Y580XT10/W524	













TB/3 Total locking brake
 Total Lock system simultaneously locks both swivel head and wheel for a secure parking.
 Zinc-alloy brake pedal.

T Threaded Stem Fitting with Hex Base Washer

PRB Wheel Plastic hub, grey color elastic rubber tire

Brake type	 mm	 mm		 mm	 mm	 mm	 mm	 kg	Code
TB/4 Total locking brake	150	32		1/2-13UNC	1"	50.0	189.5	100	Y680XT2/W624
	150	32		M10 P1.5	25.0	50.0	189.5	100	Y680XT3/W624
	150	32		M12 P1.75	25.0	50.0	189.5	100	Y680XT4/W624
	150	32		M16 P2.0	25.0	50.0	189.5	100	Y680XT5/W624
	150	32		5/8-11UNC	1-1/4"	50.0	189.5	100	Y680XT6/W624
	150	32		1/2-12UNC	1"	50.0	189.5	100	Y680XT7/W624
	150	32		1/2-20UNF	25.0	50.0	189.5	100	Y680XT10/W624
TB/3 Total locking brake	75	32		1/2-13UNC	1"	41.0	107.0	50	Y380T2/W324
	75	32		M10 P1.5	25.0	41.0	107.0	50	Y380T3/W324
	75	32		M12 P1.75	25.0	41.0	107.0	50	Y380T4/W324
	75	32		M16 P2.0	25.0	41.0	107.0	50	Y380T5/W324
	75	32		5/8-11UNC	1-1/4"	41.0	107.0	50	Y380T6/W324
	75	32		1/2-12UNC	1"	41.0	107.0	50	Y380T7/W324
	75	32		1/2-20UNF	25.0	41.0	107.0	50	Y380T10/W324
	100	32		1/2-13UNC	1"	40.5	135.0	80	Y480T2/W424
	100	32		M10 P1.5	25.0	40.5	135.0	80	Y480T3/W424
	100	32		M12 P1.75	25.0	40.5	135.0	80	Y480T4/W424
	100	32		M16 P2.0	25.0	40.5	135.0	80	Y480T5/W424
	100	32		5/8-11UNC	1-1/4"	40.5	135.0	80	Y480T6/W424
	100	32		1/2-12UNC	1"	40.5	135.0	80	Y480T7/W424
	100	32		1/2-20UNF	25.0	40.5	135.0	80	Y480T10/W424



Pressed steel, double ballrace swivel yoke, zinc-chromatized finish

Option: Bright chrome plated finish is also available, add suffix "-CR" to Catis code, e.g. Y580XP1/W503U-CR



TB Total locking brake

Total Lock system locks both swivel head and wheel simultaneously for secure parking. Integrated ON/OFF Nylon brake pedals for easy and quiet operation.



DB Directional locking brake

Directional Lock permits free wheel rotation while swivel head remains locked, an easy way to keep equipment traveling straight. Integrated ON/OFF Nylon brake pedals for easy and quiet operation. Release pedal in green color.

T Threaded Stem Fitting with Hex Base Washer



PRB Wheel Plastic hub, grey color elastic rubber tire

Brake type	mm	mm		mm	mm	mm	mm	kg	Code
TB Total locking brake	125	32		1/2-13UNC	1"	39.0	161.0	100	Y580T2/W524
	125	32		M10 P1.5	25.0	39.0	161.0	100	Y580T3/W524
	125	32		M12 P1.75	25.0	39.0	161.0	100	Y580T4/W524
	125	32		M16 P2.0	25.0	39.0	161.0	100	Y580T5/W524
	125	32		5/8-11UNC	1-1/4"	39.0	161.0	100	Y580T6/W524
	125	32		1/2-12UNC	1"	39.0	161.0	100	Y580T7/W524
	125	32		1/2-20UNF	25.0	39.0	161.0	100	Y580T10/W524
	150	32		1/2-13UNC	1"	46.5	189.5	100	Y680T2/W624
	150	32		M10 P1.5	25.0	46.5	189.5	100	Y680T3/W624
	150	32		M12 P1.75	25.0	46.5	189.5	100	Y680T4/W624
	150	32		M16 P2.0	25.0	46.5	189.5	100	Y680T5/W624
	150	32		5/8-11UNC	1-1/4"	46.5	189.5	100	Y680T6/W624
	150	32		1/2-12UNC	1"	46.5	189.5	100	Y680T7/W624
	150	32		1/2-20UNF	25.0	46.5	189.5	100	Y680T10/W624
Non-brake Free swivel	75	32		1/2-13UNC	1"	33.0	107.0	50	Y381T2/W324
	75	32		M10 P1.5	25.0	33.0	107.0	50	Y381T3/W324
	75	32		M12 P1.75	25.0	33.0	107.0	50	Y381T4/W324
	75	32		M16 P2.0	25.0	33.0	107.0	50	Y381T5/W324
	75	32		5/8-11UNC	1-1/4"	33.0	107.0	50	Y381T6/W324
	75	32		1/2-12UNC	1"	33.0	107.0	50	Y381T7/W324
	75	32		1/2-20UNF	25.0	33.0	107.0	50	Y381T10/W324





TB Total locking brake
 Total Lock system simultaneously locks both swivel head and wheel for a secure parking.
 Zinc-alloy brake pedal.

T Threaded Stem Fitting with Hex Base Washer

PRB Wheel Plastic hub, grey color elastic rubber tire

Brake type	mm	mm		mm	mm	mm	mm	kg	Code
Non-brake Free swivel	100	32		1/2-13UNC	1"	40.5	135.0	80	Y481T2/W424
	100	32		M10 P1.5	25.0	40.5	135.0	80	Y481T3/W424
	100	32		M12 P1.75	25.0	40.5	135.0	80	Y481T4/W424
	100	32		M16 P2.0	25.0	40.5	135.0	80	Y481T5/W424
	100	32		5/8-11UNC	1-1/4"	40.5	135.0	80	Y481T6/W424
	100	32		1/2-12UNC	1"	40.5	135.0	80	Y481T7/W424
	100	32		1/2-20UNF	25.0	40.5	135.0	80	Y481T10/W424
	125	32		1/2-13UNC	1"	39.0	161.0	100	Y581T2/W524
	125	32		M10 P1.5	25.0	39.0	161.0	100	Y581T3/W524
	125	32		M12 P1.75	25.0	39.0	161.0	100	Y581T4/W524
	125	32		M16 P2.0	25.0	39.0	161.0	100	Y581T5/W524
	125	32		5/8-11UNC	1-1/4"	39.0	161.0	100	Y581T6/W524
	125	32		1/2-12UNC	1"	39.0	161.0	100	Y581T7/W524
	125	32		1/2-20UNF	25.0	39.0	161.0	100	Y581T10/W524
150	32		1/2-13UNC	1"	50.0	189.5	100	Y681T2/W624	
	32		M10 P1.5	25.0	50.0	189.5	100	Y681T3/W624	
	32		M12 P1.75	25.0	50.0	189.5	100	Y681T4/W624	
	32		M16 P2.0	25.0	50.0	189.5	100	Y681T5/W624	
	32		5/8-11UNC	1-1/4"	50.0	189.5	100	Y681T6/W624	
	32		1/2-12UNC	1"	50.0	189.5	100	Y681T7/W624	
	32		1/2-20UNF	25.0	50.0	189.5	100	Y681T10/W624	



Pressed steel, double ballrace swivel yoke, zinc-chromatized finish

Option: Bright chrome plated finish is also available, add suffix "-CR" to Catis code, e.g. Y580XP1/W503U-CR



TB Total locking brake

Total Lock system locks both swivel head and wheel simultaneously for secure parking. Integrated ON/OFF Nylon brake pedals for easy and quiet operation.





DB Directional locking brake

Directional Lock permits free wheel rotation while swivel head remains locked, an easy way to keep equipment traveling straight. Integrated ON/OFF Nylon brake pedals for easy and quiet operation. Release pedal in green color.

T Threaded Stem Fitting with Hex Base Washer

SRB Wheel Pressed steel hub, grey color elastic rubber tire

Brake type	 mm	 mm		 mm	 mm	 mm	 mm	 kg	Code
TB Total locking brake	100	32		1/2-13UNC	1"	40.5	135.0	80	Y480XT2/W423
	100	32		M10 P1.5	25.0	40.5	135.0	80	Y480XT3/W423
	100	32		M12 P1.75	25.0	40.5	135.0	80	Y480XT4/W423
	100	32		M16 P2.0	25.0	40.5	135.0	80	Y480XT5/W423
	100	32		5/8-11UNC	1-1/4"	40.5	135.0	80	Y480XT6/W423
	100	32		1/2-12UNC	1"	40.5	135.0	80	Y480XT7/W423
	100	32		1/2-20UNF	25.0	40.5	135.0	80	Y480XT10/W423
	125	32		1/2-13UNC	1"	39.0	161.0	100	Y580XT2/W523
	125	32		M10 P1.5	25.0	39.0	161.0	100	Y580XT3/W523
	125	32		M12 P1.75	25.0	39.0	161.0	100	Y580XT4/W523
	125	32		M16 P2.0	25.0	39.0	161.0	100	Y580XT5/W523
	125	32		5/8-11UNC	1-1/4"	39.0	161.0	100	Y580XT6/W523
	125	32		1/2-12UNC	1"	39.0	161.0	100	Y580XT7/W523
	125	32		1/2-20UNF	25.0	39.0	161.0	100	Y580XT10/W523
	150	32		1/2-13UNC	1"	50.0	189.5	100	Y680XT2/W623
	150	32		M10 P1.5	25.0	50.0	189.5	100	Y680XT3/W623
150	32		M12 P1.75	25.0	50.0	189.5	100	Y680XT4/W623	
150	32		M16 P2.0	25.0	50.0	189.5	100	Y680XT5/W623	
150	32		5/8-11UNC	1-1/4"	50.0	189.5	100	Y680XT6/W623	
150	32		1/2-12UNC	1"	50.0	189.5	100	Y680XT7/W623	
150	32		1/2-20UNF	25.0	50.0	189.5	100	Y680XT10/W623	

































TB Total locking brake
 Total Lock system simultaneously locks both swivel head and wheel for a secure parking.
 Zinc-alloy brake pedal.

T Threaded Stem Fitting with Hex Base Washer

SRB Wheel Pressed steel hub, grey color elastic rubber tire

Brake type	 mm	 mm		 mm	 mm	 mm	 kg	Code	
TB Total locking brake	100	32		1/2-13UNC	1"	40.5	135.0	80	Y480T2/W423
	100	32		M10 P1.5	25.0	40.5	135.0	80	Y480T3/W423
	100	32		M12 P1.75	25.0	40.5	135.0	80	Y480T4/W423
	100	32		M16 P2.0	25.0	40.5	135.0	80	Y480T5/W423
	100	32		5/8-11UNC	1-1/4"	40.5	135.0	80	Y480T6/W423
	100	32		1/2-12UNC	1"	40.5	135.0	80	Y480T7/W423
	100	32		1/2-20UNF	25.0	40.5	135.0	80	Y480T10/W423
	125	32		1/2-13UNC	1"	39.0	161.0	100	Y580T2/W523
	125	32		M10 P1.5	25.0	39.0	161.0	100	Y580T3/W523
	125	32		M12 P1.75	25.0	39.0	161.0	100	Y580T4/W523
	125	32		M16 P2.0	25.0	39.0	161.0	100	Y580T5/W523
	125	32		5/8-11UNC	1-1/4"	39.0	161.0	100	Y580T6/W523
	125	32		1/2-12UNC	1"	39.0	161.0	100	Y580T7/W523
	125	32		1/2-20UNF	25.0	39.0	161.0	100	Y580T10/W523
	150	32		1/2-13UNC	1"	46.5	189.5	100	Y680T2/W623
	150	32		M10 P1.5	25.0	46.5	189.5	100	Y680T3/W623
	150	32		M12 P1.75	25.0	46.5	189.5	100	Y680T4/W623
	150	32		M16 P2.0	25.0	46.5	189.5	100	Y680T5/W623
150	32		5/8-11UNC	1-1/4"	46.5	189.5	100	Y680T6/W623	
150	32		1/2-12UNC	1"	46.5	189.5	100	Y680T7/W623	
150	32		1/2-20UNF	25.0	46.5	189.5	100	Y680T10/W623	



Pressed steel, double ballrace swivel yoke, zinc-chromatized finish

Option: Bright chrome plated finish is also available, add suffix "-CR" to Catis code, e.g. Y580XP1/W503U-CR



TB/A Total locking brake

Total Lock system locks both swivel head and wheel simultaneously for secure parking. Integrated ON/OFF Nylon brake pedals for easy and quiet operation.



DB/A Directional locking brake























Directional Lock permits free wheel rotation while swivel head remains locked, an easy way to keep equipment traveling straight. Integrated ON/OFF Nylon brake pedals for easy and quiet operation. Release pedal in green color.

T Threaded Stem Fitting with Hex Base Washer



SRB Wheel

Pressed steel hub, grey color elastic rubber tire

Brake type	 mm	 mm		 mm	 mm	 mm	 mm	 kg	Code
Non-brake Free swivel	100	32		1/2-13UNC	1"	40.5	135.0	80	Y481T2/W423
	100	32		M10 P1.5	25.0	40.5	135.0	80	Y481T3/W423
	100	32		M12 P1.75	25.0	40.5	135.0	80	Y481T4/W423
	100	32		M16 P2.0	25.0	40.5	135.0	80	Y481T5/W423
	100	32		5/8-11UNC	1-1/4"	40.5	135.0	80	Y481T6/W423
	100	32		1/2-12UNC	1"	40.5	135.0	80	Y481T7/W423
	100	32		1/2-20UNF	25.0	40.5	135.0	80	Y481T10/W423
	125	32		1/2-13UNC	1"	39.0	161.0	100	Y581T2/W523
	125	32		M10 P1.5	25.0	39.0	161.0	100	Y581T3/W523
	125	32		M12 P1.75	25.0	39.0	161.0	100	Y581T4/W523
	125	32		M16 P2.0	25.0	39.0	161.0	100	Y581T5/W523
	125	32		5/8-11UNC	1-1/4"	39.0	161.0	100	Y581T6/W523
	125	32		1/2-12UNC	1"	39.0	161.0	100	Y581T7/W523
	125	32		1/2-20UNF	25.0	39.0	161.0	100	Y581T10/W523





TB Total locking brake
 Total Lock system simultaneously locks both swivel head and wheel for a secure parking.
 Zinc-alloy brake pedal.

T Threaded Stem Fitting with Hex Base Washer

SRB Wheel Pressed steel hub, grey color elastic rubber tire

Brake type	mm	mm		mm	mm	mm	mm	kg	Code
Non-brake Free swivel	150	32		1/2-13UNC	1"	50.0	189.5	100	Y681T2/W623
	150	32		M10 P1.5	25.0	50.0	189.5	100	Y681T3/W623
	150	32		M12 P1.75	25.0	50.0	189.5	100	Y681T4/W623
	150	32		M16 P2.0	25.0	50.0	189.5	100	Y681T5/W623
	150	32		5/8-11UNC	1-1/4"	50.0	189.5	100	Y681T6/W623
	150	32		1/2-12UNC	1"	50.0	189.5	100	Y681T7/W623
	150	32		1/2-20UNF	25.0	50.0	189.5	100	Y681T10/W623



SRB/BKAS Wheel Conductive wheels are also available

		Code
Pressed steel hub and threadguards, zinc-chromatized finish, black color conductive rubber tire Add suffix "-CR" to Catis code for bright chrome finish	100 x 32mm	W423-BKAS
	125 x 32mm	W523-BKAS
	150 x 32mm	W623-BKAS



Electrical Resistance $\leq 10^4 \Omega$

Pressed steel, double ballrace swivel yoke, zinc-chromatized finish

Option: Bright chrome plated finish is also available, add suffix "-CR" to Catis code, e.g. Y580XP1/W503U-CR



TB Total locking brake

Total Lock system locks both swivel head and wheel simultaneously for secure parking. Integrated ON/OFF Nylon brake pedals for easy and quiet operation.



DB Directional locking brake

Directional Lock permits free wheel rotation while swivel head remains locked, an easy way to keep equipment traveling straight. Integrated ON/OFF Nylon brake pedals for easy and quiet operation. Release pedal in green color.

T Threaded Stem Fitting with Hex Base Washer



TPR Wheel

Plastic hub, grey color thermoplastic rubber tire

Brake type	mm	mm		mm	mm	mm	mm	kg	Code
TB Total locking brake	75	25		1/2-13UNC	1"	30.0	107.0	45	Y360T2/W312
	75	25		M10 P1.5	25.0	30.0	107.0	45	Y360T3/W312
	75	25		M12 P1.75	25.0	30.0	107.0	45	Y360T4/W312
	75	25		M16 P2.0	25.0	30.0	107.0	45	Y360T5/W312
	75	25		5/8-11UNC	1-1/4"	30.0	107.0	45	Y360T6/W312
	75	25		1/2-12UNC	1"	30.0	107.0	45	Y360T7/W312
	75	25		1/2-20UNF	25.0	30.0	107.0	45	Y360T10/W312
	100	25		1/2-13UNC	1"	38.5	135.0	60	Y460T2/W412
	100	25		M10 P1.5	25.0	38.5	135.0	60	Y460T3/W412
	100	25		M12 P1.75	25.0	38.5	135.0	60	Y460T4/W412
	100	25		M16 P2.0	25.0	38.5	135.0	60	Y460T5/W412
	100	25		5/8-11UNC	1-1/4"	38.5	135.0	60	Y460T6/W412
	100	25		1/2-12UNC	1"	38.5	135.0	60	Y460T7/W412
	100	25		1/2-20UNF	25.0	38.5	135.0	60	Y460T10/W412

























TB Total locking brake
 Total Lock system simultaneously locks both swivel head and wheel for a secure parking.
 Zinc-alloy brake pedal.

T Threaded Stem Fitting with Hex Base Washer

TPR Wheel Plastic hub, grey color thermoplastic rubber tire

Brake type	 mm	 mm		 mm	 mm	 mm	 kg	Code	
TB Total locking brake	125	25		1/2-13UNC	1"	38.5	161.0	70	Y560T2/W512
	125	25		M10 P1.5	25.0	38.5	161.0	70	Y560T3/W512
	125	25		M12 P1.75	25.0	38.5	161.0	70	Y560T4/W512
	125	25		M16 P2.0	25.0	38.5	161.0	70	Y560T5/W512
	125	25		5/8-11UNC	1-1/4"	38.5	161.0	70	Y560T6/W512
	125	25		1/2-12UNC	1"	38.5	161.0	70	Y560T7/W512
	125	25		1/2-20UNF	25.0	38.5	161.0	70	Y560T10/W512
	100	32		1/2-13UNC	1"	40.5	135.0	80	Y480XT2/W403
	100	32		M10 P1.5	25.0	40.5	135.0	80	Y480XT3/W403
	100	32		M12 P1.75	25.0	40.5	135.0	80	Y480XT4/W403
100	32		M16 P2.0	25.0	40.5	135.0	80	Y480XT5/W403	
100	32		5/8-11UNC	1-1/4"	40.5	135.0	80	Y480XT6/W403	
100	32		1/2-12UNC	1"	40.5	135.0	80	Y480XT7/W403	
100	32		1/2-20UNF	25.0	40.5	135.0	80	Y480XT10/W403	



Pressed steel, double ballrace swivel yoke, zinc-chromatized finish

Option: Bright chrome plated finish is also available, add suffix "-CR" to Catis code, e.g. Y580XP1/W503U-CR



TB Total locking brake
Total Lock system locks both swivel head and wheel simultaneously for secure parking. Integrated ON/OFF Nylon brake pedals for easy and quiet operation.



DB Directional locking brake
Directional Lock permits free wheel rotation while swivel head remains locked, an easy way to keep equipment traveling straight. Integrated ON/OFF Nylon brake pedals for easy and quiet operation. Release pedal in green color.

T Threaded Stem Fitting with Hex Base Washer

TPR Wheel Plastic hub, grey color thermoplastic rubber tire

Brake type	mm	mm		mm	mm	mm	mm	kg	Code
TB Total locking brake	125	32		1/2-13UNC	1"	39.0	161.0	100	Y580XT2/W503
	125	32		M10 P1.5	25.0	39.0	161.0	100	Y580XT3/W503
	125	32		M12 P1.75	25.0	39.0	161.0	100	Y580XT4/W503
	125	32		M16 P2.0	25.0	39.0	161.0	100	Y580XT5/W503
	125	32		5/8-11UNC	1-1/4"	39.0	161.0	100	Y580XT6/W503
	125	32		1/2-12UNC	1"	39.0	161.0	100	Y580XT7/W503
	125	32		1/2-20UNF	25.0	39.0	161.0	100	Y580XT10/W503
	125	32		1/2-13UNC	1"	39.0	161.0	100	Y580XT2/W503U
	125	32		M10 P1.5	25.0	39.0	161.0	100	Y580XT3/W503U
	125	32		M12 P1.75	25.0	39.0	161.0	100	Y580XT4/W503U
	125	32		M16 P2.0	25.0	39.0	161.0	100	Y580XT5/W503U
	125	32		5/8-11UNC	1-1/4"	39.0	161.0	100	Y580XT6/W503U
	125	32		1/2-12UNC	1"	39.0	161.0	100	Y580XT7/W503U
	125	32		1/2-20UNF	25.0	39.0	161.0	100	Y580XT10/W503U
	150	32		1/2-13UNC	1"	50.0	189.5	100	Y680XT2/W603U
	150	32		M10 P1.5	25.0	50.0	189.5	100	Y680XT3/W603U
	150	32		M12 P1.75	25.0	50.0	189.5	100	Y680XT4/W603U
	150	32		M16 P2.0	25.0	50.0	189.5	100	Y680XT5/W603U
	150	32		5/8-11UNC	1-1/4"	50.0	189.5	100	Y680XT6/W603U
	150	32		1/2-12UNC	1"	50.0	189.5	100	Y680XT7/W603U
150	32		1/2-20UNF	25.0	50.0	189.5	100	Y680XT10/W603U	



























TB/B Total locking brake
 Total Lock system simultaneously locks both swivel head and wheel for a secure parking.
 Zinc-alloy brake pedal.

T Threaded Stem Fitting with Hex Base Washer

TPR Wheel Plastic hub, grey color thermoplastic rubber tire

Brake type	 mm	 mm		 mm	 mm	 mm	 mm	 kg	Code
TB/B Total locking brake	100	32		1/2-13UNC	1"	40.5	135.0	80	Y480T2/W403
	100	32		M10 P1.5	25.0	40.5	135.0	80	Y480T3/W403
	100	32		M12 P1.75	25.0	40.5	135.0	80	Y480T4/W403
	100	32		M16 P2.0	25.0	40.5	135.0	80	Y480T5/W403
	100	32		5/8-11UNC	1-1/4"	40.5	135.0	80	Y480T6/W403
	100	32		1/2-12UNC	1"	40.5	135.0	80	Y480T7/W403
	100	32		1/2-20UNF	25.0	40.5	135.0	80	Y480T10/W403
	125	32		1/2-13UNC	1"	39.0	161.0	100	Y580T2/W503
	125	32		M10 P1.5	25.0	39.0	161.0	100	Y580T3/W503
	125	32		M12 P1.75	25.0	39.0	161.0	100	Y580T4/W503
	125	32		M16 P2.0	25.0	39.0	161.0	100	Y580T5/W503
	125	32		5/8-11UNC	1-1/4"	39.0	161.0	100	Y580T6/W503
	125	32		1/2-12UNC	1"	39.0	161.0	100	Y580T7/W503
	125	32		1/2-20UNF	25.0	39.0	161.0	100	Y580T10/W503



Pressed steel, double ballrace swivel yoke, zinc-chromatized finish

Option: Bright chrome plated finish is also available, add suffix "-CR" to Catis code, e.g. Y580XP1/W503U-CR



TB/A Total locking brake

Total Lock system locks both swivel head and wheel simultaneously for secure parking. Integrated ON/OFF Nylon brake pedals for easy and quiet operation.



DB/A Directional locking brake























Directional Lock permits free wheel rotation while swivel head remains locked, an easy way to keep equipment traveling straight. Integrated ON/OFF Nylon brake pedals for easy and quiet operation. Release pedal in green color.

T Threaded Stem Fitting with Hex Base Washer



TPR Wheel

Plastic hub, grey color thermoplastic rubber tire

Brake type	 mm	 mm		 mm	 mm	 mm	 mm	 kg	Code
TB/B Total locking brake	125	32		1/2-13UNC	1"	39.0	161.0	100	Y580T2/W503U
	125	32		M10 P1.5	25.0	39.0	161.0	100	Y580T3/W503U
	125	32		M12 P1.75	25.0	39.0	161.0	100	Y580T4/W503U
	125	32		M16 P2.0	25.0	39.0	161.0	100	Y580T5/W503U
	125	32		5/8-11UNC	1-1/4"	39.0	161.0	100	Y580T6/W503U
	125	32		1/2-12UNC	1"	39.0	161.0	100	Y580T7/W503U
	125	32		1/2-20UNF	25.0	39.0	161.0	100	Y580T10/W503U
	150	32		1/2-13UNC	1"	46.5	189.5	100	Y680T2/W603U
	150	32		M10 P1.5	25.0	46.5	189.5	100	Y680T3/W603U
	150	32		M12 P1.75	25.0	46.5	189.5	100	Y680T4/W603U
	150	32		M16 P2.0	25.0	46.5	189.5	100	Y680T5/W603U
	150	32		5/8-11UNC	1-1/4"	46.5	189.5	100	Y680T6/W603U
	150	32		1/2-12UNC	1"	46.5	189.5	100	Y680T7/W603U
	150	32		1/2-20UNF	25.0	46.5	189.5	100	Y680T10/W603U



























TB Total locking brake
 Total Lock system simultaneously locks both swivel head and wheel for a secure parking.
 Zinc-alloy brake pedal.

T Threaded Stem Fitting with Hex Base Washer

TPR Wheel Plastic hub, grey color thermoplastic rubber tire

Brake type	 mm	 mm		 mm	 mm	 mm	 mm	 kg	Code
Non-brake Free swivel	75	25		1/2-13UNC	1"	30.0	107.0	45	Y361T2/W312
	75	25		M10 P1.5	25.0	30.0	107.0	45	Y361T3/W312
	75	25		M12 P1.75	25.0	30.0	107.0	45	Y361T4/W312
	75	25		M16 P2.0	25.0	30.0	107.0	45	Y361T5/W312
	75	25		5/8-11UNC	1-1/4"	30.0	107.0	45	Y361T6/W312
	75	25		1/2-12UNC	1"	30.0	107.0	45	Y361T7/W312
	75	25		1/2-20UNF	25.0	30.0	107.0	45	Y361T10/W312
	100	25		1/2-13UNC	1"	38.5	135.0	60	Y461T2/W412
	100	25		M10 P1.5	25.0	38.5	135.0	60	Y461T3/W412
	100	25		M12 P1.75	25.0	38.5	135.0	60	Y461T4/W412
100	25		M16 P2.0	25.0	38.5	135.0	60	Y461T5/W412	
100	25		5/8-11UNC	1-1/4"	38.5	135.0	60	Y461T6/W412	
100	25		1/2-12UNC	1"	38.5	135.0	60	Y461T7/W412	
100	25		1/2-20UNF	25.0	38.5	135.0	60	Y461T10/W412	



Pressed steel, double ballrace swivel yoke, zinc-chromatized finish

Option: Bright chrome plated finish is also available, add suffix "-CR" to Catis code, e.g. Y580XP1/W503U-CR



TB/A Total locking brake

Total Lock system locks both swivel head and wheel simultaneously for secure parking. Integrated ON/OFF Nylon brake pedals for easy and quiet operation.



DB/A Directional locking brake























Directional Lock permits free wheel rotation while swivel head remains locked, an easy way to keep equipment traveling straight. Integrated ON/OFF Nylon brake pedals for easy and quiet operation. Release pedal in green color.

T Threaded Stem Fitting with Hex Base Washer



TPR Wheel

Plastic hub, grey color thermoplastic rubber tire

Brake type	 mm	 mm		 mm	 mm	 mm	 mm	 kg	Code
Non-brake Free swivel	125	25		1/2-13UNC	1"	38.5	161.0	70	Y561T2/W512
	125	25		M10 P1.5	25.0	38.5	161.0	70	Y561T3/W512
	125	25		M12 P1.75	25.0	38.5	161.0	70	Y561T4/W512
	125	25		M16 P2.0	25.0	38.5	161.0	70	Y561T5/W512
	125	25		5/8-11UNC	1-1/4"	38.5	161.0	70	Y561T6/W512
	125	25		1/2-12UNC	1"	38.5	161.0	70	Y561T7/W512
	125	25		1/2-20UNF	25.0	38.5	161.0	70	Y561T10/W512
	100	32		1/2-13UNC	1"	40.5	135.0	80	Y481T2/W403
	100	32		M10 P1.5	25.0	40.5	135.0	80	Y481T3/W403
	100	32		M12 P1.75	25.0	40.5	135.0	80	Y481T4/W403
100	32		M16 P2.0	25.0	40.5	135.0	80	Y481T5/W403	
100	32		5/8-11UNC	1-1/4"	40.5	135.0	80	Y481T6/W403	
100	32		1/2-12UNC	1"	40.5	135.0	80	Y481T7/W403	
100	32		1/2-20UNF	25.0	40.5	135.0	80	Y481T10/W403	



























TB Total locking brake
 Total Lock system simultaneously locks both swivel head and wheel for a secure parking.
 Zinc-alloy brake pedal.

T Threaded Stem Fitting with Hex Base Washer

TPR Wheel Plastic hub, grey color thermoplastic rubber tire

Brake type	 mm	 mm		 mm	 mm	 mm	 mm	 kg	Code
Non-brake Free swivel	125	32		1/2-13UNC	1"	39.0	161.0	100	Y581T2/W503
	125	32		M10 P1.5	25.0	39.0	161.0	100	Y581T3/W503
	125	32		M12 P1.75	25.0	39.0	161.0	100	Y581T4/W503
	125	32		M16 P2.0	25.0	39.0	161.0	100	Y581T5/W503
	125	32		5/8-11UNC	1-1/4"	39.0	161.0	100	Y581T6/W503
	125	32		1/2-12UNC	1"	39.0	161.0	100	Y581T7/W503
	125	32		1/2-20UNF	25.0	39.0	161.0	100	Y581T10/W503
	125	32		1/2-13UNC	1"	39.0	161.0	100	Y581T2/W503U
	125	32		M10 P1.5	25.0	39.0	161.0	100	Y581T3/W503U
	125	32		M12 P1.75	25.0	39.0	161.0	100	Y581T4/W503U
	125	32		M16 P2.0	25.0	39.0	161.0	100	Y581T5/W503U
	125	32		5/8-11UNC	1-1/4"	39.0	161.0	100	Y581T6/W503U
	125	32		1/2-12UNC	1"	39.0	161.0	100	Y581T7/W503U
	125	32		1/2-20UNF	25.0	39.0	161.0	100	Y581T10/W503U



Pressed steel, double ballrace swivel yoke, zinc-chromatized finish

Option: Bright chrome plated finish is also available, add suffix "-CR" to Catis code, e.g. Y580XP1/W503U-CR



TB/A Total locking brake

Total Lock system locks both swivel head and wheel simultaneously for secure parking. Integrated ON/OFF Nylon brake pedals for easy and quiet operation.



DB/A Directional locking brake







Directional Lock permits free wheel rotation while swivel head remains locked, an easy way to keep equipment traveling straight. Integrated ON/OFF Nylon brake pedals for easy and quiet operation. Release pedal in green color.

T Threaded Stem Fitting with Hex Base Washer



TPR Wheel

Plastic hub, grey color thermoplastic rubber tire

Brake type	 mm	 mm		 mm	 mm	 mm	 mm	 kg	Code
Non-brake Free swivel	150	32		1/2-13UNC	1"	50.0	189.5	100	Y681T2/W603U
	150	32		M10 P1.5	25.0	50.0	189.5	100	Y681T3/W603U
	150	32		M12 P1.75	25.0	50.0	189.5	100	Y681T4/W603U
	150	32		M16 P2.0	25.0	50.0	189.5	100	Y681T5/W603U
	150	32		5/8-11UNC	1-1/4"	50.0	189.5	100	Y681T6/W603U
	150	32		1/2-12UNC	1"	50.0	189.5	100	Y681T7/W603U
	150	32		1/2-20UNF	25.0	50.0	189.5	100	Y681T10/W603U



TPR/AS Wheel

Conductive wheels are also available

		Code
Plastic hub and threadguards, grey color conductive thermoplastic rubber tire	075 x 25mm	W303CX-AS*
	100 x 32mm	W403-AS
	125 x 32mm	W503-AS
	150 x 32mm	W603U-AS



*Wheel with metal threadguards (see P020)

Electrical Resistance $\leq 10^4 \Omega$



TB Total locking brake
 Total Lock system simultaneously locks both swivel head and wheel for a secure parking.
 Zinc-alloy brake pedal.

T Threaded Stem Fitting with Hex Base Washer

TPU Wheel Plastic hub, grey color polyurethane tire

Brake type	mm	mm		mm	mm	mm	mm	kg	Code
TB Total locking brake	75	32		1/2-13UNC	1"	33.0	107.0	50	Y380XT2/W300
	75	32		M10 P1.5	25.0	33.0	107.0	50	Y380XT3/W300
	75	32		M12 P1.75	25.0	33.0	107.0	50	Y380XT4/W300
	75	32		M16 P2.0	25.0	33.0	107.0	50	Y380XT5/W300
	75	32		5/8-11UNC	1-1/4"	33.0	107.0	50	Y380XT6/W300
	75	32		1/2-12UNC	1"	33.0	107.0	50	Y380XT7/W300
	75	32		1/2-20UNF	25.0	33.0	107.0	50	Y380XT10/W300



Pressed steel, double ballrace swivel yoke, zinc-chromatized finish

Option: Bright chrome plated finish is also available, add suffix "-CR" to Catis code, e.g. Y580XP1/W503U-CR



TB Total locking brake

Total Lock system locks both swivel head and wheel simultaneously for secure parking. Integrated ON/OFF Nylon brake pedals for easy and quiet operation.



DB Directional locking brake

Directional Lock permits free wheel rotation while swivel head remains locked, an easy way to keep equipment traveling straight. Integrated ON/OFF Nylon brake pedals for easy and quiet operation. Release pedal in green color.

T Threaded Stem Fitting with Hex Base Washer



TPU Wheel Plastic hub, grey color polyurethane tire

Brake type	mm	mm		mm	mm	mm	mm	kg	Code
TB Total locking brake	100	32		1/2-13UNC	1"	40.5	135.0	80	Y480XT2/W400E
	100	32		M10 P1.5	25.0	40.5	135.0	80	Y480XT3/W400E
	100	32		M12 P1.75	25.0	40.5	135.0	80	Y480XT4/W400E
	100	32		M16 P2.0	25.0	40.5	135.0	80	Y480XT5/W400E
	100	32		5/8-11UNC	1-1/4"	40.5	135.0	80	Y480XT6/W400E
	100	32		1/2-12UNC	1"	40.5	135.0	80	Y480XT7/W400E
	100	32		1/2-20UNF	25.0	40.5	135.0	80	Y480XT10/W400E
	125	32		1/2-13UNC	1"	39.0	161.0	100	Y580XT2/W500E
	125	32		M10 P1.5	25.0	39.0	161.0	100	Y580XT3/W500E
	125	32		M12 P1.75	25.0	39.0	161.0	100	Y580XT4/W500E
	125	32		M16 P2.0	25.0	39.0	161.0	100	Y580XT5/W500E
	125	32		5/8-11UNC	1-1/4"	39.0	161.0	100	Y580XT6/W500E
	125	32		1/2-12UNC	1"	39.0	161.0	100	Y580XT7/W500E
	125	32		1/2-20UNF	25.0	39.0	161.0	100	Y580XT10/W500E
	150	32		1/2-13UNC	1"	50.0	189.5	100	Y680XT2/W600E
	150	32		M10 P1.5	25.0	50.0	189.5	100	Y680XT3/W600E
150	32		M12 P1.75	25.0	50.0	189.5	100	Y680XT4/W600E	
150	32		M16 P2.0	25.0	50.0	189.5	100	Y680XT5/W600E	
150	32		5/8-11UNC	1-1/4"	50.0	189.5	100	Y680XT6/W600E	
150	32		1/2-12UNC	1"	50.0	189.5	100	Y680XT7/W600E	
150	32		1/2-20UNF	25.0	50.0	189.5	100	Y680XT10/W600E	





TLB Total locking brake
 Total Lock system simultaneously locks both swivel head and wheel for a secure parking.
 Zinc-alloy brake pedal.

T Threaded Stem Fitting with Hex Base Washer

TPU Wheel Plastic hub, grey color polyurethane tire

Brake type	mm	mm		mm	mm	mm	mm	kg	Code
TLB Total locking brake	75	32		1/2-13UNC	1_	41.0	107.0	50	Y380T2/W300
	75	32		M10 P1.5	25.0	41.0	107.0	50	Y380T3/W300
	75	32		M12 P1.75	25.0	41.0	107.0	50	Y380T4/W300
	75	32		M16 P2.0	25.0	41.0	107.0	50	Y380T5/W300
	75	32		5/8-11UNC	1-1/4_	41.0	107.0	50	Y380T6/W300
	75	32		1/2-12UNC	1_	41.0	107.0	50	Y380T7/W300
	75	32		1/2-20UNF	25.0	41.0	107.0	50	Y380T10/W300



Pressed steel, double ballrace swivel yoke, zinc-chromatized finish

Option: Bright chrome plated finish is also available, add suffix "-CR" to Catis code, e.g. Y580XP1/W503U-CR



TB/A Total locking brake

Total Lock system locks both swivel head and wheel simultaneously for secure parking. Integrated ON/OFF Nylon brake pedals for easy and quiet operation.



DB/A Directional locking brake

Directional Lock permits free wheel rotation while swivel head remains locked, an easy way to keep equipment traveling straight. Integrated ON/OFF Nylon brake pedals for easy and quiet operation. Release pedal in green color.

T Threaded Stem Fitting with Hex Base Washer



TPU Wheel Plastic hub, grey color polyurethane tire

Brake type	mm	mm		mm	mm	mm	mm	kg	Code
TB/B Total locking brake	100	32		1/2-13UNC	1_	40.5	135.0	80	Y480T2/W400E
	100	32		M10 P1.5	25.0	40.5	135.0	80	Y480T3/W400E
	100	32		M12 P1.75	25.0	40.5	135.0	80	Y480T4/W400E
	100	32		M16 P2.0	25.0	40.5	135.0	80	Y480T5/W400E
	100	32		5/8-11UNC	1-1/4_	40.5	135.0	80	Y480T6/W400E
	100	32		1/2-12UNC	1_	40.5	135.0	80	Y480T7/W400E
	100	32		1/2-20UNF	25.0	40.5	135.0	80	Y480T10/W400E
	125	32		1/2-13UNC	1_	39.0	161.0	100	Y580T2/W500E
	125	32		M10 P1.5	25.0	39.0	161.0	100	Y580T3/W500E
	125	32		M12 P1.75	25.0	39.0	161.0	100	Y580T4/W500E
	125	32		M16 P2.0	25.0	39.0	161.0	100	Y580T5/W500E
	125	32		5/8-11UNC	1-1/4_	39.0	161.0	100	Y580T6/W500E
	125	32		1/2-12UNC	1_	39.0	161.0	100	Y580T7/W500E
	125	32		1/2-20UNF	25.0	39.0	161.0	100	Y580T10/W500E
	150	32		1/2-13UNC	1_	46.5	189.5	100	Y680T2/W600E
	150	32		M10 P1.5	25.0	46.5	189.5	100	Y680T3/W600E
150	32		M12 P1.75	25.0	46.5	189.5	100	Y680T4/W600E	
150	32		M16 P2.0	25.0	46.5	189.5	100	Y680T5/W600E	
150	32		5/8-11UNC	1-1/4_	46.5	189.5	100	Y680T6/W600E	
150	32		1/2-12UNC	1_	46.5	189.5	100	Y680T7/W600E	
150	32		1/2-20UNF	25.0	46.5	189.5	100	Y680T10/W600E	



















TB Total locking brake
 Total Lock system simultaneously locks both swivel head and wheel for a secure parking.
 Zinc-alloy brake pedal.

T Threaded Stem Fitting with Hex Base Washer

TPU Wheel Plastic hub, grey color polyurethane tire

Brake type	 mm	 mm		 mm	 mm	 mm	 mm	 kg	Code
Non-brake Free swivel	75	32		1/2-13UNC	1"	33.0	107.0	50	Y381T2/W300
	75	32		M10 P1.5	25.0	33.0	107.0	50	Y381T3/W300
	75	32		M12 P1.75	25.0	33.0	107.0	50	Y381T4/W300
	75	32		M16 P2.0	25.0	33.0	107.0	50	Y381T5/W300
	75	32		5/8-11UNC	1-1/4"	33.0	107.0	50	Y381T6/W300
	75	32		1/2-12UNC	1"	33.0	107.0	50	Y381T7/W300
	75	32		1/2-20UNF	25.0	33.0	107.0	50	Y381T10/W300



Pressed steel, double ballrace swivel yoke, zinc-chromatized finish

Option: Bright chrome plated finish is also available, add suffix "-CR" to Catis code, e.g. Y580XP1/W503U-CR



TB/A Total locking brake

Total Lock system locks both swivel head and wheel simultaneously for secure parking. Integrated ON/OFF Nylon brake pedals for easy and quiet operation.











DB/A Directional locking brake

Directional Lock permits free wheel rotation while swivel head remains locked, an easy way to keep equipment traveling straight. Integrated ON/OFF Nylon brake pedals for easy and quiet operation. Release pedal in green color.

T Threaded Stem Fitting with Hex Base Washer

TPU Wheel Plastic hub, grey color thermoplastic rubber tire

Brake type	 mm	 mm		 mm	 mm	 mm	 mm	 kg	Code
Non-brake Free swivel	100	32		1/2-13UNC	1"	40.5	135.0	80	Y481T2/W400E
	100	32		M10 P1.5	25.0	40.5	135.0	80	Y481T3/W400E
	100	32		M12 P1.75	25.0	40.5	135.0	80	Y481T4/W400E
	100	32		M16 P2.0	25.0	40.5	135.0	80	Y481T5/W400E
	100	32		5/8-11UNC	1-1/4"	40.5	135.0	80	Y481T6/W400E
	100	32		1/2-12UNC	1"	40.5	135.0	80	Y481T7/W400E
	100	32		1/2-20UNF	25.0	40.5	135.0	80	Y481T10/W400E
	125	32		1/2-13UNC	1"	39.0	161.0	100	Y581T2/W500E
	125	32		M10 P1.5	25.0	39.0	161.0	100	Y581T3/W500E
	125	32		M12 P1.75	25.0	39.0	161.0	100	Y581T4/W500E
	125	32		M16 P2.0	25.0	39.0	161.0	100	Y581T5/W500E
	125	32		5/8-11UNC	1-1/4"	39.0	161.0	100	Y581T6/W500E
	125	32		1/2-12UNC	1"	39.0	161.0	100	Y581T7/W500E
	125	32		1/2-20UNF	25.0	39.0	161.0	100	Y581T10/W500E
	150	32		1/2-13UNC	1"	50.0	189.5	100	Y681T2/W600E
	150	32		M10 P1.5	25.0	50.0	189.5	100	Y681T3/W600E
150	32		M12 P1.75	25.0	50.0	189.5	100	Y681T4/W600E	
150	32		M16 P2.0	25.0	50.0	189.5	100	Y681T5/W600E	
150	32		5/8-11UNC	1-1/4"	50.0	189.5	100	Y681T6/W600E	
150	32		1/2-12UNC	1"	50.0	189.5	100	Y681T7/W600E	
150	32		1/2-20UNF	25.0	50.0	189.5	100	Y681T10/W600E	





TB Total locking brake
 Total Lock system simultaneously locks both swivel head and wheel for a secure parking.
 Zinc-alloy brake pedal.

T Threaded Stem Fitting with Hex Base Washer

ARB Wheel Al-alloy hub, grey color high elastic rubber tire

Brake type	mm	mm		mm	mm	mm	mm	kg	Code
TB Total locking brake	125	32		1/2-13UNC	1"	39.0	161.0	100	Y580XT2/W529UX
	125	32		M16 P2.0	25.0	39.0	161.0	100	Y580XT5/W529UX
	125	32		1/2-20UNF	25.0	39.0	161.0	100	Y580XT10/W529UX
	150	32		1/2-13UNC	1"	50.0	189.5	100	Y680XT2/W629UX
	150	32		M16 P2.0	25.0	50.0	189.5	100	Y680XT5/W629UX
	150	32		1/2-20UNF	25.0	50.0	189.5	100	Y680XT10/W629UX
TB Total locking brake	125	32		1/2-13UNC	1"	39.0	161.0	100	Y580T2/W529UX
	125	32		M16 P2.0	25.0	39.0	161.0	100	Y580T5/W529UX
	125	32		1/2-20UNF	25.0	39.0	161.0	100	Y580T10/W529UX
	150	32		1/2-13UNC	1"	46.5	189.5	100	Y680T2/W629UX
	150	32		M16 P2.0	25.0	46.5	189.5	100	Y680T5/W629UX
	150	32		1/2-20UNF	25.0	46.5	189.5	100	Y680T10/W629UX
Non-brake Free swivel	125	32		1/2-13UNC	1"	39.0	161.0	100	Y581T2/W529UX
	125	32		M16 P2.0	25.0	39.0	161.0	100	Y581T5/W529UX
	125	32		1/2-20UNF	25.0	39.0	161.0	100	Y581T10/W529UX
	150	32		1/2-13UNC	1"	50.0	189.5	100	Y681T2/W629UX
	150	32		M16 P2.0	25.0	50.0	189.5	100	Y681T5/W629UX
	150	32		1/2-20UNF	25.0	50.0	189.5	100	Y681T10/W629UX



Pressed steel, double ballrace swivel yoke, zinc-chromatized finish

Option: Bright chrome plated finish is also available, add suffix "-CR" to Catis code, e.g. Y580XP1/W503U-CR



TB Total locking brake

Total Lock system locks both swivel head and wheel simultaneously for secure parking. Integrated ON/OFF Nylon brake pedals for easy and quiet operation.



DB Directional locking brake

Directional Lock permits free wheel rotation while swivel head remains locked, an easy way to keep equipment traveling straight. Integrated ON/OFF Nylon brake pedals for easy and quiet operation. Release pedal in green color.

T Threaded Stem Fitting with Hex Base Washer



PM Wheel Solid nylon wheel

Brake type	mm	mm		mm	mm	mm	mm	kg	Code
TB Total locking brake	75	32		1/2-13UNC	1"	33.0	107.0	50	Y380XT2/W309RX
	75	32		M10 P1.5	25.0	33.0	107.0	50	Y380XT3/W309RX
	75	32		M12 P1.75	25.0	33.0	107.0	50	Y380XT4/W309RX
	75	32		M16 P2.0	25.0	33.0	107.0	50	Y380XT5/W309RX
	75	32		5/8-11UNC	1-1/4"	33.0	107.0	50	Y380XT6/W309RX
	75	32		1/2-12UNC	1"	33.0	107.0	50	Y380XT7/W309RX
	75	32		1/2-20UNF	25.0	33.0	107.0	50	Y380XT10/W309RX
	100	32		1/2-13UNC	1"	40.5	135.0	80	Y480XT2/W409RX
	100	32		M10 P1.5	25.0	40.5	135.0	80	Y480XT3/W409RX
	100	32		M12 P1.75	25.0	40.5	135.0	80	Y480XT4/W409RX
	100	32		M16 P2.0	25.0	40.5	135.0	80	Y480XT5/W409RX
	100	32		5/8-11UNC	1-1/4"	40.5	135.0	80	Y480XT6/W409RX
	100	32		1/2-12UNC	1"	40.5	135.0	80	Y480XT7/W409RX
	100	32		1/2-20UNF	25.0	40.5	135.0	80	Y480XT10/W409RX
	125	32		1/2-13UNC	1"	39.0	161.0	100	Y580XT2/W509RX
	125	32		M10 P1.5	25.0	39.0	161.0	100	Y580XT3/W509RX
125	32		M12 P1.75	25.0	39.0	161.0	100	Y580XT4/W509RX	
125	32		M16 P2.0	25.0	39.0	161.0	100	Y580XT5/W509RX	
125	32		5/8-11UNC	1-1/4"	39.0	161.0	100	Y580XT6/W509RX	
125	32		1/2-12UNC	1"	39.0	161.0	100	Y580XT7/W509RX	
125	32		1/2-20UNF	25.0	39.0	161.0	100	Y580XT10/W509RX	

































TB Total locking brake
 Total Lock system simultaneously locks both swivel head and wheel for a secure parking.
 Zinc-alloy brake pedal.

T Threaded Stem Fitting with Hex Base Washer



PM Wheel Solid nylon wheel

Brake type	 mm	 mm		 mm	 mm	 mm	 mm	 kg	Code
TB Total locking brake	75	32		1/2-13UNC	1"	41.0	107.0	50	Y380T2/W309RX
	75	32		M10 P1.5	25.0	41.0	107.0	50	Y380T3/W309RX
	75	32		M12 P1.75	25.0	41.0	107.0	50	Y380T4/W309RX
	75	32		M16 P2.0	25.0	41.0	107.0	50	Y380T5/W309RX
	75	32		5/8-11UNC	1-1/4"	41.0	107.0	50	Y380T6/W309RX
	75	32		1/2-12UNC	1"	41.0	107.0	50	Y380T7/W309RX
	75	32		1/2-20UNF	25.0	41.0	107.0	50	Y380T10/W309RX
	100	32		1/2-13UNC	1"	40.5	135.0	80	Y480T2/W409RX
	100	32		M10 P1.5	25.0	40.5	135.0	80	Y480T3/W409RX
	100	32		M12 P1.75	25.0	40.5	135.0	80	Y480T4/W409RX
	100	32		M16 P2.0	25.0	40.5	135.0	80	Y480T5/W409RX
	100	32		5/8-11UNC	1-1/4"	40.5	135.0	80	Y480T6/W409RX
	100	32		1/2-12UNC	1"	40.5	135.0	80	Y480T7/W409RX
	100	32		1/2-20UNF	25.0	40.5	135.0	80	Y480T10/W409RX
	125	32		1/2-13UNC	1"	39.0	161.0	100	Y580T2/W509RX
	125	32		M10 P1.5	25.0	39.0	161.0	100	Y580T3/W509RX
125	32		M12 P1.75	25.0	39.0	161.0	100	Y580T4/W509RX	
125	32		M16 P2.0	25.0	39.0	161.0	100	Y580T5/W509RX	
125	32		5/8-11UNC	1-1/4"	39.0	161.0	100	Y580T6/W509RX	
125	32		1/2-12UNC	1"	39.0	161.0	100	Y580T7/W509RX	
125	32		1/2-20UNF	25.0	39.0	161.0	100	Y580T10/W509RX	



Pressed steel, double ballrace swivel yoke, zinc-chromatized finish

Option: Bright chrome plated finish is also available, add suffix "-CR" to Catis code, e.g. Y580XP1/W503U-CR



TB/A Total locking brake

Total Lock system locks both swivel head and wheel simultaneously for secure parking. Integrated ON/OFF Nylon brake pedals for easy and quiet operation.































DB/A Directional locking brake

Directional Lock permits free wheel rotation while swivel head remains locked, an easy way to keep equipment traveling straight. Integrated ON/OFF Nylon brake pedals for easy and quiet operation. Release pedal in green color.

T Threaded Stem Fitting with Hex Base Washer



PM Wheel Solid nylon wheel

Brake type	 mm	 mm		 mm	 mm	 mm	 mm	 kg	Code
Non-brake Free swivel	75	32		1/2-13UNC	1"	33.0	107.0	50	Y381T2/W309RX
	75	32		M10 P1.5	25.0	33.0	107.0	50	Y381T3/W309RX
	75	32		M12 P1.75	25.0	33.0	107.0	50	Y381T4/W309RX
	75	32		M16 P2.0	25.0	33.0	107.0	50	Y381T5/W309RX
	75	32		5/8-11UNC	1-1/4"	33.0	107.0	50	Y381T6/W309RX
	75	32		1/2-12UNC	1"	33.0	107.0	50	Y381T7/W309RX
	75	32		1/2-20UNF	25.0	33.0	107.0	50	Y381T10/W309RX
	100	32		1/2-13UNC	1"	40.5	135.0	80	Y481T2/W409RX
	100	32		M10 P1.5	25.0	40.5	135.0	80	Y481T3/W409RX
	100	32		M12 P1.75	25.0	40.5	135.0	80	Y481T4/W409RX
100	32		M16 P2.0	25.0	40.5	135.0	80	Y481T5/W409RX	
100	32		5/8-11UNC	1-1/4"	40.5	135.0	80	Y481T6/W409RX	
100	32		1/2-12UNC	1"	40.5	135.0	80	Y481T7/W409RX	
100	32		1/2-20UNF	25.0	40.5	135.0	80	Y481T10/W409RX	
125	32		1/2-13UNC	1"	39.0	161.0	100	Y581T2/W509RX	
125	32		M10 P1.5	25.0	39.0	161.0	100	Y581T3/W509RX	
125	32		M12 P1.75	25.0	39.0	161.0	100	Y581T4/W509RX	
125	32		M16 P2.0	25.0	39.0	161.0	100	Y581T5/W509RX	
125	32		5/8-11UNC	1-1/4"	39.0	161.0	100	Y581T6/W509RX	
125	32		1/2-12UNC	1"	39.0	161.0	100	Y581T7/W509RX	
125	32		1/2-20UNF	25.0	39.0	161.0	100	Y581T10/W509RX	

































TB Total locking brake
 Total Lock system simultaneously locks both swivel head and wheel for a secure parking.
 Zinc-alloy brake pedal.

T Threaded Stem Fitting with Hex Base Washer



PP Wheel Solid polypropylene wheel

Brake type	 mm	 mm		 mm	 mm	 mm	 mm	 kg	Code
TB Total locking brake	75	32		1/2-13UNC	1"	33.0	107.0	50	Y380XT2/W310RX
	75	32		M10 P1.5	25.0	33.0	107.0	50	Y380XT3/W310RX
	75	32		M12 P1.75	25.0	33.0	107.0	50	Y380XT4/W310RX
	75	32		M16 P2.0	25.0	33.0	107.0	50	Y380XT5/W310RX
	75	32		5/8-11UNC	1-1/4"	33.0	107.0	50	Y380XT6/W310RX
	75	32		1/2-12UNC	1"	33.0	107.0	50	Y380XT7/W310RX
	75	32		1/2-20UNF	25.0	33.0	107.0	50	Y380XT10/W310RX
	100	32		1/2-13UNC	1"	40.5	135.0	80	Y480XT2/W410RX
	100	32		M10 P1.5	25.0	40.5	135.0	80	Y480XT3/W410RX
	100	32		M12 P1.75	25.0	40.5	135.0	80	Y480XT4/W410RX
	100	32		M16 P2.0	25.0	40.5	135.0	80	Y480XT5/W410RX
	100	32		5/8-11UNC	1-1/4"	40.5	135.0	80	Y480XT6/W410RX
	100	32		1/2-12UNC	1"	40.5	135.0	80	Y480XT7/W410RX
	100	32		1/2-20UNF	25.0	40.5	135.0	80	Y480XT10/W410RX
	125	32		1/2-13UNC	1"	39.0	161.0	100	Y580XT2/W510RX
	125	32		M10 P1.5	25.0	39.0	161.0	100	Y580XT3/W510RX
125	32		M12 P1.75	25.0	39.0	161.0	100	Y580XT4/W510RX	
125	32		M16 P2.0	25.0	39.0	161.0	100	Y580XT5/W510RX	
125	32		5/8-11UNC	1-1/4"	39.0	161.0	100	Y580XT6/W510RX	
125	32		1/2-12UNC	1"	39.0	161.0	100	Y580XT7/W510RX	
125	32		1/2-20UNF	25.0	39.0	161.0	100	Y580XT10/W510RX	



Pressed steel, double ballrace swivel yoke, zinc-chromatized finish

Option: Bright chrome plated finish is also available, add suffix "-CR" to Catis code, e.g. Y580XP1/W503U-CR



TB/A Total locking brake

Total Lock system locks both swivel head and wheel simultaneously for secure parking. Integrated ON/OFF Nylon brake pedals for easy and quiet operation.



DB/A Directional locking brake

Directional Lock permits free wheel rotation while swivel head remains locked, an easy way to keep equipment traveling straight. Integrated ON/OFF Nylon brake pedals for easy and quiet operation. Release pedal in green color.

T Threaded Stem Fitting with Hex Base Washer



PP Wheel Solid polypropylene wheel

Brake type	mm	mm		mm	mm	mm	mm	kg	Code
TB/B Total locking brake	75	32		1/2-13UNC	1"	41.0	107.0	50	Y380T2/W310RX
	75	32		M10 P1.5	25.0	41.0	107.0	50	Y380T3/W310RX
	75	32		M12 P1.75	25.0	41.0	107.0	50	Y380T4/W310RX
	75	32		M16 P2.0	25.0	41.0	107.0	50	Y380T5/W310RX
	75	32		5/8-11UNC	1-1/4"	41.0	107.0	50	Y380T6/W310RX
	75	32		1/2-12UNC	1"	41.0	107.0	50	Y380T7/W310RX
	75	32		1/2-20UNF	25.0	41.0	107.0	50	Y380T10/W310RX
	100	32		1/2-13UNC	1"	40.5	135.0	80	Y480T2/W410RX
	100	32		M10 P1.5	25.0	40.5	135.0	80	Y480T3/W410RX
	100	32		M12 P1.75	25.0	40.5	135.0	80	Y480T4/W410RX
	100	32		M16 P2.0	25.0	40.5	135.0	80	Y480T5/W410RX
	100	32		5/8-11UNC	1-1/4"	40.5	135.0	80	Y480T6/W410RX
	100	32		1/2-12UNC	1"	40.5	135.0	80	Y480T7/W410RX
	100	32		1/2-20UNF	25.0	40.5	135.0	80	Y480T10/W410RX
	125	32		1/2-13UNC	1"	39.0	161.0	100	Y580T2/W510RX
	125	32		M10 P1.5	25.0	39.0	161.0	100	Y580T3/W510RX
125	32		M12 P1.75	25.0	39.0	161.0	100	Y580T4/W510RX	
125	32		M16 P2.0	25.0	39.0	161.0	100	Y580T5/W510RX	
125	32		5/8-11UNC	1-1/4"	39.0	161.0	100	Y580T6/W510RX	
125	32		1/2-12UNC	1"	39.0	161.0	100	Y580T7/W510RX	
125	32		1/2-20UNF	25.0	39.0	161.0	100	Y580T10/W510RX	

































TB Total locking brake
 Total Lock system simultaneously locks both swivel head and wheel for a secure parking.
 Zinc-alloy brake pedal.

T Threaded Stem Fitting with Hex Base Washer



PP Wheel Solid polypropylene wheel

Brake type	 mm	 mm		 mm	 mm	 mm	 mm	 kg	Code
Non-brake Free swivel	75	32		1/2-13UNC	1"	33.0	107.0	50	Y381T2/W310RX
	75	32		M10 P1.5	25.0	33.0	107.0	50	Y381T3/W310RX
	75	32		M12 P1.75	25.0	33.0	107.0	50	Y381T4/W310RX
	75	32		M16 P2.0	25.0	33.0	107.0	50	Y381T5/W310RX
	75	32		5/8-11UNC	1-1/4"	33.0	107.0	50	Y381T6/W310RX
	75	32		1/2-12UNC	1"	33.0	107.0	50	Y381T7/W310RX
	75	32		1/2-20UNF	25.0	33.0	107.0	50	Y381T10/W310RX
	100	32		1/2-13UNC	1"	40.5	135.0	80	Y481T2/W410RX
	100	32		M10 P1.5	25.0	40.5	135.0	80	Y481T3/W410RX
	100	32		M12 P1.75	25.0	40.5	135.0	80	Y481T4/W410RX
	100	32		M16 P2.0	25.0	40.5	135.0	80	Y481T5/W410RX
	100	32		5/8-11UNC	1-1/4"	40.5	135.0	80	Y481T6/W410RX
100	32		1/2-12UNC	1"	40.5	135.0	80	Y481T7/W410RX	
100	32		1/2-20UNF	25.0	40.5	135.0	80	Y481T10/W410RX	
125	32		1/2-13UNC	1"	39.0	161.0	100	Y581T2/W510RX	
125	32		M10 P1.5	25.0	39.0	161.0	100	Y581T3/W510RX	
125	32		M12 P1.75	25.0	39.0	161.0	100	Y581T4/W510RX	
125	32		M16 P2.0	25.0	39.0	161.0	100	Y581T5/W510RX	
125	32		5/8-11UNC	1-1/4"	39.0	161.0	100	Y581T6/W510RX	
125	32		1/2-12UNC	1"	39.0	161.0	100	Y581T7/W510RX	
125	32		1/2-20UNF	25.0	39.0	161.0	100	Y581T10/W510RX	



Pressed steel, double ballrace swivel yoke, zinc-chromatized finish

Option: Bright chrome plated finish is also available, add suffix "-CR" to Catis code, e.g. Y580XP1/W503U-CR



TB/A Total locking brake
Total Lock system locks both swivel head and wheel simultaneously for secure parking. Integrated ON/OFF Nylon brake pedals for easy and quiet operation.



DB/A Directional locking brake
Directional Lock permits free wheel rotation while swivel head remains locked, an easy way to keep equipment traveling straight. Integrated ON/OFF Nylon brake pedals for easy and quiet operation. Release pedal in green color.

H Bolt Hole Fitting

PRB Wheel Plastic hub, grey color elastic rubber tire



























Brake type	mm	mm		mm	mm	mm	kg	Code		
TB/A Total locking brake	75	32		10.3	33.0	104.5	50	Y380XH1/W324		
	75	32		12.3	33.0	104.5	50	Y380XH2/W324		
	75	32		12.8	33.0	104.5	50	Y380XH3/W324		
	TB/B Total locking brake	100	32		10.3	40.5	132.5	80	Y480XH1/W424	
		100	32		12.3	40.5	132.5	80	Y480XH2/W424	
		100	32		12.8	40.5	132.5	80	Y480XH3/W424	
		125	32		10.3	39.0	158.5	100	Y580XH1/W524	
			32		12.3	39.0	158.5	100	Y580XH2/W524	
			32		12.8	39.0	158.5	100	Y580XH3/W524	
150		32		10.3	50.0	187.0	100	Y680XH1/W624		
		32		12.3	50.0	187.0	100	Y680XH2/W624		
		32		12.8	50.0	187.0	100	Y680XH3/W624		
TB/B Total locking brake	75	32		10.3	41.0	104.5	50	Y380H1/W324		
	75	32		12.3	41.0	104.5	50	Y380H2/W324		
	75	32		12.8	41.0	104.5	50	Y380H3/W324		
	100	32		10.3	40.5	132.5	80	Y480H1/W424		
		32		12.3	40.5	132.5	80	Y480H2/W424		
		32		12.8	40.5	132.5	80	Y480H3/W424		
	125	32		10.3	39.0	158.5	100	Y580H1/W524		
		32		12.3	39.0	158.5	100	Y580H2/W524		
		32		12.8	39.0	158.5	100	Y580H3/W524		
150	32		10.3	46.5	187.0	100	Y680H1/W624			
	32		12.3	46.5	187.0	100	Y680H2/W624			



TB Total locking brake
 Total Lock system simultaneously locks both swivel head and wheel for a secure parking.
 Zinc-alloy brake pedal.

H Bolt Hole Fitting

PRB Wheel Plastic hub, grey color elastic rubber tire

Brake type	 mm	 mm		 mm	 mm	 mm	 kg	Code
DB Dir. locking brake	100	32		10.3	40.5	132.5	80	Y480XDH1/W424
	100	32		12.3	40.5	132.5	80	Y480XDH2/W424
	100	32		12.8	40.5	132.5	80	Y480XDH3/W424
	125	32		10.3	39.0	158.5	100	Y580XDH1/W524
	125	32		12.3	39.0	158.5	100	Y580XDH2/W524
	125	32		12.8	39.0	158.5	100	Y580XDH3/W524
	150	32		10.3	50.0	187.0	100	Y680XDH1/W624
	150	32		12.3	50.0	187.0	100	Y680XDH2/W624
	150	32		12.8	50.0	187.0	100	Y680XDH3/W624
Non-brake Free swivel	75	32		10.3	33.0	104.5	50	Y381H1/W324
	75	32		12.3	33.0	104.5	50	Y381H2/W324
	75	32		12.8	33.0	104.5	50	Y381H3/W324
	100	32		10.3	40.5	132.5	80	Y481H1/W424
	100	32		12.3	40.5	132.5	80	Y481H2/W424
	100	32		12.8	40.5	132.5	80	Y481H3/W424
	125	32		10.3	39.0	158.5	100	Y581H1/W524
	125	32		12.3	39.0	158.5	100	Y581H2/W524
	125	32		12.8	39.0	158.5	100	Y581H3/W524
	150	32		10.3	50.0	187.0	100	Y681H1/W624
	150	32		12.3	50.0	187.0	100	Y681H2/W624
	150	32		12.8	50.0	187.0	100	Y681H3/W624



Pressed steel, double ballrace swivel yoke, zinc-chromatized finish

Option: Bright chrome plated finish is also available, add suffix "-CR" to Catis code, e.g. Y580XP1/W503U-CR



























TB/A Total locking brake
Total Lock system locks both swivel head and wheel simultaneously for secure parking. Integrated ON/OFF Nylon brake pedals for easy and quiet operation.



DB/A Directional locking brake
Directional Lock permits free wheel rotation while swivel head remains locked, an easy way to keep equipment traveling straight. Integrated ON/OFF Nylon brake pedals for easy and quiet operation. Release pedal in green color.

H Bolt Hole Fitting

SRB Wheel Pressed steel hub, grey color elastic rubber tire

Brake type	 mm	 mm		 mm	 mm	 mm	 kg	Code
TB/A Total locking brake	100	32		10.3	40.5	132.5	80	Y480XH1/W423
	100	32		12.3	40.5	132.5	80	Y480XH2/W423
	100	32		12.8	40.5	132.5	80	Y480XH3/W423
	125	32		10.3	39.0	158.5	100	Y580XH1/W523
	125	32		12.3	39.0	158.5	100	Y580XH2/W523
	125	32		12.8	39.0	158.5	100	Y580XH3/W523
	150	32		10.3	50.0	187.0	100	Y680XH1/W623
	150	32		12.3	50.0	187.0	100	Y680XH2/W623
	150	32		12.8	50.0	187.0	100	Y680XH3/W623
TB/B Total locking brake	100	32		10.3	40.5	132.5	80	Y480H1/W423
	100	32		12.3	40.5	132.5	80	Y480H2/W423
	100	32		12.8	40.5	132.5	80	Y480H3/W423
	125	32		10.3	39.0	158.5	100	Y580H1/W523
	125	32		12.3	39.0	158.5	100	Y580H2/W523
	125	32		12.8	39.0	158.5	100	Y580H3/W523
	150	32		10.3	46.5	187.0	100	Y680H1/W623
	150	32		12.3	46.5	187.0	100	Y680H2/W623
	150	32		12.8	46.5	187.0	100	Y680H3/W623





TB/B Total locking brake
 Total Lock system simultaneously locks both swivel head and wheel for a secure parking.
 Zinc-alloy brake pedal.

H Bolt Hole Fitting

SRB Wheel Pressed steel hub, grey color elastic rubber tire

Brake type	mm	mm		mm	mm	mm	kg	Code
DB/A Dir. locking brake	100	32		10.3	40.5	132.5	80	Y480XDH1/W423
	100	32		12.3	40.5	132.5	80	Y480XDH2/W423
	100	32		12.8	40.5	132.5	80	Y480XDH3/W423
	125	32		10.3	39.0	158.5	100	Y580XDH1/W523
	125	32		12.3	39.0	158.5	100	Y580XDH2/W523
	125	32		12.8	39.0	158.5	100	Y580XDH3/W523
	150	32		10.3	50.0	187.0	100	Y680XDH1/W623
	150	32		12.3	50.0	187.0	100	Y680XDH2/W623
	150	32		12.8	50.0	187.0	100	Y680XDH3/W623
Non-brake Free swivel	100	32		10.3	40.5	132.5	80	Y481H1/W423
	100	32		12.3	40.5	132.5	80	Y481H2/W423
	100	32		12.8	40.5	132.5	80	Y481H3/W423
	125	32		10.3	39.0	158.5	100	Y581H1/W523
	125	32		12.3	39.0	158.5	100	Y581H2/W523
	125	32		12.8	39.0	158.5	100	Y581H3/W523
	150	32		10.3	50.0	187.0	100	Y681H1/W623
	150	32		12.3	50.0	187.0	100	Y681H2/W623
	150	32		12.8	50.0	187.0	100	Y681H3/W623



SRB/BKAS Wheel Conductive wheels are also available

		Code
Pressed steel hub and threadguards, zinc-chromatized finish, black color conductive rubber tire Add suffix "-CR" to Catis code for bright chrome finish	100 x 32mm	W423-BKAS
	125 x 32mm	W523-BKAS
	150 x 32mm	W623-BKAS



Electrical Resistance $\leq 10^4 \Omega$

Pressed steel, double ballrace swivel yoke, zinc-chromatized finish

Option: Bright chrome plated finish is also available, add suffix "-CR" to Catis code, e.g. Y580XP1/W503U-CR













TB Total locking brake
Total Lock system locks both swivel head and wheel simultaneously for secure parking. Integrated ON/OFF Nylon brake pedals for easy and quiet operation.



DB Directional locking brake
Directional Lock permits free wheel rotation while swivel head remains locked, an easy way to keep equipment traveling straight. Integrated ON/OFF Nylon brake pedals for easy and quiet operation. Release pedal in green color.

H Bolt Hole Fitting

TPR Wheel Plastic hub, grey color thermoplastic rubber tire

Brake type	 mm	 mm		 mm	 mm	 mm	 kg	Code
TB Total locking brake	75	25		10.3	30.0	104.5	45	Y360H1/W312
	75	25		12.3	30.0	104.5	45	Y360H2/W312
	75	25		12.8	30.0	104.5	45	Y360H3/W312
	100	25		10.3	38.5	132.5	60	Y460H1/W412
	100	25		12.3	38.5	132.5	60	Y460H2/W412
	100	25		12.8	38.5	132.5	60	Y460H3/W412
	125	25		10.3	38.5	158.5	70	Y560H1/W512
	125	25		12.3	38.5	158.5	70	Y560H2/W512
	125	25		12.8	38.5	158.5	70	Y560H3/W512
	100	32		10.3	40.5	132.5	80	Y480XH1/W403
	100	32		12.3	40.5	132.5	80	Y480XH2/W403
	100	32		12.8	40.5	132.5	80	Y480XH3/W403
	125	32		10.3	39.0	158.5	100	Y580XH1/W503
	125	32		12.3	39.0	158.5	100	Y580XH2/W503
	125	32		12.8	39.0	158.5	100	Y580XH3/W503
	125	32		10.3	39.0	158.5	100	Y580XH1/W503U
	125	32		12.3	39.0	158.5	100	Y580XH2/W503U
	125	32		12.8	39.0	158.5	100	Y580XH3/W503U
150	32		10.3	50.0	187.0	100	Y680XH1/W603U	
150	32		12.3	50.0	187.0	100	Y680XH2/W603U	
150	32		12.8	50.0	187.0	100	Y680XH3/W603U	



































TB/3 Total locking brake
 Total Lock system simultaneously locks both swivel head and wheel for a secure parking.
 Zinc-alloy brake pedal.

H Bolt Hole Fitting

TPR Wheel Plastic hub, grey color thermoplastic rubber tire

Brake type	 mm	 mm		 mm	 mm	 mm	 kg	Code
TB/3 Total locking brake	100	32		10.3	40.5	132.5	80	Y480H1/W403
	100	32		12.3	40.5	132.5	80	Y480H2/W403
	100	32		12.8	40.5	132.5	80	Y480H3/W403
	125	32		10.3	39.0	158.5	100	Y580H1/W503
	125	32		12.3	39.0	158.5	100	Y580H2/W503
	125	32		12.8	39.0	158.5	100	Y580H3/W503
	125	32		10.3	39.0	158.5	100	Y580H1/W503U
	125	32		12.3	39.0	158.5	100	Y580H2/W503U
	125	32		12.8	39.0	158.5	100	Y580H3/W503U
	150	32		10.3	46.5	187.0	100	Y680H1/W603U
150	32		12.3	46.5	187.0	100	Y680H2/W603U	
150	32		12.8	46.5	187.0	100	Y680H3/W603U	
DB/4 Dir. locking brake	100	32		10.3	40.5	132.5	80	Y480XDH1/W403
	100	32		12.3	40.5	132.5	80	Y480XDH2/W403
	100	32		12.8	40.5	132.5	80	Y480XDH3/W403
	125	32		10.3	39.0	158.5	100	Y580XDH1/W503
	125	32		12.3	39.0	158.5	100	Y580XDH2/W503
	125	32		12.8	39.0	158.5	100	Y580XDH3/W503
	125	32		10.3	39.0	158.5	100	Y580XDH1/W503U
	125	32		12.3	39.0	158.5	100	Y580XDH2/W503U
	125	32		12.8	39.0	158.5	100	Y580XDH3/W503U
	150	32		10.3	50.0	187.0	100	Y680XDH1/W603U
	150	32		12.3	50.0	187.0	100	Y680XDH2/W603U
	150	32		12.8	50.0	187.0	100	Y680XDH3/W603U



Pressed steel, double ballrace swivel yoke, zinc-chromatized finish

Option: Bright chrome plated finish is also available, add suffix "-CR" to Catis code, e.g. Y580XP1/W503U-CR



TB/A Total locking brake
Total Lock system locks both swivel head and wheel simultaneously for secure parking. Integrated ON/OFF Nylon brake pedals for easy and quiet operation.

























DB/A Directional locking brake
Directional Lock permits free wheel rotation while swivel head remains locked, an easy way to keep equipment traveling straight. Integrated ON/OFF Nylon brake pedals for easy and quiet operation. Release pedal in green color.

H Bolt Hole Fitting



TPR Wheel Plastic hub, grey color thermoplastic rubber tire

Brake type	 mm	 mm		 mm	 mm	 mm	 kg	Code
Non-brake Free swivel	75	25		10.3	30.0	104.5	45	Y361H1/W312
	75	25		12.3	30.0	104.5	45	Y361H2/W312
	75	25		12.8	30.0	104.5	45	Y361H3/W312
	100	25		10.3	38.5	132.5	60	Y461H1/W412
	100	25		12.3	38.5	132.5	60	Y461H2/W412
	100	25		12.8	38.5	132.5	60	Y461H3/W412
	125	25		10.3	38.5	158.5	70	Y561H1/W512
	125	25		12.3	38.5	158.5	70	Y561H2/W512
	125	25		12.8	38.5	158.5	70	Y561H3/W512
Non-brake Free swivel	100	32		10.3	40.5	132.5	80	Y481H1/W403
	100	32		12.3	40.5	132.5	80	Y481H2/W403
	100	32		12.8	40.5	132.5	80	Y481H3/W403
	125	32		10.3	39.0	158.5	100	Y581H1/W503
	125	32		12.3	39.0	158.5	100	Y581H2/W503
	125	32		12.8	39.0	158.5	100	Y581H3/W503





TB Total locking brake
 Total Lock system simultaneously locks both swivel head and wheel for a secure parking.
 Zinc-alloy brake pedal.

H Bolt Hole Fitting

TPR Wheel Plastic hub, grey color thermoplastic rubber tire

Brake type	mm	mm		mm	mm	mm	kg	Code
Non-brake Free swivel	125	32		10.3	39.0	158.5	100	Y581H1/W503U
	125	32		12.3	39.0	158.5	100	Y581H2/W503U
	125	32		12.8	39.0	158.5	100	Y581H3/W503U
	150	32		10.3	50.0	187.0	100	Y681H1/W603U
	150	32		12.3	50.0	187.0	100	Y681H2/W603U
	150	32		12.8	50.0	187.0	100	Y681H3/W603U



TPR/AS Wheel Conductive wheels are also available

		Code
Plastic hub and threadguards, grey color conductive thermoplastic rubber tire	075 x 25mm	W303CX-AS*
	100 x 32mm	W403-AS
	125 x 32mm	W503-AS
	150 x 32mm	W603U-AS



*Wheel with metal threadguards (see P020)

Electrical Resistance $\leq 10^4 \Omega$

Pressed steel, double ballrace swivel yoke, zinc-chromatized finish

Option: Bright chrome plated finish is also available, add suffix "-CR" to Catis code, e.g. Y580XP1/W503U-CR



TB/A Total locking brake

Total Lock system locks both swivel head and wheel simultaneously for secure parking. Integrated ON/OFF Nylon brake pedals for easy and quiet operation.



DB/A Directional locking brake

Directional Lock permits free wheel rotation while swivel head remains locked, an easy way to keep equipment traveling straight. Integrated ON/OFF Nylon brake pedals for easy and quiet operation. Release pedal in green color.

H Bolt Hole Fitting



TPU Wheel Plastic hub, grey color polyurethane tire

Brake type	mm	mm		mm	mm	mm	kg	Code
TB/A Total locking brake	75	32		10.3	33.0	104.5	50	Y380XH1/W300
	75	32		12.3	33.0	104.5	50	Y380XH2/W300
	75	32		12.8	33.0	104.5	50	Y380XH3/W300
	100	32		10.3	40.5	132.5	80	Y480XH1/W400E
	100	32		12.3	40.5	132.5	80	Y480XH2/W400E
	100	32		12.8	40.5	132.5	80	Y480XH3/W400E
	125	32		10.3	39.0	158.5	100	Y580XH1/W500E
	125	32		12.3	39.0	158.5	100	Y580XH2/W500E
	125	32		12.8	39.0	158.5	100	Y580XH3/W500E
TB/B Total locking brake	75	32		10.3	41.0	104.5	50	Y380H1/W300
	75	32		12.3	41.0	104.5	50	Y380H2/W300
	75	32		12.8	41.0	104.5	50	Y380H3/W300
	100	32		10.3	40.5	132.5	80	Y480H1/W400E
	100	32		12.3	40.5	132.5	80	Y480H2/W400E
	100	32		12.8	40.5	132.5	80	Y480H3/W400E
	125	32		10.3	39.0	158.5	100	Y580H1/W500E
	125	32		12.3	39.0	158.5	100	Y580H2/W500E
	125	32		12.8	39.0	158.5	100	Y580H3/W500E
	150	32		10.3	46.5	187.0	100	Y680H1/W600E
	150	32		12.3	46.5	187.0	100	Y680H2/W600E
	150	32		12.8	46.5	187.0	100	Y680H3/W600E





TB Total locking brake
 Total Lock system simultaneously locks both swivel head and wheel for a secure parking.
 Zinc-alloy brake pedal.

H Bolt Hole Fitting

TPU Wheel Plastic hub, grey color polyurethane tire

Brake type	mm	mm		mm	mm	kg	Code	
DB Dir. locking brake	100	32		10.3	40.5	132.5	80	Y480XDH1/W400E
	100	32		12.3	40.5	132.5	80	Y480XDH2/W400E
	100	32		12.8	40.5	132.5	80	Y480XDH3/W400E
	125	32		10.3	39.0	158.5	100	Y580XDH1/W500E
	125	32		12.3	39.0	158.5	100	Y580XDH2/W500E
	125	32		12.8	39.0	158.5	100	Y580XDH3/W500E
	150	32		10.3	50.0	187.0	100	Y680XDH1/W600E
	150	32		12.3	50.0	187.0	100	Y680XDH2/W600E
	150	32		12.8	50.0	187.0	100	Y680XDH3/W600E
Non-brake Free swivel	75	32		10.3	33.0	104.5	50	Y381H1/W300
	75	32		12.3	33.0	104.5	50	Y381H2/W300
	75	32		12.8	33.0	104.5	50	Y381H3/W300
	100	32		10.3	40.5	132.5	80	Y481H1/W400E
	100	32		12.3	40.5	132.5	80	Y481H2/W400E
	100	32		12.8	40.5	132.5	80	Y481H3/W400E
	125	32		10.3	39.0	158.5	100	Y581H1/W500E
	125	32		12.3	39.0	158.5	100	Y581H2/W500E
	125	32		12.8	39.0	158.5	100	Y581H3/W500E
	150	32		10.3	50.0	187.0	100	Y681H1/W600E
	150	32		12.3	50.0	187.0	100	Y681H2/W600E
	150	32		12.8	50.0	187.0	100	Y681H3/W600E



Pressed steel, double ballrace swivel yoke, zinc-chromatized finish

Option: Bright chrome plated finish is also available, add suffix "-CR" to Catis code, e.g. Y580XP1/W503U-CR



TB/A Total locking brake
Total Lock system locks both swivel head and wheel simultaneously for secure parking. Integrated ON/OFF Nylon brake pedals for easy and quiet operation.



DB/A Directional locking brake
Directional Lock permits free wheel rotation while swivel head remains locked, an easy way to keep equipment traveling straight. Integrated ON/OFF Nylon brake pedals for easy and quiet operation. Release pedal in green color.

H Bolt Hole Fitting



PM Wheel Solid nylon wheel

Brake type	mm	mm		mm	mm	mm	kg	Code
TB/A Total locking brake	75	32		10.3	33.0	104.5	50	Y380XH1/W309RX
	75	32		12.3	33.0	104.5	50	Y380XH2/W309RX
	75	32		12.8	33.0	104.5	50	Y380XH3/W309RX
	100	32		10.3	40.5	132.5	80	Y480XH1/W409RX
	100	32		12.3	40.5	132.5	80	Y480XH2/W409RX
	100	32		12.8	40.5	132.5	80	Y480XH3/W409RX
	125	32		10.3	39.0	158.5	100	Y580XH1/W509RX
	125	32		12.3	39.0	158.5	100	Y580XH2/W509RX
	125	32		12.8	39.0	158.5	100	Y580XH3/W509RX
TB/B Total locking brake	75	32		10.3	41.0	104.5	50	Y380H1/W309RX
	75	32		12.3	41.0	104.5	50	Y380H2/W309RX
	75	32		12.8	41.0	104.5	50	Y380H3/W309RX
	100	32		10.3	40.5	132.5	80	Y480H1/W409RX
	100	32		12.3	40.5	132.5	80	Y480H2/W409RX
	100	32		12.8	40.5	132.5	80	Y480H3/W409RX
	125	32		10.3	39.0	158.5	100	Y580H1/W509RX
	125	32		12.3	39.0	158.5	100	Y580H2/W509RX
	125	32		12.8	39.0	158.5	100	Y580H3/W509RX





TB Total locking brake
 Total Lock system simultaneously locks both swivel head and wheel for a secure parking.
 Zinc-alloy brake pedal.

H Bolt Hole Fitting



PM Wheel Solid nylon wheel

Brake type	mm	mm		mm	mm	mm	kg	Code
DB Dir. locking brake	100	32		10.3	40.5	132.5	80	Y480XDH1/W409RX
	100	32		12.3	40.5	132.5	80	Y480XDH2/W409RX
	100	32		12.8	40.5	132.5	80	Y480XDH3/W409RX
	125	32		10.3	39.0	158.5	100	Y580XDH1/W509RX
	125	32		12.3	39.0	158.5	100	Y580XDH2/W509RX
	125	32		12.8	39.0	158.5	100	Y580XDH3/W509RX
Non-brake Free swivel	75	32		10.3	33.0	104.5	50	Y381H1/W309RX
	75	32		12.3	33.0	104.5	50	Y381H2/W309RX
	75	32		12.8	33.0	104.5	50	Y381H3/W309RX
	100	32		10.3	40.5	132.5	80	Y481H1/W409RX
	100	32		12.3	40.5	132.5	80	Y481H2/W409RX
	100	32		12.8	40.5	132.5	80	Y481H3/W409RX
	125	32		10.3	39.0	158.5	100	Y581H1/W509RX
	125	32		12.3	39.0	158.5	100	Y581H2/W509RX
	125	32		12.8	39.0	158.5	100	Y581H3/W509RX



Pressed steel, double ballrace swivel yoke, zinc-chromatized finish

Option: Bright chrome plated finish is also available, add suffix "-CR" to Catis code, e.g. Y580XP1/W503U-CR



TB/A Total locking brake
Total Lock system locks both swivel head and wheel simultaneously for secure parking. Integrated ON/OFF Nylon brake pedals for easy and quiet operation.



DB/A Directional locking brake
Directional Lock permits free wheel rotation while swivel head remains locked, an easy way to keep equipment traveling straight. Integrated ON/OFF Nylon brake pedals for easy and quiet operation. Release pedal in green color.

H Bolt Hole Fitting



PP Wheel Solid polypropylene wheel

Brake type	mm	mm		mm	mm	mm	kg	Code
TB/A Total locking brake	75	32		10.3	33.0	104.5	50	Y380XH1/W310RX
	75	32		12.3	33.0	104.5	50	Y380XH2/W310RX
	75	32		12.8	33.0	104.5	50	Y380XH3/W310RX
	100	32		10.3	40.5	132.5	80	Y480XH1/W410RX
	100	32		12.3	40.5	132.5	80	Y480XH2/W410RX
	100	32		12.8	40.5	132.5	80	Y480XH3/W410RX
	125	32		10.3	39.0	158.5	100	Y580XH1/W510RX
	125	32		12.3	39.0	158.5	100	Y580XH2/W510RX
	125	32		12.8	39.0	158.5	100	Y580XH3/W510RX
TB/B Total locking brake	75	32		10.3	41.0	104.5	50	Y380H1/W310RX
	75	32		12.3	41.0	104.5	50	Y380H2/W310RX
	75	32		12.8	41.0	104.5	50	Y380H3/W310RX
	100	32		10.3	40.5	132.5	80	Y480H1/W410RX
	100	32		12.3	40.5	132.5	80	Y480H2/W410RX
	100	32		12.8	40.5	132.5	80	Y480H3/W410RX
	125	32		10.3	39.0	158.5	100	Y580H1/W510RX
	125	32		12.3	39.0	158.5	100	Y580H2/W510RX
	125	32		12.8	39.0	158.5	100	Y580H3/W510RX





TB Total locking brake
 Total Lock system simultaneously locks both swivel head and wheel for a secure parking.
 Zinc-alloy brake pedal.

H Bolt Hole Fitting



PP Wheel Solid polypropylene wheel

Brake type	mm	mm		mm	mm	mm	kg	Code
DB Dir. locking brake	100	32		10.3	40.5	132.5	80	Y480XDH1/W410RX
	100	32		12.3	40.5	132.5	80	Y480XDH2/W410RX
	100	32		12.8	40.5	132.5	80	Y480XDH3/W410RX
	125	32		10.3	39.0	158.5	100	Y580XDH1/W510RX
	125	32		12.3	39.0	158.5	100	Y580XDH2/W510RX
	125	32		12.8	39.0	158.5	100	Y580XDH3/W510RX
Non-brake Free swivel	75	32		10.3	33.0	104.5	50	Y381H1/W310RX
	75	32		12.3	33.0	104.5	50	Y381H2/W310RX
	75	32		12.8	33.0	104.5	50	Y381H3/W310RX
	100	32		10.3	40.5	132.5	80	Y481H1/W410RX
	100	32		12.3	40.5	132.5	80	Y481H2/W410RX
	100	32		12.8	40.5	132.5	80	Y481H3/W410RX
	125	32		10.3	39.0	158.5	100	Y581H1/W510RX
	125	32		12.3	39.0	158.5	100	Y581H2/W510RX
	125	32		12.8	39.0	158.5	100	Y581H3/W510RX



Pressed steel, double ballrace swivel yoke, zinc-chromatized finish

Option: Bright chrome plated finish is also available, add suffix "-CR" to Catis code, e.g. Y580XP1/W503U-CR



TB/A Total locking brake
Total Lock system locks both swivel head and wheel simultaneously for secure parking. Integrated ON/OFF Nylon brake pedals for easy and quiet operation.



DB/A Directional locking brake
Directional Lock permits free wheel rotation while swivel head remains locked, an easy way to keep equipment traveling straight. Integrated ON/OFF Nylon brake pedals for easy and quiet operation. Release pedal in green color.

F Friction Ring Stem

TPR Wheel Plastic hub, grey color thermoplastic rubber tire

Brake type	mm	mm		mm	mm	mm	mm	mm	mm	mm	kg	Code
TB/A Total locking brake	75	25		11.1	12.0	35.2	25.4	1.6	30.0	107.0	45	Y360F5/W312
	100	32		21.5	23.0	55.0	45.2	2.4	40.5	135.0	80	Y480XF3/W403
	125	32		21.5	23.0	55.0	45.2	2.4	39.0	161.0	100	Y580XF3/W503
	125	32		21.5	23.0	55.0	45.2	2.4	39.0	161.0	100	Y580XF3/W503U
	150	32		21.5	23.0	55.0	45.2	2.4	50.0	189.5	100	Y680XF3/W603U
TB/B Total locking brake	100	32		21.5	23.0	55.0	45.2	2.4	40.5	135.0	80	Y480F3/W403
	125	32		21.5	23.0	55.0	45.2	2.4	39.0	161.0	100	Y580F3/W503
	125	32		21.5	23.0	55.0	45.2	2.4	39.0	161.0	100	Y580F3/W503U
	150	32		21.5	23.0	55.0	45.2	2.4	46.5	189.5	100	Y680F3/W603U
Non-brake Free swivel	75	25		11.1	12.0	35.2	25.4	1.6	30.0	107.0	45	Y361F5/W312
	100	32		21.5	23.0	55.0	45.2	2.4	40.5	135.0	80	Y481F3/W403
	125	32		21.5	23.0	55.0	45.2	2.4	39.0	161.0	100	Y581F3/W503
	125	32		21.5	23.0	55.0	45.2	2.4	39.0	161.0	100	Y581F3/W503U
	150	32		21.5	23.0	55.0	45.2	2.4	50.0	189.5	100	Y681F3/W603U





TB Total locking brake
 Total Lock system simultaneously locks both swivel head and wheel for a secure parking.
 Zinc-alloy brake pedal.

F Friction Ring Stem

TPU Wheel Plastic hub, grey color polyurethane tire

Brake type	mm	mm		mm	mm	mm	mm	mm	mm	mm	mm	kg	Code	
TB Total locking brake	100	32		21.5	23.0	55.0	45.2	2.4	40.5	135.0	80		Y480XF3/W400E	
	125	32		21.5	23.0	55.0	45.2	2.4	39.0	161.0	100		Y580XF3/W500E	
	150	32		21.5	23.0	55.0	45.2	2.4	50.0	189.5	100		Y680XF3/W600E	
TB Total locking brake	100	32		21.5	23.0	55.0	45.2	2.4	40.5	135.0	80		Y480F3/W400E	
	125	32		21.5	23.0	55.0	45.2	2.4	39.0	161.0	100		Y580F3/W500E	
	150	32		21.5	23.0	55.0	45.2	2.4	46.5	189.5	100		Y680F3/W600E	
Non-brake Free swivel	100	32		21.5	23.0	55.0	45.2	2.4	40.5	135.0	80		Y481F3/W400E	
	125	32		21.5	23.0	55.0	45.2	2.4	39.0	161.0	100		Y581F3/W500E	
	150	32		21.5	23.0	55.0	45.2	2.4	50.0	189.5	100		Y681F3/W600E	





DURARO

Stainless Steel Castors

Application:

Kitchen trolleys; food carts; food processing plants; restaurants and commercial kitchens; laboratory equipments.

Size Available:

75x32, 100x32, 125x32, 150x32, 200x32mm

If your mobile equipment is subjected to frequent contact or exposure to moisture, our Duraro would be your absolute choice of castor.

For the same reason, it is a must for most kitchen and food carts which are constantly moved in and out of refrigerating room and steamy kitchen, then hose cleaned to rid of food debris and oil stain, nothing other than stainless steel can stay shiny under such adverse conditions.

On the other extreme, medical or laboratory equipments that has to be sanitized with disinfectants would find Duraro suitable at all time.

Pressed stainless steel double ballrace swivel yoke, electrolytic polishing finish



TB Total locking brake
Total Lock system locks both swivel head and wheel simultaneously for secure parking. Integrated ON/OFF Nylon brake pedals for easy and quiet operation.



DB Directional locking brake
Directional Lock permits free wheel rotation while swivel head remains locked, an easy way to keep equipment traveling straight. Integrated ON/OFF Nylon brake pedals for easy and quiet operation. Release pedal in green color.

P Top Plate Fitting

PRB-SS Wheel Plastic hub, grey color elastic rubber tire

Brake type	mm	mm		mm	mm	mm	mm	mm	kg	Code
TB Total locking brake	75	32		95 x 70	75 x 52 / 72 x 45	9.0	33.0	107.0	50	Y380XP1SS/W324S
	75	32		77 x 67	61.5 x 52 / 56 x 45	8.5	33.0	107.0	50	Y380XP2SS/W324S
	100	32		95 x 70	75 x 52 / 72 x 45	9.0	40.5	135.0	80	Y480XP1SS/W424DS
	100	32		77 x 67	61.5 x 52 / 56 x 45	8.5	40.5	135.0	80	Y480XP2SS/W424DS
	125	32		95 x 70	75 x 52 / 72 x 45	9.0	39.0	161.0	100	Y580XP1SS/W524DS
	125	32		77 x 67	61.5 x 52 / 56 x 45	8.5	39.0	161.0	100	Y580XP2SS/W524DS
	150	32		95 x 70	75 x 52 / 72 x 45	9.0	50.0	189.5	100	Y680XP1SS/W624DS
	150	32		77 x 67	61.5 x 52 / 56 x 45	8.5	50.0	189.5	100	Y680XP2SS/W624DS
TB Total locking brake	75	32		95 x 70	75 x 52 / 72 x 45	9.0	41.0	107.0	50	Y380P1SS/W324S
	75	32		77 x 67	61.5 x 52 / 56 x 45	8.5	41.0	107.0	50	Y380P2SS/W324S
	100	32		95 x 70	75 x 52 / 72 x 45	9.0	40.5	135.0	80	Y480P1SS/W424DS
	100	32		77 x 67	61.5 x 52 / 56 x 45	8.5	40.5	135.0	80	Y480P2SS/W424DS
	125	32		95 x 70	75 x 52 / 72 x 45	9.0	39.0	161.0	100	Y580P1SS/W524DS
	125	32		77 x 67	61.5 x 52 / 56 x 45	8.5	39.0	161.0	100	Y580P2SS/W524DS
	150	32		95 x 70	75 x 52 / 72 x 45	9.0	46.5	189.5	100	Y680P1SS/W624DS
	150	32		77 x 67	61.5 x 52 / 56 x 45	8.5	46.5	189.5	100	Y680P2SS/W624DS

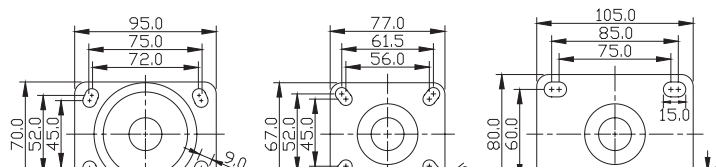























TB Total locking brake
 Total Lock system simultaneously locks both swivel head and wheel for a secure parking.
 Zinc-alloy brake pedal.

P Top Plate Fitting

PRB-SS Wheel Plastic hub, grey color elastic rubber tire

Brake type	mm	mm		mm	mm	mm	mm	mm	kg	Code
DB Dir. locking brake	75	32		95 x 70	75 x 52 / 72 x 45	9.0	33.0	107.0	50	Y380XDP1SS/W324S
	75	32		77 x 67	61.5 x 52 / 56 x 45	8.5	33.0	107.0	50	Y380XDP2SS/W324S
	100	32		95 x 70	75 x 52 / 72 x 45	9.0	40.5	135.0	80	Y480XDP1SS/W424DS
	100	32		77 x 67	61.5 x 52 / 56 x 45	8.5	40.5	135.0	80	Y480XDP2SS/W424DS
	125	32		95 x 70	75 x 52 / 72 x 45	9.0	39.0	161.0	100	Y580XDP1SS/W524DS
	125	32		77 x 67	61.5 x 52 / 56 x 45	8.5	39.0	161.0	100	Y580XDP2SS/W524DS
	150	32		95 x 70	75 x 52 / 72 x 45	9.0	50.0	189.5	100	Y680XDP1SS/W624DS
	150	32		77 x 67	61.5 x 52 / 56 x 45	8.5	50.0	189.5	100	Y680XDP2SS/W624DS
Non-brake Free swivel	75	32		95 x 70	75 x 52 / 72 x 45	9.0	33.0	107.0	50	Y381P1SS/W324S
	75	32		77 x 67	61.5 x 52 / 56 x 45	8.5	33.0	107.0	50	Y381P2SS/W324S
	75	32		105 x 80	85 x 60 / 75 x 60	10.0	33.0	107.0	50	Y381P3SS/W324S
	100	32		95 x 70	75 x 52 / 72 x 45	9.0	40.5	135.0	80	Y481P1SS/W424DS
	100	32		77 x 67	61.5 x 52 / 56 x 45	8.5	40.5	135.0	80	Y481P2SS/W424DS
	100	32		105 x 80	85 x 60 / 75 x 60	10.0	40.5	135.0	80	Y481P3SS/W424DS
	125	32		95 x 70	75 x 52 / 72 x 45	9.0	39.0	161.0	100	Y581P1SS/W524DS
	125	32		77 x 67	61.5 x 52 / 56 x 45	8.5	39.0	161.0	100	Y581P2SS/W524DS
	125	32		105 x 80	85 x 60 / 75 x 60	10.0	39.0	161.0	100	Y581P3SS/W524DS
	150	32		95 x 70	75 x 52 / 72 x 45	9.0	50.0	189.5	100	Y681P1SS/W624DS
	150	32		77 x 67	61.5 x 52 / 56 x 45	8.5	50.0	189.5	100	Y681P2SS/W624DS
	150	32		105 x 80	85 x 60 / 75 x 60	10.0	50.0	189.5	100	Y681P3SS/W624DS



 Stainless steel

Pressed stainless steel double ballrace swivel yoke, electrolytic polishing finish



TB/A Total locking brake
Total Lock system locks both swivel head and wheel simultaneously for secure parking. Integrated ON/OFF Nylon brake pedals for easy and quiet operation.



DB/A Directional locking brake
Directional Lock permits free wheel rotation while swivel head remains locked, an easy way to keep equipment traveling straight. Integrated ON/OFF Nylon brake pedals for easy and quiet operation. Release pedal in green color.

P Top Plate Fitting

PRB-SS Wheel Plastic hub, grey color elastic rubber tire

Brake type	mm	mm	mm	mm	mm	mm	mm	kg	Code
Non-brake Fixed	75	32		95 x 77	75 x 52 / 72 x 45	9.0	107.0	50	Y382P1SS/W324S
	100	32		95 x 77	75 x 52 / 72 x 45	9.0	135.0	80	Y482P1SS/W424DS
	125	32		95 x 77	75 x 52 / 72 x 45	9.0	161.0	100	Y582P1SS/W524DS
	150	32		95 x 77	75 x 52 / 72 x 45	9.0	189.5	100	Y682P1SS/W624DS
	75	32		67 x 77	52 x 61.5 / 45 x 56	8.5	107.0	50	Y385P2SS/W324S
	100	32		67 x 77	52 x 61.5 / 45 x 56	8.5	135.0	80	Y485P2SS/W424DS
	125	32		67 x 77	52 x 61.5 / 45 x 56	8.5	161.0	100	Y585P2SS/W524DS

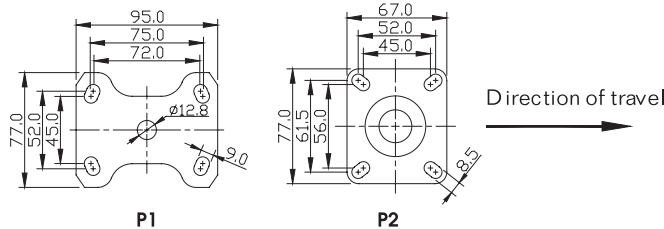



TB/ Total locking brake
 Total Lock system simultaneously locks both swivel head and wheel for a secure parking.
 Zinc-alloy brake pedal.

P Top Plate Fitting

TPR-SS Wheel Plastic hub, grey color thermoplastic rubber tire

Brake type	mm	mm		mm	mm	mm	mm	mm	kg	Code
TB/ Total locking brake	100	32		95 x 70	75 x 52 / 72 x 45	9.0	40.5	135.0	80	Y480XP1SS/W403DS
	100	32		77 x 67	61.5 x 52 / 56 x 45	8.5	40.5	135.0	80	Y480XP2SS/W403DS
	125	32		95 x 70	75 x 52 / 72 x 45	9.0	39.0	161.0	100	Y580XP1SS/W503DS
	125	32		77 x 67	61.5 x 52 / 56 x 45	8.5	39.0	161.0	100	Y580XP2SS/W503DS
	200	32		95 x 70	75 x 52 / 72 x 45	9.0	57.5	235.0	120	Y880XP1SS/W803UXS
TB/ Total locking brake	100	32		95 x 70	75 x 52 / 72 x 45	9.0	40.5	135.0	80	Y480P1SS/W403DS
	100	32		77 x 67	61.5 x 52 / 56 x 45	8.5	40.5	135.0	80	Y480P2SS/W403DS
	125	32		95 x 70	75 x 52 / 72 x 45	9.0	39.0	161.0	100	Y580P1SS/W503DS
	125	32		77 x 67	61.5 x 52 / 56 x 45	8.5	39.0	161.0	100	Y580P2SS/W503DS
DB/ Dir. locking brake	100	32		95 x 70	75 x 52 / 72 x 45	9.0	40.5	135.0	80	Y480XD1SS/W403DS
	100	32		77 x 67	61.5 x 52 / 56 x 45	8.5	40.5	135.0	80	Y480XD2SS/W403DS
	125	32		95 x 70	75 x 52 / 72 x 45	9.0	39.0	161.0	100	Y580XD1SS/W503DS
	125	32		77 x 67	61.5 x 52 / 56 x 45	8.5	39.0	161.0	100	Y580XD2SS/W503DS
	200	32		95 x 70	75 x 52 / 72 x 45	9.0	57.5	235.0	120	Y880XD1SS/W803UXS



Stainless steel

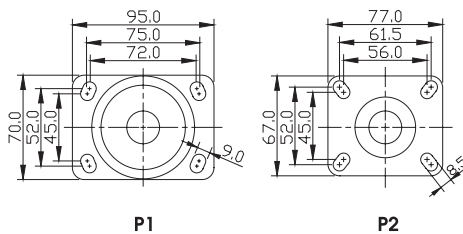

Pressed stainless steel double ballrace swivel yoke, electrolytic polishing finish



TB/A Total locking brake
Total Lock system locks both swivel head and wheel simultaneously for secure parking. Integrated ON/OFF Nylon brake pedals for easy and quiet operation.



DB/A Directional locking brake
Directional Lock permits free wheel rotation while swivel head remains locked, an easy way to keep equipment traveling straight. Integrated ON/OFF Nylon brake pedals for easy and quiet operation. Release pedal in green color.

P Top Plate Fitting

TPR-SS Wheel Plastic hub, grey color thermoplastic rubber tire

Brake type	mm	mm	mm	mm	mm	mm	mm	mm	kg	Code
Non-brake Free swivel	100	32		95 x 70	75 x 52 / 72 x 45	9.0	40.5	135.0	80	Y481P1SS/W403DS
	100	32		77 x 67	61.5 x 52 / 56 x 45	8.5	40.5	135.0	80	Y481P2SS/W403DS
	100	32		105 x 80	85 x 60 / 75 x 60	10.0	40.5	135.0	80	Y481P3SS/W403DS
	125	32		95 x 70	75 x 52 / 72 x 45	9.0	39.0	161.0	100	Y581P1SS/W503DS
	125	32		77 x 67	61.5 x 52 / 56 x 45	8.5	39.0	161.0	100	Y581P2SS/W503DS
	125	32		105 x 80	85 x 60 / 75 x 60	10.0	39.0	161.0	100	Y581P3SS/W503DS
	200	32		95 x 70	75 x 52 / 72 x 45	9.0	57.5	235.0	120	Y881P1SS/W803UXS



Brake type	mm	mm	mm	mm	mm	mm	mm	kg	Code
Non-brake Fixed	100	32		95 x 77	75 x 52 / 72 x 45	9.0	135.0	80	Y482P1SS/W403DS
	125	32		95 x 77	75 x 52 / 72 x 45	9.0	161.0	100	Y582P1SS/W503DS
	100	32		67 x 77	52 x 61.5 / 45 x 56	8.5	135.0	80	Y485P2SS/W403DS
	125	32		67 x 77	52 x 61.5 / 45 x 56	8.5	161.0	100	Y585P2SS/W503DS



TPR-SS/AS Wheel Conductive wheels are also available

Plastic hub, grey color conductive thermoplastic rubber tire, stainless steel ball bearings, stainless steel threadguards

	Code
100 x 32mm	W403DS-AS
125 x 32mm	W503DS-AS



Electrical Resistance $\leq 10^4 \Omega$



TB/SS Total locking brake
 Total Lock system simultaneously locks both swivel head and wheel for a secure parking.
 Zinc-alloy brake pedal.

P Top Plate Fitting

TPU-SS Wheel Plastic hub, grey color polyurethane tire

Brake type	mm	mm	mm	mm	mm	mm	mm	mm	kg	Code
TB/SS Total locking brake	75	32		95 x 70	75 x 52 / 72 x 45	9.0	33.0	107.0	50	Y380XP1SS/W300S
	75	32		77 x 67	61.5 x 52 / 56 x 45	8.5	33.0	107.0	50	Y380XP2SS/W300S
	100	32		95 x 70	75 x 52 / 72 x 45	9.0	40.5	135.0	80	Y480XP1SS/W400DS
	100	32		77 x 67	61.5 x 52 / 56 x 45	8.5	40.5	135.0	80	Y480XP2SS/W400DS
	125	32		95 x 70	75 x 52 / 72 x 45	9.0	39.0	161.0	100	Y580XP1SS/W500DS
	125	32		77 x 67	61.5 x 52 / 56 x 45	8.5	39.0	161.0	100	Y580XP2SS/W500DS
	150	32		95 x 70	75 x 52 / 72 x 45	9.0	50.0	189.5	100	Y680XP1SS/W600DS
	150	32		77 x 67	61.5 x 52 / 56 x 45	8.5	50.0	189.5	100	Y680XP2SS/W600DS
TB/SS Total locking brake	75	32		95 x 70	75 x 52 / 72 x 45	9.0	41.0	107.0	50	Y380P1SS/W300S
	75	32		77 x 67	61.5 x 52 / 56 x 45	8.5	41.0	107.0	50	Y380P2SS/W300S
	100	32		95 x 70	75 x 52 / 72 x 45	9.0	40.5	135.0	80	Y480P1SS/W400DS
	100	32		77 x 67	61.5 x 52 / 56 x 45	8.5	40.5	135.0	80	Y480P2SS/W400DS
	125	32		95 x 70	75 x 52 / 72 x 45	9.0	39.0	161.0	100	Y580P1SS/W500DS
	125	32		77 x 67	61.5 x 52 / 56 x 45	8.5	39.0	161.0	100	Y580P2SS/W500DS
	150	32		95 x 70	75 x 52 / 72 x 45	9.0	46.5	189.5	100	Y680P1SS/W600DS
	150	32		77 x 67	61.5 x 52 / 56 x 45	8.5	46.5	189.5	100	Y680P2SS/W600DS



Stainless steel

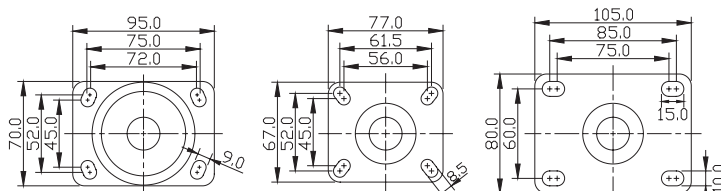

Pressed stainless steel double ballrace swivel yoke, electrolytic polishing finish



TB/A Total locking brake
Total Lock system locks both swivel head and wheel simultaneously for secure parking. Integrated ON/OFF Nylon brake pedals for easy and quiet operation.



DB/A Directional locking brake
Directional Lock permits free wheel rotation while swivel head remains locked, an easy way to keep equipment traveling straight. Integrated ON/OFF Nylon brake pedals for easy and quiet operation. Release pedal in green color.

P Top Plate Fitting

TPU-SS Wheel Plastic hub, grey color polyurethane tire

Brake type	mm	mm		mm	mm	mm	mm	mm	kg	Code	
DB/A Dir. locking brake	75	32		95 x 70	75 x 52 / 72 x 45	9.0	33.0	107.0	50	Y380XDP1SS/W300S	
	75	32		77 x 67	61.5 x 52 / 56 x 45	8.5	33.0	107.0	50	Y380XDP2SS/W300S	
	100	32		95 x 70	75 x 52 / 72 x 45	9.0	40.5	135.0	80	Y480XDP1SS/W400DS	
	100	32		77 x 67	61.5 x 52 / 56 x 45	8.5	40.5	135.0	80	Y480XDP2SS/W400DS	
	125	32		95 x 70	75 x 52 / 72 x 45	9.0	39.0	161.0	100	Y580XDP1SS/W500DS	
	125	32		77 x 67	61.5 x 52 / 56 x 45	8.5	39.0	161.0	100	Y580XDP2SS/W500DS	
	150	32		95 x 70	75 x 52 / 72 x 45	9.0	50.0	189.5	100	Y680XDP1SS/W600DS	
	150	32		77 x 67	61.5 x 52 / 56 x 45	8.5	50.0	189.5	100	Y680XDP2SS/W600DS	
	Non-brake Free swivel	75	32		95 x 70	75 x 52 / 72 x 45	9.0	33.0	107.0	50	Y381P1SS/W300S
		75	32		77 x 67	61.5 x 52 / 56 x 45	8.5	33.0	107.0	50	Y381P2SS/W300S
		75	32		105 x 80	85 x 60 / 75 x 60	10.0	33.0	107.0	50	Y381P3SS/W300S
		100	32		95 x 70	75 x 52 / 72 x 45	9.0	40.5	135.0	80	Y481P1SS/W400DS
100		32		77 x 67	61.5 x 52 / 56 x 45	8.5	40.5	135.0	80	Y481P2SS/W400DS	
100		32		105 x 80	85 x 60 / 75 x 60	10.0	40.5	135.0	80	Y481P3SS/W400DS	
125		32		95 x 70	75 x 52 / 72 x 45	9.0	39.0	161.0	100	Y581P1SS/W500DS	
125		32		77 x 67	61.5 x 52 / 56 x 45	8.5	39.0	161.0	100	Y581P2SS/W500DS	
125		32		105 x 80	85 x 60 / 75 x 60	10.0	39.0	161.0	100	Y581P3SS/W500DS	
150		32		95 x 70	75 x 52 / 72 x 45	9.0	50.0	189.5	100	Y681P1SS/W600DS	
150		32		77 x 67	61.5 x 52 / 56 x 45	8.5	50.0	189.5	100	Y681P2SS/W600DS	
150		32		105 x 80	85 x 60 / 75 x 60	10.0	50.0	189.5	100	Y681P3SS/W600DS	





TB Total locking brake
 Total Lock system simultaneously locks both swivel head and wheel for a secure parking.
 Zinc-alloy brake pedal.

P Top Plate Fitting

TPU-SS Wheel Plastic hub, grey color polyurethane tire

Brake type	mm	mm		mm	mm	mm	mm	kg	Code	
Non-brake Fixed	75	32		95 x 77	75 x 52 / 72 x 45	9.0	107.0	50	Y382P1SS/W300S	
	100	32		95 x 77	75 x 52 / 72 x 45	9.0	135.0	80	Y482P1SS/W400DS	
	125	32		95 x 77	75 x 52 / 72 x 45	9.0	161.0	100	Y582P1SS/W500DS	
	150	32		95 x 77	75 x 52 / 72 x 45	9.0	189.5	100	Y682P1SS/W600DS	
	75	32		67 x 77	52 x 61.5 / 45 x 56	8.5	107.0	50	Y385P2SS/W300S	
	100	32		67 x 77	52 x 61.5 / 45 x 56	8.5	135.0	80	Y485P2SS/W400DS	
	125	32		67 x 77	52 x 61.5 / 45 x 56	8.5	161.0	100	Y585P2SS/W500DS	

Stainless steel

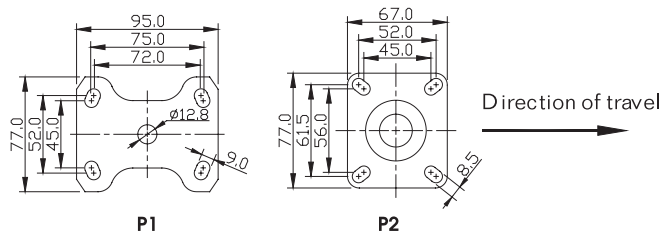

Pressed stainless steel double ballrace swivel yoke, electrolytic polishing finish



TB/A Total locking brake
Total Lock system locks both swivel head and wheel simultaneously for secure parking. Integrated ON/OFF Nylon brake pedals for easy and quiet operation.



DB/A Directional locking brake
Directional Lock permits free wheel rotation while swivel head remains locked, an easy way to keep equipment traveling straight. Integrated ON/OFF Nylon brake pedals for easy and quiet operation. Release pedal in green color.

P Top Plate Fitting

PM-SS Wheel Solid nylon wheel, stainless steel roller bearing, stainless steel threadguards

Brake type	mm	mm		mm	mm	mm	mm	mm	kg	Code
TB/A Total locking brake	75	32		95 x 70	75 x 52 / 72 x 45	9.0	33.0	107.0	50	Y380XP1SS/W309RXS
	75	32		77 x 67	61.5 x 52 / 56 x 45	8.5	33.0	107.0	50	Y380XP2SS/W309RXS
	100	32		95 x 70	75 x 52 / 72 x 45	9.0	40.5	135.0	80	Y480XP1SS/W409RXS
	100	32		77 x 67	61.5 x 52 / 56 x 45	8.5	40.5	135.0	80	Y480XP2SS/W409RXS
	125	32		95 x 70	75 x 52 / 72 x 45	9.0	39.0	161.0	100	Y580XP1SS/W509RXS
	125	32		77 x 67	61.5 x 52 / 56 x 45	8.5	39.0	161.0	100	Y580XP2SS/W509RXS
TB/B Total locking brake	75	32		95 x 70	75 x 52 / 72 x 45	9.0	41.0	107.0	50	Y380P1SS/W309RXS
	75	32		77 x 67	61.5 x 52 / 56 x 45	8.5	41.0	107.0	50	Y380P2SS/W309RXS
	100	32		95 x 70	75 x 52 / 72 x 45	9.0	40.5	135.0	80	Y480P1SS/W409RXS
	100	32		77 x 67	61.5 x 52 / 56 x 45	8.5	40.5	135.0	80	Y480P2SS/W409RXS
	125	32		95 x 70	75 x 52 / 72 x 45	9.0	39.0	161.0	100	Y580P1SS/W509RXS
	125	32		77 x 67	61.5 x 52 / 56 x 45	8.5	39.0	161.0	100	Y580P2SS/W509RXS
DB/A Dir. locking brake	75	32		95 x 70	75 x 52 / 72 x 45	9.0	33.0	107.0	50	Y380XDP1SS/W309RXS
	75	32		77 x 67	61.5 x 52 / 56 x 45	8.5	33.0	107.0	50	Y380XDP2SS/W309RXS
	100	32		95 x 70	75 x 52 / 72 x 45	9.0	40.5	135.0	80	Y480XDP1SS/W409RXS
	100	32		77 x 67	61.5 x 52 / 56 x 45	8.5	40.5	135.0	80	Y480XDP2SS/W409RXS
	125	32		95 x 70	75 x 52 / 72 x 45	9.0	39.0	161.0	100	Y580XDP1SS/W509RXS
	125	32		77 x 67	61.5 x 52 / 56 x 45	8.5	39.0	161.0	100	Y580XDP2SS/W509RXS

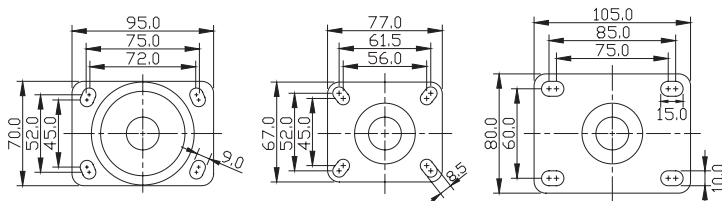



TB Total locking brake
 Total Lock system simultaneously locks both swivel head and wheel for a secure parking.
 Zinc-alloy brake pedal.

P Top Plate Fitting



PM-SS Wheel Solid nylon wheel, stainless steel roller bearing, stainless steel threadguards

Brake type	mm	mm		mm	mm	mm	mm	mm	kg	Code
Non-brake Free swivel	75	32		95 x 70	75 x 52 / 72 x 45	9.0	33.0	107.0	50	Y381P1SS/W309RXS
	75	32		77 x 67	61.5 x 52 / 56 x 45	8.5	33.0	107.0	50	Y381P2SS/W309RXS
	75	32		105 x 80	85 x 60 / 75 x 60	10.0	33.0	107.0	50	Y381P3SS/W309RXS
	100	32		95 x 70	75 x 52 / 72 x 45	9.0	40.5	135.0	80	Y481P1SS/W409RXS
	100	32		77 x 67	61.5 x 52 / 56 x 45	8.5	40.5	135.0	80	Y481P2SS/W409RXS
	100	32		105 x 80	85 x 60 / 75 x 60	10.0	40.5	135.0	80	Y481P3SS/W409RXS
	125	32		95 x 70	75 x 52 / 72 x 45	9.0	39.0	161.0	100	Y581P1SS/W509RXS
	125	32		77 x 67	61.5 x 52 / 56 x 45	8.5	39.0	161.0	100	Y581P2SS/W509RXS
125	32		105 x 80	85 x 60 / 75 x 60	10.0	39.0	161.0	100	Y581P3SS/W509RXS	



Brake type	mm	mm		mm	mm	mm	mm	mm	kg	Code
Non-brake Fixed	75	32		95 x 77	75 x 52 / 72 x 45	9.0	107.0	50	Y382P1SS/W309RXS	
	100	32		95 x 77	75 x 52 / 72 x 45	9.0	135.0	80	Y482P1SS/W409RXS	
	125	32		95 x 77	75 x 52 / 72 x 45	9.0	161.0	100	Y582P1SS/W509RXS	
	75	32		67 x 77	52 x 61.5 / 45 x 56	8.5	107.0	50	Y385P2SS/W309RXS	
	100	32		67 x 77	52 x 61.5 / 45 x 56	8.5	135.0	80	Y485P2SS/W409RXS	
	125	32		67 x 77	52 x 61.5 / 45 x 56	8.5	161.0	100	Y585P2SS/W509RXS	



Stainless steel

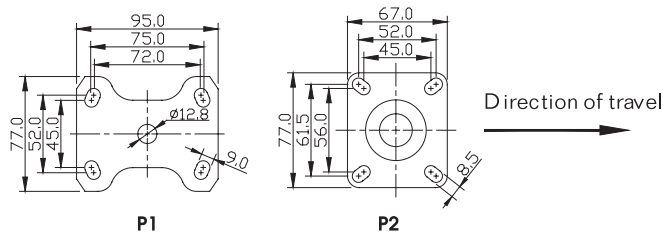

Pressed stainless steel double ballrace swivel yoke, electrolytic polishing finish



TB/A Total locking brake
Total Lock system locks both swivel head and wheel simultaneously for secure parking. Integrated ON/OFF Nylon brake pedals for easy and quiet operation.



DB/A Directional locking brake
Directional Lock permits free wheel rotation while swivel head remains locked, an easy way to keep equipment traveling straight. Integrated ON/OFF Nylon brake pedals for easy and quiet operation. Release pedal in green color.

T Threaded Stem Fitting with Hex Base Washer

PRB-SS Wheel Plastic hub, grey color elastic rubber tire

Brake type	mm	mm		mm	mm	mm	mm	kg	Code
TB/A Total locking brake	75	32		1/2-13UNC	1"	33.0	107.0	50	Y380XT2SS/W324S
	75	32		M12 P1.75	25.0	33.0	107.0	50	Y380XT4SS/W324S
	75	32		M16 P2.0	25.0	33.0	107.0	50	Y380XT5SS/W324S
	100	32		1/2-13UNC	1"	40.5	135.0	80	Y480XT2SS/W424DS
	100	32		M12 P1.75	25.0	40.5	135.0	80	Y480XT4SS/W424DS
	100	32		M16 P2.0	25.0	40.5	135.0	80	Y480XT5SS/W424DS
	125	32		1/2-13UNC	1"	39.0	161.0	100	Y580XT2SS/W524DS
	125	32		M12 P1.75	25.0	39.0	161.0	100	Y580XT4SS/W524DS
	125	32		M16 P2.0	25.0	39.0	161.0	100	Y580XT5SS/W524DS
TB/B Total locking brake	75	32		1/2-13UNC	1"	41.0	107.0	50	Y380T2SS/W324S
	75	32		M12 P1.75	25.0	41.0	107.0	50	Y380T4SS/W324S
	75	32		M16 P2.0	25.0	41.0	107.0	50	Y380T5SS/W324S
	100	32		1/2-13UNC	1"	40.5	135.0	80	Y480T2SS/W424DS
	100	32		M12 P1.75	25.0	40.5	135.0	80	Y480T4SS/W424DS
	100	32		M16 P2.0	25.0	40.5	135.0	80	Y480T5SS/W424DS
	125	32		1/2-13UNC	1"	39.0	161.0	100	Y580T2SS/W524DS
	125	32		M12 P1.75	25.0	39.0	161.0	100	Y580T4SS/W524DS
	125	32		M16 P2.0	25.0	39.0	161.0	100	Y580T5SS/W524DS
150	32		1/2-13UNC	1"	46.5	189.5	100	Y680T2SS/W624DS	
150	32		M12 P1.75	25.0	46.5	189.5	100	Y680T4SS/W624DS	
150	32		M16 P2.0	25.0	46.5	189.5	100	Y680T5SS/W624DS	

























TLB Total locking brake
 Total Lock system simultaneously locks both swivel head and wheel for a secure parking.
 Zinc-alloy brake pedal.

T Threaded Stem Fitting with Hex Base Washer

PRB-SS Wheel Plastic hub, grey color elastic rubber tire

Brake type	 mm	 mm		 mm	 mm	 mm	 mm	 kg	Code
Non-brake Free swivel	75	32		1/2-13UNC	1"	33.0	107.0	50	Y381T2SS/W324S
	75	32		M12 P1.75	25.0	33.0	107.0	50	Y381T4SS/W324S
	75	32		M16 P2.0	25.0	33.0	107.0	50	Y381T5SS/W324S
	100	32		1/2-13UNC	1"	40.5	135.0	80	Y481T2SS/W424DS
	100	32		M12 P1.75	25.0	40.5	135.0	80	Y481T4SS/W424DS
	100	32		M16 P2.0	25.0	40.5	135.0	80	Y481T5SS/W424DS
	125	32		1/2-13UNC	1"	39.0	161.0	100	Y581T2SS/W524DS
	125	32		M12 P1.75	25.0	39.0	161.0	100	Y581T4SS/W524DS
	125	32		M16 P2.0	25.0	39.0	161.0	100	Y581T5SS/W524DS
	150	32		1/2-13UNC	1"	50.0	189.5	100	Y681T2SS/W624DS
	150	32		M12 P1.75	25.0	50.0	189.5	100	Y681T4SS/W624DS
	150	32		M16 P2.0	25.0	50.0	189.5	100	Y681T5SS/W624DS



 Stainless steel

Pressed stainless steel double ballrace swivel yoke, electrolytic polishing finish



TB/A Total locking brake
Total Lock system locks both swivel head and wheel simultaneously for secure parking. Integrated ON/OFF Nylon brake pedals for easy and quiet operation.



DB/A Directional locking brake
Directional Lock permits free wheel rotation while swivel head remains locked, an easy way to keep equipment traveling straight. Integrated ON/OFF Nylon brake pedals for easy and quiet operation. Release pedal in green color.

T Threaded Stem Fitting with Hex Base Washer

TPR-SS Wheel Plastic hub, grey color thermoplastic rubber tire

Brake type	mm	mm		mm	mm	mm	mm	kg	Code
TB/A Total locking brake	100	32		1/2-13UNC	1"	40.5	135.0	80	Y480XT2SS/W403DS
	100	32		M12 P1.75	25.0	40.5	135.0	80	Y480XT4SS/W403DS
	100	32		M16 P2.0	25.0	40.5	135.0	80	Y480XT5SS/W403DS
	125	32		1/2-13UNC	1"	39.0	161.0	100	Y580XT2SS/W503DS
	125	32		M12 P1.75	25.0	39.0	161.0	100	Y580XT4SS/W503DS
	125	32		M16 P2.0	25.0	39.0	161.0	100	Y580XT5SS/W503DS
TB/B Total locking brake	100	32		1/2-13UNC	1"	40.5	135.0	80	Y480T2SS/W403DS
	100	32		M12 P1.75	25.0	40.5	135.0	80	Y480T4SS/W403DS
	100	32		M16 P2.0	25.0	40.5	135.0	80	Y480T5SS/W403DS
	125	32		1/2-13UNC	1"	39.0	161.0	100	Y580T2SS/W503DS
	125	32		M12 P1.75	25.0	39.0	161.0	100	Y580T4SS/W503DS
	125	32		M16 P2.0	25.0	39.0	161.0	100	Y580T5SS/W503DS



















TB Total locking brake
 Total Lock system simultaneously locks both swivel head and wheel for a secure parking.
 Zinc-alloy brake pedal.

T Threaded Stem Fitting with Hex Base Washer

TPR-SS Wheel Plastic hub, grey color thermoplastic rubber tire

Brake type	 mm	 mm		 mm	 mm	 mm	 mm	 kg	Code
Non-brake Free swivel	100	32		1/2-13UNC	1"	40.5	135.0	80	Y481T2SS/W403DS
	100	32		M12 P1.75	25.0	40.5	135.0	80	Y481T4SS/W403DS
	100	32		M16 P2.0	25.0	40.5	135.0	80	Y481T5SS/W403DS
	125	32		1/2-13UNC	1"	39.0	161.0	100	Y581T2SS/W503DS
	125	32		M12 P1.75	25.0	39.0	161.0	100	Y581T4SS/W503DS
	125	32		M16 P2.0	25.0	39.0	161.0	100	Y581T5SS/W503DS



TPR-SS/AS Wheel Conductive wheels are also available

		Code
Plastic hub, grey color conductive thermoplastic rubber tire, stainless steel ball bearings, stainless steel threadguards	100 x 32mm	W403DS-AS
	125 x 32mm	W503DS-AS



Electrical Resistance $\leq 10^4 \Omega$

 Stainless steel

Pressed stainless steel double ballrace swivel yoke, electrolytic polishing finish



TB/A Total locking brake
Total Lock system locks both swivel head and wheel simultaneously for secure parking. Integrated ON/OFF Nylon brake pedals for easy and quiet operation.



DB/A Directional locking brake
Directional Lock permits free wheel rotation while swivel head remains locked, an easy way to keep equipment traveling straight. Integrated ON/OFF Nylon brake pedals for easy and quiet operation. Release pedal in green color.

T Threaded Stem Fitting with Hex Base Washer

TPU-SS Wheel Plastic hub, grey color polyurethane tire

Brake type	mm	mm		mm	mm	mm	mm	kg	Code
TB/A Total locking brake	75	32		1/2-13UNC	1"	33.0	107.0	50	Y380XT2SS/W300S
	75	32		M12 P1.75	25.0	33.0	107.0	50	Y380XT4SS/W300S
	75	32		M16 P2.0	25.0	33.0	107.0	50	Y380XT5SS/W300S
	100	32		1/2-13UNC	1"	40.5	135.0	80	Y480XT2SS/W400DS
	100	32		M12 P1.75	25.0	40.5	135.0	80	Y480XT4SS/W400DS
	100	32		M16 P2.0	25.0	40.5	135.0	80	Y480XT5SS/W400DS
	125	32		1/2-13UNC	1"	39.0	161.0	100	Y580XT2SS/W500DS
	125	32		M12 P1.75	25.0	39.0	161.0	100	Y580XT4SS/W500DS
	125	32		M16 P2.0	25.0	39.0	161.0	100	Y580XT5SS/W500DS
TB/B Total locking brake	75	32		1/2-13UNC	1"	41.0	107.0	50	Y380T2SS/W300S
	75	32		M12 P1.75	25.0	41.0	107.0	50	Y380T4SS/W300S
	75	32		M16 P2.0	25.0	41.0	107.0	50	Y380T5SS/W300S
	100	32		1/2-13UNC	1"	40.5	135.0	80	Y480T2SS/W400DS
	100	32		M12 P1.75	25.0	40.5	135.0	80	Y480T4SS/W400DS
	100	32		M16 P2.0	25.0	40.5	135.0	80	Y480T5SS/W400DS
	125	32		1/2-13UNC	1"	39.0	161.0	100	Y580T2SS/W500DS
	125	32		M12 P1.75	25.0	39.0	161.0	100	Y580T4SS/W500DS
	125	32		M16 P2.0	25.0	39.0	161.0	100	Y580T5SS/W500DS
TB/B Total locking brake	150	32		1/2-13UNC	1"	46.5	189.5	100	Y680T2SS/W600DS
	150	32		M12 P1.75	25.0	46.5	189.5	100	Y680T4SS/W600DS
	150	32		M16 P2.0	25.0	46.5	189.5	100	Y680T5SS/W600DS

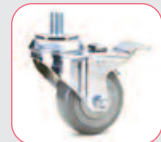























TLB Total locking brake
 Total Lock system simultaneously locks both swivel head and wheel for a secure parking.
 Zinc-alloy brake pedal.

T Threaded Stem Fitting with Hex Base Washer

TPU-SS Wheel Plastic hub, grey color polyurethane tire

Brake type	 mm	 mm		 mm	 mm	 mm	 mm	 kg	Code
Non-brake Free swivel	75	32		1/2-13UNC	1"	33.0	107.0	50	Y381T2SS/W300S
	75	32		M12 P1.75	25.0	33.0	107.0	50	Y381T4SS/W300S
	75	32		M16 P2.0	25.0	33.0	107.0	50	Y381T5SS/W300S
	100	32		1/2-13UNC	1"	40.5	135.0	80	Y481T2SS/W400DS
	100	32		M12 P1.75	25.0	40.5	135.0	80	Y481T4SS/W400DS
	100	32		M16 P2.0	25.0	40.5	135.0	80	Y481T5SS/W400DS
	125	32		1/2-13UNC	1"	39.0	161.0	100	Y581T2SS/W500DS
	125	32		M12 P1.75	25.0	39.0	161.0	100	Y581T4SS/W500DS
	125	32		M16 P2.0	25.0	39.0	161.0	100	Y581T5SS/W500DS
	150	32		1/2-13UNC	1"	50.0	189.5	100	Y681T2SS/W600DS
	150	32		M12 P1.75	25.0	50.0	189.5	100	Y681T4SS/W600DS
	150	32		M16 P2.0	25.0	50.0	189.5	100	Y681T5SS/W600DS



 Stainless steel

Pressed stainless steel double ballrace swivel yoke, electrolytic polishing finish



TB/A Total locking brake
Total Lock system locks both swivel head and wheel simultaneously for secure parking. Integrated ON/OFF Nylon brake pedals for easy and quiet operation.





























DB/A Directional locking brake
Directional Lock permits free wheel rotation while swivel head remains locked, an easy way to keep equipment traveling straight. Integrated ON/OFF Nylon brake pedals for easy and quiet operation. Release pedal in green color.

T Threaded Stem Fitting with Hex Base Washer



PM-SS Wheel

Solid nylon wheel, stainless steel roller bearing, stainless steel threadguards

Brake type	 mm	 mm		 mm	 mm	 mm	 mm	 kg	Code
TB/A Total locking brake	75	32		1/2-13UNC	1"	33.0	107.0	50	Y380XT2SS/W309RXS
	75	32		M12 P1.75	25.0	33.0	107.0	50	Y380XT4SS/W309RXS
	75	32		M16 P2.0	25.0	33.0	107.0	50	Y380XT5SS/W309RXS
	100	32		1/2-13UNC	1"	40.5	135.0	80	Y480XT2SS/W409RXS
	100	32		M12 P1.75	25.0	40.5	135.0	80	Y480XT4SS/W409RXS
	100	32		M16 P2.0	25.0	40.5	135.0	80	Y480XT5SS/W409RXS
	125	32		1/2-13UNC	1"	39.0	161.0	100	Y580XT2SS/W509RXS
	125	32		M12 P1.75	25.0	39.0	161.0	100	Y580XT4SS/W509RXS
125	32		M16 P2.0	25.0	39.0	161.0	100	Y580XT5SS/W509RXS	
TB/B Total locking brake	75	32		1/2-13UNC	1"	41.0	107.0	50	Y380T2SS/W309RXS
	75	32		M12 P1.75	25.0	41.0	107.0	50	Y380T4SS/W309RXS
	75	32		M16 P2.0	25.0	41.0	107.0	50	Y380T5SS/W309RXS
	100	32		1/2-13UNC	1"	40.5	135.0	80	Y480T2SS/W409RXS
	100	32		M12 P1.75	25.0	40.5	135.0	80	Y480T4SS/W409RXS
	100	32		M16 P2.0	25.0	40.5	135.0	80	Y480T5SS/W409RXS
	125	32		1/2-13UNC	1"	39.0	161.0	100	Y580T2SS/W509RXS
	125	32		M12 P1.75	25.0	39.0	161.0	100	Y580T4SS/W509RXS
	125	32		M16 P2.0	25.0	39.0	161.0	100	Y580T5SS/W509RXS





TB Total locking brake
 Total Lock system simultaneously locks both swivel head and wheel for a secure parking.
 Zinc-alloy brake pedal.

T Threaded Stem Fitting with Hex Base Washer



PM-SS Wheel Solid nylon wheel, stainless steel roller bearing, stainless steel threadguards

Brake type	mm	mm		mm	mm	mm	mm	kg	Code
Non-brake Free swivel	75	32		1/2-13UNC	1"	33.0	107.0	50	Y381T2SS/W309RXS
	75	32		M12 P1.75	25.0	33.0	107.0	50	Y381T4SS/W309RXS
	75	32		M16 P2.0	25.0	33.0	107.0	50	Y381T5SS/W309RXS
	100	32		1/2-13UNC	1"	40.5	135.0	80	Y481T2SS/W409RXS
	100	32		M12 P1.75	25.0	40.5	135.0	80	Y481T4SS/W409RXS
	100	32		M16 P2.0	25.0	40.5	135.0	80	Y481T5SS/W409RXS
	125	32		1/2-13UNC	1"	39.0	161.0	100	Y581T2SS/W509RXS
	125	32		M12 P1.75	25.0	39.0	161.0	100	Y581T4SS/W509RXS
	125	32		M16 P2.0	25.0	39.0	161.0	100	Y581T5SS/W509RXS



Stainless steel

Pressed stainless steel double ballrace swivel yoke, electrolytic polishing finish



TB/A Total locking brake
Total Lock system locks both swivel head and wheel simultaneously for secure parking. Integrated ON/OFF Nylon brake pedals for easy and quiet operation.



DB/A Directional locking brake
Directional Lock permits free wheel rotation while swivel head remains locked, an easy way to keep equipment traveling straight. Integrated ON/OFF Nylon brake pedals for easy and quiet operation. Release pedal in green color.

H Bolt Hole Fitting

PRB-SS Wheel Plastic hub, grey color elastic rubber tire

Brake type	mm	mm		mm	mm	mm	kg	Code
TB/A Total locking brake	75	32		10.3	33.0	104.5	50	Y380XH1SS/W324S
	75	32		12.3	33.0	104.5	50	Y380XH2SS/W324S
	75	32		12.8	33.0	104.5	50	Y380XH3SS/W324S
	100	32		10.3	40.5	132.5	80	Y480XH1SS/W424DS
	100	32		12.3	40.5	132.5	80	Y480XH2SS/W424DS
	100	32		12.8	40.5	132.5	80	Y480XH3SS/W424DS
	125	32		10.3	39.0	158.5	100	Y580XH1SS/W524DS
	125	32		12.3	39.0	158.5	100	Y580XH2SS/W524DS
	125	32		12.8	39.0	158.5	100	Y580XH3SS/W524DS
TB/B Total locking brake	75	32		10.3	41.0	104.5	50	Y380H1SS/W324S
	75	32		12.3	41.0	104.5	50	Y380H2SS/W324S
	75	32		12.8	41.0	104.5	50	Y380H3SS/W324S
	100	32		10.3	40.5	132.5	80	Y480H1SS/W424DS
	100	32		12.3	40.5	132.5	80	Y480H2SS/W424DS
	100	32		12.8	40.5	132.5	80	Y480H3SS/W424DS
	125	32		10.3	39.0	158.5	100	Y580H1SS/W524DS
	125	32		12.3	39.0	158.5	100	Y580H2SS/W524DS
	125	32		12.8	39.0	158.5	100	Y580H3SS/W524DS
	150	32		10.3	46.5	187.0	100	Y680H1SS/W624DS
	150	32		12.3	46.5	187.0	100	Y680H2SS/W624DS
	150	32		12.8	46.5	187.0	100	Y680H3SS/W624DS























TB Total locking brake
 Total Lock system simultaneously locks both swivel head and wheel for a secure parking.
 Zinc-alloy brake pedal.

H Bolt Hole Fitting

PRB-SS Wheel Plastic hub, grey color elastic rubber tire

Brake type	 mm	 mm		 mm	 mm	 mm	 kg	Code
Non-brake Free swivel	75	32		10.3	33.0	104.5	50	Y381H1SS/W324S
	75	32		12.3	33.0	104.5	50	Y381H2SS/W324S
	75	32		12.8	33.0	104.5	50	Y381H3SS/W324S
	100	32		10.3	40.5	132.5	80	Y481H1SS/W424DS
	100	32		12.3	40.5	132.5	80	Y481H2SS/W424DS
	100	32		12.8	40.5	132.5	80	Y481H3SS/W424DS
	125	32		10.3	39.0	158.5	100	Y581H1SS/W524DS
	125	32		12.3	39.0	158.5	100	Y581H2SS/W524DS
	125	32		12.8	39.0	158.5	100	Y581H3SS/W524DS
	150	32		10.3	50.0	187.0	100	Y681H1SS/W624DS
	150	32		12.3	50.0	187.0	100	Y681H2SS/W624DS
	150	32		12.8	50.0	187.0	100	Y681H3SS/W624DS



 Stainless steel

Pressed stainless steel double ballrace swivel yoke, electrolytic polishing finish





















TB/A Total locking brake
Total Lock system locks both swivel head and wheel simultaneously for secure parking. Integrated ON/OFF Nylon brake pedals for easy and quiet operation.



DB/A Directional locking brake
Directional Lock permits free wheel rotation while swivel head remains locked, an easy way to keep equipment traveling straight. Integrated ON/OFF Nylon brake pedals for easy and quiet operation. Release pedal in green color.

H Bolt Hole Fitting

TPR-SS Wheel Plastic hub, grey color thermoplastic rubber tire

Brake type	 mm	 mm		 mm	 mm	 mm	 kg	Code
TB/A Total locking brake	100	32		10.3	40.5	132.5	80	Y480XH1SS/W403DS
	100	32		12.3	40.5	132.5	80	Y480XH2SS/W403DS
	100	32		12.8	40.5	132.5	80	Y480XH3SS/W403DS
	125	32		10.3	39.0	158.5	100	Y580XH1SS/W503DS
	125	32		12.3	39.0	158.5	100	Y580XH2SS/W503DS
	125	32		12.8	39.0	158.5	100	Y580XH3SS/W503DS
TB/B Total locking brake	100	32		10.3	40.5	132.5	80	Y480H1SS/W403DS
	100	32		12.3	40.5	132.5	80	Y480H2SS/W403DS
	100	32		12.8	40.5	132.5	80	Y480H3SS/W403DS
	125	32		10.3	39.0	158.5	100	Y580H1SS/W503DS
	125	32		12.3	39.0	158.5	100	Y580H2SS/W503DS
	125	32		12.8	39.0	158.5	100	Y580H3SS/W503DS









TB Total locking brake
 Total Lock system simultaneously locks both swivel head and wheel for a secure parking.
 Zinc-alloy brake pedal.

H Bolt Hole Fitting

TPR-SS Wheel Plastic hub, grey color thermoplastic rubber tire

Brake type	mm	mm		mm	mm	mm	kg	Code
Non-brake Free swivel	100	32		10.3	40.5	132.5	80	Y481H1SS/W403DS
	100	32		12.3	40.5	132.5	80	Y481H2SS/W403DS
	100	32		12.8	40.5	132.5	80	Y481H3SS/W403DS
	125	32		10.3	39.0	158.5	100	Y581H1SS/W503DS
	125	32		12.3	39.0	158.5	100	Y581H2SS/W503DS
	125	32		12.8	39.0	158.5	100	Y581H3SS/W503DS



TPR-SS/AS Wheel Conductive wheels are also available

		Code
Plastic hub, grey color conductive thermoplastic rubber tire, stainless steel ball bearings, stainless steel threadguards	100 x 32mm	W403DS-AS
	125 x 32mm	W503DS-AS



Electrical Resistance $\leq 10^4 \Omega$

 Stainless steel

Pressed stainless steel double ballrace swivel yoke, electrolytic polishing finish



TB/A Total locking brake
Total Lock system locks both swivel head and wheel simultaneously for secure parking. Integrated ON/OFF Nylon brake pedals for easy and quiet operation.



DB/A Directional locking brake
Directional Lock permits free wheel rotation while swivel head remains locked, an easy way to keep equipment traveling straight. Integrated ON/OFF Nylon brake pedals for easy and quiet operation. Release pedal in green color.

H Bolt Hole Fitting

TPU-SS Wheel Plastic hub, grey color polyurethane tire

Brake type	mm	mm		mm	mm	mm	kg	Code
TB/A Total locking brake	75	32		10.3	33.0	104.5	50	Y380XH1SS/W300S
	75	32		12.3	33.0	104.5	50	Y380XH2SS/W300S
	75	32		12.8	33.0	104.5	50	Y380XH3SS/W300S
	100	32		10.3	40.5	132.5	80	Y480XH1SS/W400DS
	100	32		12.3	40.5	132.5	80	Y480XH2SS/W400DS
	100	32		12.8	40.5	132.5	80	Y480XH3SS/W400DS
	125	32		10.3	39.0	158.5	100	Y580XH1SS/W500DS
	125	32		12.3	39.0	158.5	100	Y580XH2SS/W500DS
	125	32		12.8	39.0	158.5	100	Y580XH3SS/W500DS
TB/B Total locking brake	75	32		10.3	41.0	104.5	50	Y380H1SS/W300S
	75	32		12.3	41.0	104.5	50	Y380H2SS/W300S
	75	32		12.8	41.0	104.5	50	Y380H3SS/W300S
	100	32		10.3	40.5	132.5	80	Y480H1SS/W400DS
	100	32		12.3	40.5	132.5	80	Y480H2SS/W400DS
	100	32		12.8	40.5	132.5	80	Y480H3SS/W400DS
	125	32		10.3	39.0	158.5	100	Y580H1SS/W500DS
	125	32		12.3	39.0	158.5	100	Y580H2SS/W500DS
	125	32		12.8	39.0	158.5	100	Y580H3SS/W500DS
150	32		10.3	46.5	187.0	100	Y680H1SS/W600DS	
150	32		12.3	46.5	187.0	100	Y680H2SS/W600DS	
150	32		12.8	46.5	187.0	100	Y680H3SS/W600DS	























TB Total locking brake
 Total Lock system simultaneously locks both swivel head and wheel for a secure parking.
 Zinc-alloy brake pedal.

H Bolt Hole Fitting

TPU-SS Wheel Plastic hub, grey color polyurethane tire

Brake type	 mm	 mm		 mm	 mm	 mm	 kg	Code
Non-brake Free swivel	75	32		10.3	33.0	104.5	50	Y381H1SS/W300S
	75	32		12.3	33.0	104.5	50	Y381H2SS/W300S
	75	32		12.8	33.0	104.5	50	Y381H3SS/W300S
	100	32		10.3	40.5	132.5	80	Y481H1SS/W400DS
	100	32		12.3	40.5	132.5	80	Y481H2SS/W400DS
	100	32		12.8	40.5	132.5	80	Y481H3SS/W400DS
	125	32		10.3	39.0	158.5	100	Y581H1SS/W500DS
	125	32		12.3	39.0	158.5	100	Y581H2SS/W500DS
	125	32		12.8	39.0	158.5	100	Y581H3SS/W500DS
	150	32		10.3	50.0	187.0	100	Y681H1SS/W600DS
	150	32		12.3	50.0	187.0	100	Y681H2SS/W600DS
	150	32		12.8	50.0	187.0	100	Y681H3SS/W600DS



 Stainless steel

Pressed stainless steel double ballrace swivel yoke, electrolytic polishing finish



TB/A Total locking brake
Total Lock system locks both swivel head and wheel simultaneously for secure parking. Integrated ON/OFF Nylon brake pedals for easy and quiet operation.



























DB/A Directional locking brake
Directional Lock permits free wheel rotation while swivel head remains locked, an easy way to keep equipment traveling straight. Integrated ON/OFF Nylon brake pedals for easy and quiet operation. Release pedal in green color.

H Bolt Hole Fitting



PM-SS Wheel

Solid nylon wheel, stainless steel roller bearing, stainless steel threadguards

Brake type	 mm	 mm		 mm	 mm	 mm	 kg	Code
TB/A Total locking brake	75	32		10.3	33.0	104.5	50	Y380XH1SS/W309RXS
	75	32		12.3	33.0	104.5	50	Y380XH2SS/W309RXS
	75	32		12.8	33.0	104.5	50	Y380XH3SS/W309RXS
	100	32		10.3	40.5	132.5	80	Y480XH1SS/W409RXS
	100	32		12.3	40.5	132.5	80	Y480XH2SS/W409RXS
	100	32		12.8	40.5	132.5	80	Y480XH3SS/W409RXS
	125	32		10.3	39.0	158.5	100	Y580XH1SS/W509RXS
	125	32		12.3	39.0	158.5	100	Y580XH2SS/W509RXS
	125	32		12.8	39.0	158.5	100	Y580XH3SS/W509RXS
TB/B Total locking brake	75	32		10.3	41.0	104.5	50	Y380H1SS/W309RXS
	75	32		12.3	41.0	104.5	50	Y380H2SS/W309RXS
	75	32		12.8	41.0	104.5	50	Y380H3SS/W309RXS
	100	32		10.3	40.5	132.5	80	Y480H1SS/W409RXS
	100	32		12.3	40.5	132.5	80	Y480H2SS/W409RXS
	100	32		12.8	40.5	132.5	80	Y480H3SS/W409RXS
	125	32		10.3	39.0	158.5	100	Y580H1SS/W509RXS
	125	32		12.3	39.0	158.5	100	Y580H2SS/W509RXS
	125	32		12.8	39.0	158.5	100	Y580H3SS/W509RXS





















TB Total locking brake
 Total Lock system simultaneously locks both swivel head and wheel for a secure parking.
 Zinc-alloy brake pedal.

H Bolt Hole Fitting



PM-SS Wheel Solid nylon wheel, stainless steel roller bearing, stainless steel threadguards

Brake type	 mm	 mm		 mm	 mm	 mm	 kg	Code
Non-brake Free swivel	75	32		10.3	33.0	104.5	50	Y381H1SS/W309RXS
	75	32		12.3	33.0	104.5	50	Y381H2SS/W309RXS
	75	32		12.8	33.0	104.5	50	Y381H3SS/W309RXS
	100	32		10.3	40.5	132.5	80	Y481H1SS/W409RXS
	100	32		12.3	40.5	132.5	80	Y481H2SS/W409RXS
	100	32		12.8	40.5	132.5	80	Y481H3SS/W409RXS
	125	32		10.3	39.0	158.5	100	Y581H1SS/W509RXS
	125	32		12.3	39.0	158.5	100	Y581H2SS/W509RXS
	125	32		12.8	39.0	158.5	100	Y581H3SS/W509RXS



 Stainless steel





SC

Superior Castors

Application:
Stretcher trolleys;
general institution applications.

Size Available:
125x32, 150x32, 200x32mm

The SC is an enduring, sturdy castor, capable to handle fast and jerky movements.

When life dependency of patient is counted on speedy transfer for medical treatment, it requires stretcher trolleys armed with our Superior Castors. Likewise, it is equally important for the comfort of patient while transporting back and forth on stretcher trolley between wards.

Precision ball bearings at the swivel head and wheel axle always make turning and rolling easy. Tight fitting thread guards reduce chances for dirt and lint collected at the axle and slow down wheel rotation.

Undoubtedly, when it comes to efficient, economical, and dependable, this is your castor of choice.

SC SAVES!

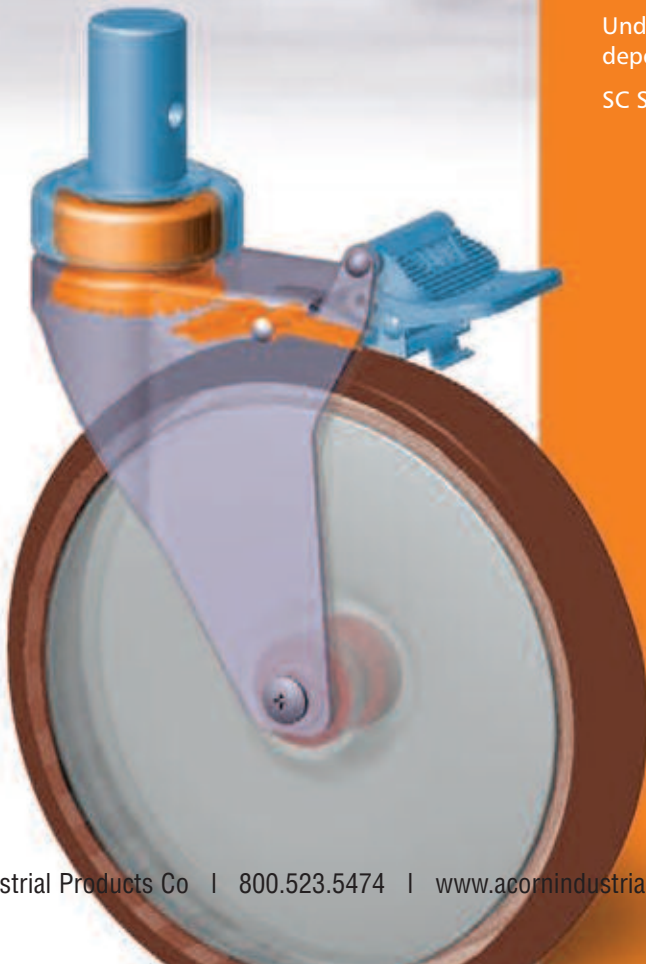

Pressed steel yoke, precision ball bearing swivel head, zinc-chromatized finish

Option: Bright chrome plated finish is also available, add suffix "-CR" to Catis code, e.g. YZ580XP1/W503U-CR



TB Total locking brake

Total Lock system locks both swivel head and wheel simultaneously for secure parking. Integrated ON/OFF Nylon brake pedals for easy and quiet operation.



DB Directional locking brake

Directional Lock permits free wheel rotation while swivel head remains locked, an easy way to keep equipment traveling straight. Integrated ON/OFF Nylon brake pedals for easy and quiet operation. Release pedal in green color.

P Top Plate Fitting



TPR Wheel Plastic hub, grey color thermoplastic rubber tire

Brake type	mm	mm	mm	mm	mm	mm	mm	mm	kg	Code	
TB Total locking brake	125	32		95 x 70	75 x 52 / 72 x 45	9.0	39.0	164.0	100	YZ580XP1/W503U	
	150	32		95 x 70	75 x 52 / 72 x 45	9.0	50.0	192.5	120	YZ680XP1/W603U	
	200	32		95 x 70	75 x 52 / 72 x 45	9.0	57.5	240.0	120	YZ880XP1/W803UX	
DB Dir. locking brake	125	32		95 x 70	75 x 52 / 72 x 45	9.0	39.0	164.0	100	YZ580XDP1/W503U	
	150	32		95 x 70	75 x 52 / 72 x 45	9.0	50.0	192.5	120	YZ680XDP1/W603U	
	200	32		95 x 70	75 x 52 / 72 x 45	9.0	57.5	240.0	120	YZ880XDP1/W803UX	
Non-brake Free swivel	125	32		95 x 70	75 x 52 / 72 x 45	9.0	39.0	164.0	100	YZ581P1/W503U	
	150	32		95 x 70	75 x 52 / 72 x 45	9.0	50.0	192.5	120	YZ681P1/W603U	
	200	32		95 x 70	75 x 52 / 72 x 45	9.0	57.5	240.0	120	YZ881P1/W803UX	
200mm (8") wheel is available with metal threadguards only											



TPR/AS Wheel Conductive wheels are also available















		Code	
Plastic hub and threadguards, grey color conductive thermoplastic rubber tire	125 x 32mm	W503U-AS	
	150 x 32mm	W603U-AS	
	200 x 32mm	W803UX-AS*	

*Wheel with metal threadguards (see P020)

Electrical Resistance $\leq 10^4 \Omega$



















P) Top Plate Fitting

TPU Wheel Plastic hub, grey color polyurethane tire

Brake type										Code
	mm	mm	mm	mm	mm	mm	mm	mm	kg	
TB/A Total locking brake	125	32		95 x 70	75 x 52 / 72 x 45	9.0	39.0	164.0	100	YZ580XP1/W500E
	150	32		95 x 70	75 x 52 / 72 x 45	9.0	50.0	192.5	120	YZ680XP1/W600E
DB/A Dir. locking brake	125	32		95 x 70	75 x 52 / 72 x 45	9.0	39.0	164.0	100	YZ580XDP1/W500E
	150	32		95 x 70	75 x 52 / 72 x 45	9.0	50.0	192.5	120	YZ680XDP1/W600E
Non-brake Free swivel	125	32		95 x 70	75 x 52 / 72 x 45	9.0	39.0	164.0	100	YZ581P1/W500E
	150	32		95 x 70	75 x 52 / 72 x 45	9.0	50.0	192.5	120	YZ681P1/W600E



ARB Wheel Al-alloy hub, grey color high elastic rubber tire

Brake type										Code
	mm	mm	mm	mm	mm	mm	mm	mm	kg	
TB/A Total locking brake	125	32		95 x 70	75 x 52 / 72 x 45	9.0	39.0	164.0	100	YZ580XP1/W529UX
	150	32		95 x 70	75 x 52 / 72 x 45	9.0	50.0	192.5	120	YZ680XP1/W629UX
	200	32		95 x 70	75 x 52 / 72 x 45	9.0	57.5	240.0	120	YZ880XP1/W829UX
DB/A Dir. locking brake	125	32		95 x 70	75 x 52 / 72 x 45	9.0	39.0	164.0	100	YZ580XDP1/W529UX
	150	32		95 x 70	75 x 52 / 72 x 45	9.0	50.0	192.5	120	YZ680XDP1/W629UX
	200	32		95 x 70	75 x 52 / 72 x 45	9.0	57.5	240.0	120	YZ880XDP1/W829UX
Non-brake Free swivel	125	32		95 x 70	75 x 52 / 72 x 45	9.0	39.0	164.0	100	YZ581P1/W529UX
	150	32		95 x 70	75 x 52 / 72 x 45	9.0	50.0	192.5	120	YZ681P1/W629UX
	200	32		95 x 70	75 x 52 / 72 x 45	9.0	57.5	240.0	120	YZ881P1/W829UX



Pressed steel yoke, precision ball bearing swivel head, zinc-chromatized finish

Option: Bright chrome plated finish is also available, add suffix "-CR" to Catis code, e.g. YZ580XP1/W503U-CR



TB Total locking brake

Total Lock system locks both swivel head and wheel simultaneously for secure parking. Integrated ON/OFF Nylon brake pedals for easy and quiet operation.



DB Directional locking brake

Directional Lock permits free wheel rotation while swivel head remains locked, an easy way to keep equipment traveling straight. Integrated ON/OFF Nylon brake pedals for easy and quiet operation. Release pedal in green color.

R Round Stem



TPR Wheel











Plastic hub, grey color thermoplastic rubber tire

Brake type	mm	mm	mm	mm	mm	mm	mm	mm	kg	Code	
TB Total locking brake	125	32		22.0	45.0	19.0	M8x1.25	39.0	164.0	100	YZ580XR8/W503U
	125	32		28.0	45.0	19.0	M8x1.25	39.0	164.0	100	YZ580XR9/W503U
	125	32		25.6	45.0	19.0	M8x1.25	39.0	164.0	100	YZ580XR16/W503U
	150	32		22.0	45.0	19.0	M8x1.25	50.0	192.5	120	YZ680XR8/W603U
	150	32		28.0	45.0	19.0	M8x1.25	50.0	192.5	120	YZ680XR9/W603U
	150	32		25.6	45.0	19.0	M8x1.25	50.0	192.5	120	YZ680XR16/W603U
	200	32		22.0	45.0	19.0	M8x1.25	57.5	240.0	120	YZ880XR8/W803UX
	200	32		28.0	45.0	19.0	M8x1.25	57.5	240.0	120	YZ880XR9/W803UX
200	32		25.6	45.0	19.0	M8x1.25	57.5	240.0	120	YZ880XR16/W803UX	
DB Dir. locking brake	125	32		22.0	45.0	19.0	M8x1.25	39.0	164.0	100	YZ580XDR8/W503U
	125	32		28.0	45.0	19.0	M8x1.25	39.0	164.0	100	YZ580XDR9/W503U
	125	32		25.6	45.0	19.0	M8x1.25	39.0	164.0	100	YZ580XDR16/W503U
	150	32		22.0	45.0	19.0	M8x1.25	50.0	192.5	120	YZ680XDR8/W603U
	150	32		28.0	45.0	19.0	M8x1.25	50.0	192.5	120	YZ680XDR9/W603U
	150	32		25.6	45.0	19.0	M8x1.25	50.0	192.5	120	YZ680XDR16/W603U
	200	32		22.0	45.0	19.0	M8x1.25	57.5	240.0	120	YZ880XDR8/W803UX
	200	32		28.0	45.0	19.0	M8x1.25	57.5	240.0	120	YZ880XDR9/W803UX
200	32		25.6	45.0	19.0	M8x1.25	57.5	240.0	120	YZ880XDR16/W803UX	



R Round Stem

TPR Wheel Plastic hub, grey color thermoplastic rubber tire

Brake type	mm	mm		mm	mm	mm	mm	mm	mm	mm	kg	Code
Non-brake Free swivel	125	32		22.0	45.0	19.0	M8x1.25	39.0	164.0	100	YZ581R8/W503U	
	125	32		28.0	45.0	19.0	M8x1.25	39.0	164.0	100	YZ581R9/W503U	
	125	32		25.6	45.0	19.0	M8x1.25	39.0	164.0	100	YZ581R16/W503U	
	150	32		22.0	45.0	19.0	M8x1.25	50.0	192.5	120	YZ681R8/W603U	
	150	32		28.0	45.0	19.0	M8x1.25	50.0	192.5	120	YZ681R9/W603U	
	150	32		25.6	45.0	19.0	M8x1.25	50.0	192.5	120	YZ681R16/W603U	
	200	32		22.0	45.0	19.0	M8x1.25	57.5	240.0	120	YZ881R8/W803UX	
	200	32		28.0	45.0	19.0	M8x1.25	57.5	240.0	120	YZ881R9/W803UX	
	200	32		25.6	45.0	19.0	M8x1.25	57.5	240.0	120	YZ881R16/W803UX	



200mm (8") wheel is available with metal threadguards only



TPR/AS Wheel Conductive wheels are also available

		Code
Plastic hub and threadguards, grey color conductive thermoplastic rubber tire	125 x 32mm	W503U-AS
	150 x 32mm	W603U-AS
	200 x 32mm	W803UX-AS*



*Wheel with metal threadguards (see P020)

Electrical Resistance $\leq 10^4 \Omega$

Pressed steel yoke, precision ball bearing swivel head, zinc-chromatized finish

Option: Bright chrome plated finish is also available, add suffix "-CR" to Catis code, e.g. YZ580XP1/W503U-CR



TB/A Total locking brake

Total Lock system locks both swivel head and wheel simultaneously for secure parking. Integrated ON/OFF Nylon brake pedals for easy and quiet operation.



DB/A Directional locking brake

Directional Lock permits free wheel rotation while swivel head remains locked, an easy way to keep equipment traveling straight. Integrated ON/OFF Nylon brake pedals for easy and quiet operation. Release pedal in green color.

R Round Stem



TPU Wheel Plastic hub, grey color polyurethane tire

Brake type	mm	mm		mm	mm	mm	mm	mm	mm	kg	Code
TB/A Total locking brake	125	32		22.0	45.0	19.0	M8x1.25	39.0	164.0	100	YZ580XR8/W500E
	125	32		28.0	45.0	19.0	M8x1.25	39.0	164.0	100	YZ580XR9/W500E
	125	32		25.6	45.0	19.0	M8x1.25	39.0	164.0	100	YZ580XR16/W500E
	150	32		22.0	45.0	19.0	M8x1.25	50.0	192.5	120	YZ680XR8/W600E
	150	32		28.0	45.0	19.0	M8x1.25	50.0	192.5	120	YZ680XR9/W600E
	150	32		25.6	45.0	19.0	M8x1.25	50.0	192.5	120	YZ680XR16/W600E
DB/A Dir. locking brake	125	32		22.0	45.0	19.0	M8x1.25	39.0	164.0	100	YZ580XDR8/W500E
	125	32		28.0	45.0	19.0	M8x1.25	39.0	164.0	100	YZ580XDR9/W500E
	125	32		25.6	45.0	19.0	M8x1.25	39.0	164.0	100	YZ580XDR16/W500E
	150	32		22.0	45.0	19.0	M8x1.25	50.0	192.5	120	YZ680XDR8/W600E
	150	32		28.0	45.0	19.0	M8x1.25	50.0	192.5	120	YZ680XDR9/W600E
	150	32		25.6	45.0	19.0	M8x1.25	50.0	192.5	120	YZ680XDR16/W600E
Non-brake Free swivel	125	32		22.0	45.0	19.0	M8x1.25	39.0	164.0	100	YZ581R8/W500E
	125	32		28.0	45.0	19.0	M8x1.25	39.0	164.0	100	YZ581R9/W500E
	125	32		25.6	45.0	19.0	M8x1.25	39.0	164.0	100	YZ581R16/W500E
	150	32		22.0	45.0	19.0	M8x1.25	50.0	192.5	120	YZ681R8/W600E
	150	32		28.0	45.0	19.0	M8x1.25	50.0	192.5	120	YZ681R9/W600E
	150	32		25.6	45.0	19.0	M8x1.25	50.0	192.5	120	YZ681R16/W600E



R Round Stem

ARB Wheel Al-alloy hub, grey color high elastic rubber tire

Brake type	mm	mm		mm	mm	mm	mm	mm	mm	mm	kg	Code
TBA Total locking brake	125	32		22.0	45.0	19.0	M8x1.25	39.0	164.0	100		YZ580XR8/W529UX
	125	32		28.0	45.0	19.0	M8x1.25	39.0	164.0	100		YZ580XR9/W529UX
	125	32		25.6	45.0	19.0	M8x1.25	39.0	164.0	100		YZ580XR16/W529UX
	150	32		22.0	45.0	19.0	M8x1.25	50.0	192.5	120		YZ680XR8/W629UX
	150	32		28.0	45.0	19.0	M8x1.25	50.0	192.5	120		YZ680XR9/W629UX
	150	32		25.6	45.0	19.0	M8x1.25	50.0	192.5	120		YZ680XR16/W629UX
	200	32		22.0	45.0	19.0	M8x1.25	57.5	240.0	120		YZ880XR8/W829UX
	200	32		28.0	45.0	19.0	M8x1.25	57.5	240.0	120		YZ880XR9/W829UX
	200	32		25.6	45.0	19.0	M8x1.25	57.5	240.0	120		YZ880XR16/W829UX
DBA Dir. locking brake	125	32		22.0	45.0	19.0	M8x1.25	39.0	164.0	100		YZ580XDR8/W529UX
	125	32		28.0	45.0	19.0	M8x1.25	39.0	164.0	100		YZ580XDR9/W529UX
	125	32		25.6	45.0	19.0	M8x1.25	39.0	164.0	100		YZ580XDR16/W529UX
	150	32		22.0	45.0	19.0	M8x1.25	50.0	192.5	120		YZ680XDR8/W629UX
	150	32		28.0	45.0	19.0	M8x1.25	50.0	192.5	120		YZ680XDR9/W629UX
	150	32		25.6	45.0	19.0	M8x1.25	50.0	192.5	120		YZ680XDR16/W629UX
	200	32		22.0	45.0	19.0	M8x1.25	57.5	240.0	120		YZ880XDR8/W829UX
	200	32		28.0	45.0	19.0	M8x1.25	57.5	240.0	120		YZ880XDR9/W829UX
	200	32		25.6	45.0	19.0	M8x1.25	57.5	240.0	120		YZ880XDR16/W829UX
Non-brake Free swivel	125	32		22.0	45.0	19.0	M8x1.25	39.0	164.0	100		YZ581R8/W529UX
	125	32		28.0	45.0	19.0	M8x1.25	39.0	164.0	100		YZ581R9/W529UX
	125	32		25.6	45.0	19.0	M8x1.25	39.0	164.0	100		YZ581R16/W529UX
	150	32		22.0	45.0	19.0	M8x1.25	50.0	192.5	120		YZ681R8/W629UX
	150	32		28.0	45.0	19.0	M8x1.25	50.0	192.5	120		YZ681R9/W629UX
	150	32		25.6	45.0	19.0	M8x1.25	50.0	192.5	120		YZ681R16/W629UX
	200	32		22.0	45.0	19.0	M8x1.25	57.5	240.0	120		YZ881R8/W829UX
	200	32		28.0	45.0	19.0	M8x1.25	57.5	240.0	120		YZ881R9/W829UX
	200	32		25.6	45.0	19.0	M8x1.25	57.5	240.0	120		YZ881R16/W829UX



Pressed steel yoke, precision ball bearing swivel head, zinc-chromatized finish

Option: Bright chrome plated finish is also available, add suffix "-CR" to Catis code, e.g. YZ580XP1/W503U-CR



TB Total locking brake

Total Lock system locks both swivel head and wheel simultaneously for secure parking. Integrated ON/OFF Nylon brake pedals for easy and quiet operation.



DB Directional locking brake

Directional Lock permits free wheel rotation while swivel head remains locked, an easy way to keep equipment traveling straight. Integrated ON/OFF Nylon brake pedals for easy and quiet operation. Release pedal in green color.

T Threaded Stem Fitting with Hex Base Washer



TPR Wheel





















Plastic hub, grey color thermoplastic rubber tire

Brake type	mm	mm		mm	mm	mm	kg	Code	
TB Total locking brake	125	32		1/2-13UNC	1_	39.0	164.0	100	YZ580XT2/W503U
	125	32		M12 P1.75	25.0	39.0	164.0	100	YZ580XT4/W503U
	125	32		M16 P2.0	25.0	39.0	164.0	100	YZ580XT5/W503U
	125	32		1/2-20UNF	25.0	39.0	164.0	100	YZ580XT10/W503U
	150	32		1/2-13UNC	1_	50.0	192.5	120	YZ680XT2/W603U
	150	32		M12 P1.75	25.0	50.0	192.5	120	YZ680XT4/W603U
	150	32		M16 P2.0	25.0	50.0	192.5	120	YZ680XT5/W603U
	150	32		1/2-20UNF	25.0	50.0	192.5	120	YZ680XT10/W603U
	200	32		1/2-13UNC	1_	57.5	240.0	120	YZ880XT2/W803UX
	200	32		M12 P1.75	25.0	57.5	240.0	120	YZ880XT4/W803UX
	200	32		M16 P2.0	25.0	57.5	240.0	120	YZ880XT5/W803UX
	200	32		1/2-20UNF	25.0	57.5	240.0	120	YZ880XT10/W803UX



T Threaded Stem Fitting with Hex Base Washer

TPR Wheel Plastic hub, grey color thermoplastic rubber tire

Brake type	 mm	 mm		 mm	 mm	 mm	 mm	 kg	Code
Non-brake Free swivel	125	32		1/2-13UNC	1_	39.0	164.0	100	YZ581T2/W503U
	125	32		M12 P1.75	25.0	39.0	164.0	100	YZ581T4/W503U
	125	32		M16 P2.0	25.0	39.0	164.0	100	YZ581T5/W503U
	125	32		1/2-20UNF	25.0	39.0	164.0	100	YZ581T10/W503U
	150	32		1/2-13UNC	1_	50.0	192.5	120	YZ681T2/W603U
	150	32		M12 P1.75	25.0	50.0	192.5	120	YZ681T4/W603U
	150	32		M16 P2.0	25.0	50.0	192.5	120	YZ681T5/W603U
	150	32		1/2-20UNF	25.0	50.0	192.5	120	YZ681T10/W603U
	200	32		1/2-13UNC	1_	57.5	240.0	120	YZ881T2/W803UX
	200	32		M12 P1.75	25.0	57.5	240.0	120	YZ881T4/W803UX
200	32		M16 P2.0	25.0	57.5	240.0	120	YZ881T5/W803UX	
200	32		1/2-20UNF	25.0	57.5	240.0	120	YZ881T10/W803UX	



200mm (8") wheel is available with metal threadguards only



TPR/AS Wheel Conductive wheels are also available

		Code
Plastic hub and threadguards, grey color conductive thermoplastic rubber tire	125 x 32mm	W503U-AS
	150 x 32mm	W603U-AS
	200 x 32mm	W803UX-AS*



*Wheel with metal threadguards (see P020)

Electrical Resistance $\leq 10^4 \Omega$

Pressed steel yoke, precision ball bearing swivel head, zinc-chromatized finish

Option: Bright chrome plated finish is also available, add suffix "-CR" to Catis code, e.g. YZ580XP1/W503U-CR



TB Total locking brake

Total Lock system locks both swivel head and wheel simultaneously for secure parking. Integrated ON/OFF Nylon brake pedals for easy and quiet operation.



DB Directional locking brake

Directional Lock permits free wheel rotation while swivel head remains locked, an easy way to keep equipment traveling straight. Integrated ON/OFF Nylon brake pedals for easy and quiet operation. Release pedal in green color.

T Threaded Stem Fitting with Hex Base Washer



TPU Wheel Plastic hub, grey color polyurethane tire

Brake type	mm	mm		mm	mm	mm	kg	Code	
TB Total locking brake	125	32		1/2-13UNC	1_	39.0	164.0	100	YZ580XT2/W500E
	125	32		M12 P1.75	25.0	39.0	164.0	100	YZ580XT4/W500E
	125	32		M16 P2.0	25.0	39.0	164.0	100	YZ580XT5/W500E
	125	32		1/2-20UNF	25.0	39.0	164.0	100	YZ580XT10/W500E
	150	32		1/2-13UNC	1_	50.0	192.5	120	YZ680XT2/W600E
	150	32		M12 P1.75	25.0	50.0	192.5	120	YZ680XT4/W600E
	150	32		M16 P2.0	25.0	50.0	192.5	120	YZ680XT5/W600E
	150	32		1/2-20UNF	25.0	50.0	192.5	120	YZ680XT10/W600E
Non-brake Free swivel	125	32		1/2-13UNC	1_	39.0	164.0	100	YZ581T2/W500E
	125	32		M12 P1.75	25.0	39.0	164.0	100	YZ581T4/W500E
	125	32		M16 P2.0	25.0	39.0	164.0	100	YZ581T5/W500E
	125	32		1/2-20UNF	25.0	39.0	164.0	100	YZ581T10/W500E
	150	32		1/2-13UNC	1_	50.0	192.5	120	YZ681T2/W600E
	150	32		M12 P1.75	25.0	50.0	192.5	120	YZ681T4/W600E
	150	32		M16 P2.0	25.0	50.0	192.5	120	YZ681T5/W600E
	150	32		1/2-20UNF	25.0	50.0	192.5	120	YZ681T10/W600E



T Threaded Stem Fitting with Hex Base Washer

ARB Wheel Al-alloy hub, grey color high elastic rubber tire

Brake type	 mm	 mm		 mm	 mm	 mm	 mm	 kg	Code
 Total locking brake	125	32		1/2-13UNC	1_	39.0	164.0	100	YZ580XT2/W529UX
	125	32		M12 P1.75	25.0	39.0	164.0	100	YZ580XT4/W529UX
	125	32		M16 P2.0	25.0	39.0	164.0	100	YZ580XT5/W529UX
	125	32		1/2-20UNF	25.0	39.0	164.0	100	YZ580XT10/W529UX
	150	32		1/2-13UNC	1_	50.0	192.5	120	YZ680XT2/W629UX
	150	32		M12 P1.75	25.0	50.0	192.5	120	YZ680XT4/W629UX
	150	32		M16 P2.0	25.0	50.0	192.5	120	YZ680XT5/W629UX
	150	32		1/2-20UNF	25.0	50.0	192.5	120	YZ680XT10/W629UX
	200	32		1/2-13UNC	1_	57.5	240.0	120	YZ880XT2/W829UX
	200	32		M12 P1.75	25.0	57.5	240.0	120	YZ880XT4/W829UX
	200	32		M16 P2.0	25.0	57.5	240.0	120	YZ880XT5/W829UX
	200	32		1/2-20UNF	25.0	57.5	240.0	120	YZ880XT10/W829UX
Non-brake Free swivel	125	32		1/2-13UNC	1_	39.0	164.0	100	YZ581T2/W529UX
	125	32		M12 P1.75	25.0	39.0	164.0	100	YZ581T4/W529UX
	125	32		M16 P2.0	25.0	39.0	164.0	100	YZ581T5/W529UX
	125	32		1/2-20UNF	25.0	39.0	164.0	100	YZ581T10/W529UX
	150	32		1/2-13UNC	1_	50.0	192.5	120	YZ681T2/W629UX
	150	32		M12 P1.75	25.0	50.0	192.5	120	YZ681T4/W629UX
	150	32		M16 P2.0	25.0	50.0	192.5	120	YZ681T5/W629UX
	150	32		1/2-20UNF	25.0	50.0	192.5	120	YZ681T10/W629UX
	200	32		1/2-13UNC	1_	57.5	240.0	120	YZ881T2/W829UX
	200	32		M12 P1.75	25.0	57.5	240.0	120	YZ881T4/W829UX
	200	32		M16 P2.0	25.0	57.5	240.0	120	YZ881T5/W829UX
	200	32		1/2-20UNF	25.0	57.5	240.0	120	YZ881T10/W829UX



In the business of health care and medical practice, patient comfort is one of the elements considered vital for recovery. The ease with which medical personnel can move medical equipments, and transport patients to and fro is equally important to the wellness of the patients.

Our Central Locking Bed Castors fulfill all criteria prerequisite of first class health care system. Besides easy to install and operate, they are quiet in motion, less machine-like and obtrusive, portraying a more relax atmosphere to the hospital environment.



CL

Central Locking Bed Castors

Application:

Castors for home care and hospital beds.

Size Available:

100x32, 125x32, 150x32, 200x32mm



Pressed steel yoke with precision ball bearing swivel head, zinc-chromatized plating or powder coating finish available



CLB Central locking brake
Various locking functions actuated by means of different cam position, interconnected by hex rod and change lever.

Stem size
Ø 28x98.5, 45°x2

Types available
A Total lock / Free / Dir. lock
B Total lock / Free
C Dir. lock / Free
D Free swivel



TPR Wheel Plastic hub, grey color thermoplastic rubber tire

Brake type	mm	mm		mm	mm	mm	mm	mm	mm	kg	Code
A Total lock / Free / Dir. lock	125	32		28.0	98.5	19.0	M8x1.25	39.0	164.0	100	Y520R99/W503
	125	32		28.0	98.5	19.0	M8x1.25	39.0	164.0	100	Y520R99/W503U
	150	32		28.0	98.5	19.0	M8x1.25	50.0	192.5	120	Y620R99/W603U
	200	32		28.0	98.5	19.0	M8x1.25	57.5	240.0	120	Y820R99/W803UX
B Total lock / Free	125	32		28.0	98.5	19.0	M8x1.25	39.0	164.0	100	Y522R99/W503
	125	32		28.0	98.5	19.0	M8x1.25	39.0	164.0	100	Y522R99/W503U
	150	32		28.0	98.5	19.0	M8x1.25	50.0	192.5	120	Y622R99/W603U
	200	32		28.0	98.5	19.0	M8x1.25	57.5	240.0	120	Y822R99/W803UX
C Dir. lock / Free	125	32		28.0	98.5	19.0	M8x1.25	39.0	164.0	100	Y520DR99/W503
	125	32		28.0	98.5	19.0	M8x1.25	39.0	164.0	100	Y520DR99/W503U
	150	32		28.0	98.5	19.0	M8x1.25	50.0	192.5	120	Y620DR99/W603U
	200	32		28.0	98.5	19.0	M8x1.25	57.5	240.0	120	Y820DR99/W803UX
D Free swivel	125	32		28.0	45.0	19.0	M8x1.25	39.0	164.0	100	Y521R9/W503
	125	32		28.0	45.0	19.0	M8x1.25	39.0	164.0	100	Y521R9/W503U
	150	32		28.0	45.0	19.0	M8x1.25	50.0	192.5	120	Y621R9/W603U
	200	32		28.0	45.0	19.0	M8x1.25	57.5	240.0	120	Y821R9/W803UX



200mm (8") wheel is available with metal threadguards only



TPR/AS Wheel

Conductive wheels are also available

	Code
Plastic hub and threadguards, grey color conductive thermoplastic rubber tire	125 x 32mm W503-AS
	125 x 32mm W503U-AS
	150 x 32mm W603U-AS
	200 x 32mm W803UX-AS*



* Wheel with metal threadguards (see P020)

Electrical Resistance $\leq 10^4 \Omega$



TPU Wheel

Plastic hub, grey color polyurethane tire

Brake type	mm	mm		mm	mm	mm	mm	mm	mm	mm	kg	Code
A Total lock / Free / Dir. lock	125	32		28.0	98.5	19.0	M8x1.25	39.0	164.0	100		Y520R99/W501E
	125	32		28.0	98.5	19.0	M8x1.25	39.0	164.0	100		Y520R99/W501UX*
	150	32		28.0	98.5	19.0	M8x1.25	50.0	192.5	120		Y620R99/W600E
B Total lock / Free	125	32		28.0	98.5	19.0	M8x1.25	39.0	164.0	100		Y522R99/W501E
	125	32		28.0	98.5	19.0	M8x1.25	39.0	164.0	100		Y522R99/W501UX*
	150	32		28.0	98.5	19.0	M8x1.25	50.0	192.5	120		Y622R99/W600E
C Dir. lock / Free	125	32		28.0	98.5	19.0	M8x1.25	39.0	164.0	100		Y520DR99/W501E
	125	32		28.0	98.5	19.0	M8x1.25	39.0	164.0	100		Y520DR99/W501UX*
	150	32		28.0	98.5	19.0	M8x1.25	50.0	192.5	120		Y620DR99/W600E
D Free swivel	125	32		28.0	45.0	19.0	M8x1.25	39.0	164.0	100		Y521R9/W501E
	125	32		28.0	45.0	19.0	M8x1.25	39.0	164.0	100		Y521R9/W501UX*
	150	32		28.0	45.0	19.0	M8x1.25	50.0	192.5	120		Y621R9/W600E



* Wheel with metal threadguards (see P014)

Options:

1. Metal threadguards available to all sizes, add suffix "X" to Catis code, e.g. Y520R99/W503 → Y520R99/W503X
2. Ivory color powder coating finish available to all size with metal threadguards only, add suffix "-IV" to Catis code, e.g. Y520R99/W503X → Y520R99/W503X-IV



Pressed steel yoke with precision ball bearing swivel head; aesthetic ABS cover, zinc-chromatized plating



Central locking brake

Various locking functions actuated by means of different cam position, interconnected by hex rod and change lever.

Stem size

Ø 28x98.5, 45°x2

Types available

- A** Total lock / Free / Dir. lock
- B** Total lock / Free
- C** Dir. lock / Free
- D** Free swivel



TPR Wheel

Plastic hub, grey color thermoplastic rubber tire

Brake type	mm	mm		mm	mm	mm	mm	mm	mm	mm	kg	Code
A Total lock / Free / Dir. lock	125	32		28.0	98.5	19.0	M8x1.25	39.0	164.0	100		DC520R99/W502
	125	32		28.0	98.5	19.0	M8x1.25	39.0	164.0	100		DC520R99/W502U
B Total lock / Free	125	32		28.0	98.5	19.0	M8x1.25	39.0	164.0	100		DC522R99/W502
	125	32		28.0	98.5	19.0	M8x1.25	39.0	164.0	100		DC522R99/W502U
C Dir. lock / Free	125	32		28.0	98.5	19.0	M8x1.25	39.0	164.0	100		DC520DR99/W502
	125	32		28.0	98.5	19.0	M8x1.25	39.0	164.0	100		DC520DR99/W502U
D Free swivel	125	32		28.0	45.0	19.0	M8x1.25	39.0	164.0	100		DC521R9/W502
	125	32		28.0	45.0	19.0	M8x1.25	39.0	164.0	100		DC521R9/W502U



TPR/AS Wheel

Conductive wheels are also available

Add suffix *-AS* to Catis code, e.g. DC520R99/W502-AS

Electrical Resistance < 10⁴ Ω



TPU Wheel Plastic hub, grey color polyurethane tire

Brake type	mm	mm		mm	mm	mm	mm	mm	mm	mm	kg	Code
A	125	32		28.0	98.5	19.0	M8x1.25	39.0	164.0	100		DC520R99/W501
Total lock / Free / Dir. lock	125	32		28.0	98.5	19.0	M8x1.25	39.0	164.0	100		DC520R99/W501U
B	125	32		28.0	98.5	19.0	M8x1.25	39.0	164.0	100		DC522R99/W501
Total lock / Free	125	32		28.0	98.5	19.0	M8x1.25	39.0	164.0	100		DC522R99/W501U
C	125	32		28.0	98.5	19.0	M8x1.25	39.0	164.0	100		DC520DR99/W501
Dir. lock / Free	125	32		28.0	98.5	19.0	M8x1.25	39.0	164.0	100		DC520DR99/W501U
D	125	32		28.0	45.0	19.0	M8x1.25	39.0	164.0	100		DC521R9/W501
Free swivel	125	32		28.0	45.0	19.0	M8x1.25	39.0	164.0	100		DC521R9/W501U



Pressed steel yoke with precision ball bearing swivel head; aesthetic ABS cover, zinc-chromatized plating

Option: Cam position with 30° actuating angle is available (see P148); to order, replace R99 with R66, e.g. Y690R99/W603U → Y690R66/W603U; same for free swivel, replace R9 with R69



CLB Central locking brake
Various locking functions actuated by means of different cam position, interconnected by hex rod and change lever.

Stem size
Ø 28x98.5, 45°x2
Ø 32x50.0, 30°x2

Types available
A Total lock / Free / Dir. lock
B Total lock / Free
C Dir. lock / Free
D Free swivel



TPR Wheel Plastic hub, grey color thermoplastic rubber tire

Brake type	mm	mm	mm	mm	mm	mm	mm	mm	mm	kg	Code
A Total lock / Free / Dir. lock	100	32		28.0	98.5	19.0	M8x1.25	30.0	143.0	80	Y490R99/W403
	125	32		28.0	98.5	19.0	M8x1.25	39.0	165.0	100	Y590R99/W503U
	150	32		28.0	98.5	19.0	M8x1.25	40.0	189.0	120	Y690R99/W603U
	200	32		28.0	98.5	19.0	M8x1.25	52.0	237.0	120	Y890R99/W803U
B Total lock / Free	100	32		28.0	98.5	19.0	M8x1.25	30.0	143.0	80	Y492R99/W403
	125	32		28.0	98.5	19.0	M8x1.25	39.0	165.0	100	Y592R99/W503U
	150	32		28.0	98.5	19.0	M8x1.25	40.0	189.0	120	Y692R99/W603U
	200	32		28.0	98.5	19.0	M8x1.25	52.0	237.0	120	Y892R99/W803U
C Dir. lock / Free	100	32		28.0	98.5	19.0	M8x1.25	30.0	143.0	80	Y490DR99/W403
	125	32		28.0	98.5	19.0	M8x1.25	39.0	165.0	100	Y590DR99/W503U
	150	32		28.0	98.5	19.0	M8x1.25	40.0	189.0	120	Y690DR99/W603U
	200	32		28.0	98.5	19.0	M8x1.25	52.0	237.0	120	Y890DR99/W803U
D Free swivel	100	32		28.0	45.0	19.0	M8x1.25	30.0	143.0	80	Y491R9/W403
	125	32		28.0	45.0	19.0	M8x1.25	39.0	165.0	100	Y591R9/W503U
	150	32		28.0	45.0	19.0	M8x1.25	40.0	189.0	120	Y691R9/W603U
	200	32		28.0	45.0	19.0	M8x1.25	52.0	237.0	120	Y891R9/W803U



TPR/AS Wheel Conductive wheels are also available

Add suffix "-AS" to Catis code, e.g. DC520R99/W502-AS
Electrical Resistance < 10⁴ Ω

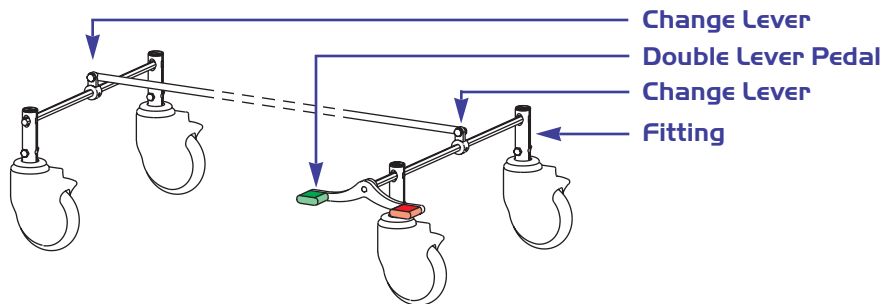

Change Lever

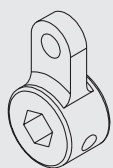

CV28
28mm
Change Lever
to transfer the function
to the second pair
of castors

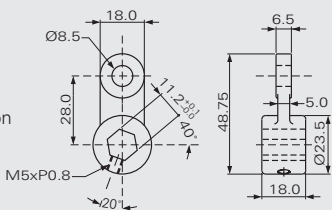

CV65
65mm
Change Lever
to transfer the function
to the second pair
of castors

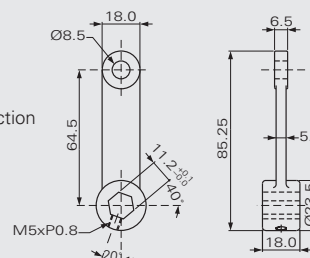

Double Lever Pedal

PD230

Al-Alloy pedal

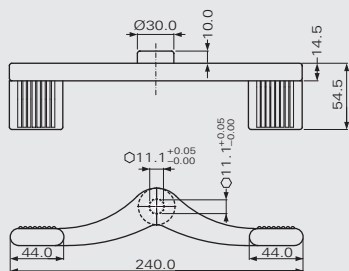

Cam Position



Cam Position

α Actuating angle
R99 2x45°
R66 2x30°

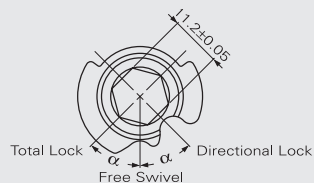

Fitting

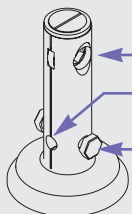

α 2x45°

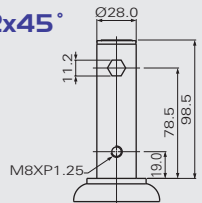

Fitting R99

Stem fitting for 28mm internal
tube diameter.
4xM8 threaded fitting holes at 90°
to each other for easy installation.
Cam hold 90° to direction of travel.

Fitting R9

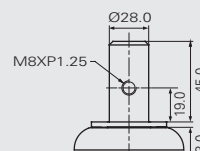

α 2x30°

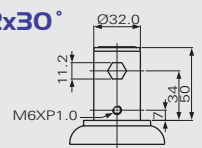

Fitting R66

Stem fitting for 32mm internal
tube diameter.
4xM6 threaded fitting holes at 90°
to each other for easy installation.
Cam hold 90° to direction of travel.

Fitting R69

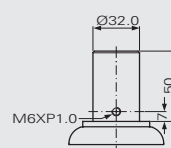

The DC is beautifully designed, and geared towards economical means.

It is especially suitable for general institution applications. And with ABS cover, it can be kept clean easily and adds to the environment a more conspicuous hygienic and aesthetic value.

When carts/trolleys demand quality and a human touch, our DC would be the best choice.



DC

Design Castors

Application:

General institution applications;
medical diagnostic machines.

Size Available:

100x25, 125x32mm

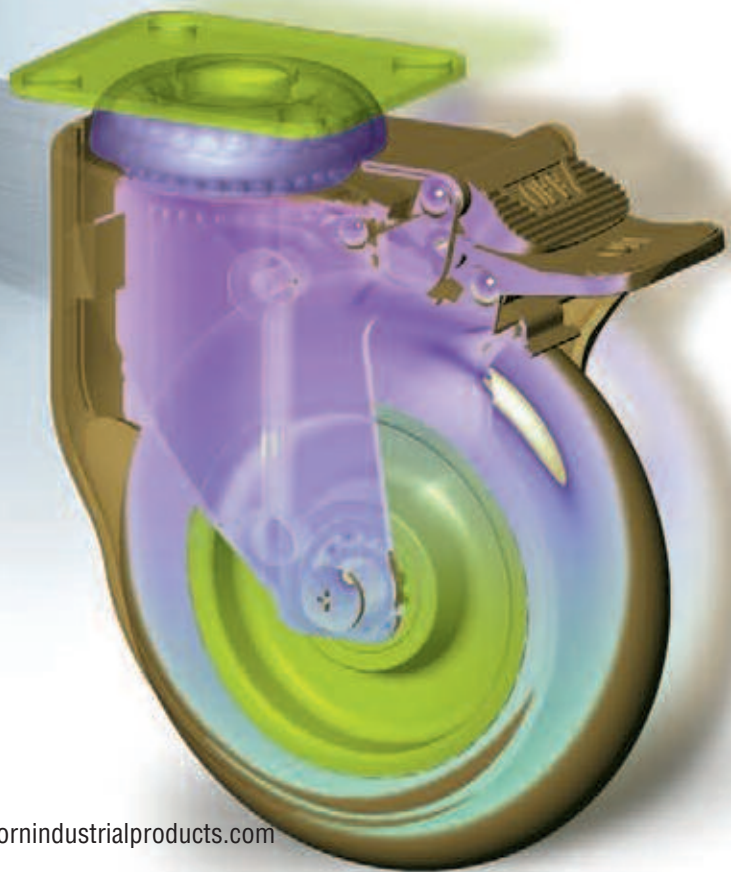

Pressed steel, zinc-chromatized double ballrace swivel yoke, aesthetic streamlined ABS covers



TB/A Total locking brake
Total Lock system locks both swivel head and wheel simultaneously for secure parking. Integrated ON/OFF Nylon brake pedals for easy and quiet operation.



DB/A Directional locking brake
Directional Lock permits free wheel rotation while swivel head remains locked, an easy way to keep equipment traveling straight. Integrated ON/OFF Nylon brake pedals for easy and quiet operation. Release pedal in green color.

P Top Plate Fitting

TPR Wheel Plastic hub, grey color thermoplastic rubber tire

Brake type	mm	mm	mm	mm	mm	mm	mm	mm	kg	Code
TB/A Total locking brake	100	25		95 x 70	75 x 52 / 72 x 45	9.0	38.5	135.0	60	DC100BP1/W412
	100	25		77 x 67	61.5 x 52 / 56 x 45	8.5	38.5	135.0	60	DC100BP2/W412
DB/A Dir. locking brake	125	32		95 x 70	75 x 52 / 72 x 45	9.0	39.0	161.0	100	DC125BP1/W502
	125	32		77 x 67	61.5 x 52 / 56 x 45	8.5	39.0	161.0	100	DC125BP2/W502
	125	32		95 x 70	75 x 52 / 72 x 45	9.0	39.0	161.0	100	DC125BP1/W502U
	125	32		77 x 67	61.5 x 52 / 56 x 45	8.5	39.0	161.0	100	DC125BP2/W502U
Non-brake Free swivel	125	32		95 x 70	75 x 52 / 72 x 45	9.0	39.0	161.0	100	DC125P1/W502
	125	32		77 x 67	61.5 x 52 / 56 x 45	8.5	39.0	161.0	100	DC125P2/W502
	125	32		95 x 70	75 x 52 / 72 x 45	9.0	39.0	161.0	100	DC125P1/W502U
	125	32		77 x 67	61.5 x 52 / 56 x 45	8.5	39.0	161.0	100	DC125P2/W502U

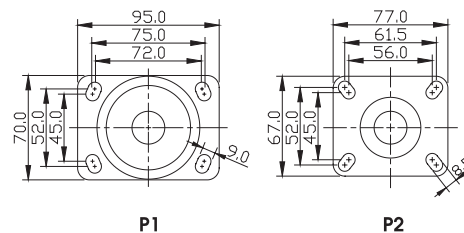

P Top Plate Fitting

TPU Wheel Plastic hub, grey color polyurethane tire

Brake type	mm	mm	mm	mm	mm	mm	mm	mm	kg	Code
TB Total locking brake	125	32		95 x 70	75 x 52 / 72 x 45	9.0	39.0	161.0	100	DC125BP1/W501
	125	32		77 x 67	61.5 x 52 / 56 x 45	8.5	39.0	161.0	100	DC125BP2/W501
	125	32		95 x 70	75 x 52 / 72 x 45	9.0	39.0	161.0	100	DC125BP1/W501U
	125	32		77 x 67	61.5 x 52 / 56 x 45	8.5	39.0	161.0	100	DC125BP2/W501U
DB Dir. locking brake	125	32		95 x 70	75 x 52 / 72 x 45	9.0	39.0	161.0	100	DC125DBP1/W501
	125	32		77 x 67	61.5 x 52 / 56 x 45	8.5	39.0	161.0	100	DC125DBP2/W501
	125	32		95 x 70	75 x 52 / 72 x 45	9.0	39.0	161.0	100	DC125DBP1/W501U
	125	32		77 x 67	61.5 x 52 / 56 x 45	8.5	39.0	161.0	100	DC125DBP2/W501U
Non-brake Free swivel	125	32		95 x 70	75 x 52 / 72 x 45	9.0	39.0	161.0	100	DC125P1/W501
	125	32		77 x 67	61.5 x 52 / 56 x 45	8.5	39.0	161.0	100	DC125P2/W501
	125	32		95 x 70	75 x 52 / 72 x 45	9.0	39.0	161.0	100	DC125P1/W501U
	125	32		77 x 67	61.5 x 52 / 56 x 45	8.5	39.0	161.0	100	DC125P2/W501U



ARB Wheel Al-alloy hub, grey color high elastic rubber tire

Brake type	mm	mm	mm	mm	mm	mm	mm	mm	kg	Code
TB Total locking brake	125	32		95 x 70	75 x 52 / 72 x 45	9.0	39.0	161.0	100	DC125BP1/W529U
	125	32		77 x 67	61.5 x 52 / 56 x 45	8.5	39.0	161.0	100	DC125BP2/W529U
DB Dir. locking brake	125	32		95 x 70	75 x 52 / 72 x 45	9.0	39.0	161.0	100	DC125DBP1/W529U
	125	32		77 x 67	61.5 x 52 / 56 x 45	8.5	39.0	161.0	100	DC125DBP2/W529U
Non-brake Free swivel	125	32		95 x 70	75 x 52 / 72 x 45	9.0	39.0	161.0	100	DC125P1/W529U
	125	32		77 x 67	61.5 x 52 / 56 x 45	8.5	39.0	161.0	100	DC125P2/W529U



Pressed steel, zinc-chromatized double ballrace swivel yoke, aesthetic streamlined ABS covers



TB/A Total locking brake
Total Lock system locks both swivel head and wheel simultaneously for secure parking. Integrated ON/OFF Nylon brake pedals for easy and quiet operation.



DB/A Directional locking brake
Directional Lock permits free wheel rotation while swivel head remains locked, an easy way to keep equipment traveling straight. Integrated ON/OFF Nylon brake pedals for easy and quiet operation. Release pedal in green color.

R Round Stem



















TPR Wheel Plastic hub, grey color thermoplastic rubber tire

Brake type	mm	mm		mm	mm	mm	mm	mm	mm	kg	Code
TB/A Total locking brake	125	32		22.0	45.0	19.0	M8x1.25	39.0	161.0	100	DC125BR8/W502
	125	32		28.0	45.0	19.0	M8x1.25	39.0	161.0	100	DC125BR9/W502
	125	32		25.6	45.0	19.0	M8x1.25	39.0	161.0	100	DC125BR16/W502
	125	32		22.0	45.0	19.0	M8x1.25	39.0	161.0	100	DC125BR8/W502U
	125	32		28.0	45.0	19.0	M8x1.25	39.0	161.0	100	DC125BR9/W502U
	125	32		25.6	45.0	19.0	M8x1.25	39.0	161.0	100	DC125BR16/W502U
DB/A Dir. locking brake	125	32		22.0	45.0	19.0	M8x1.25	39.0	161.0	100	DC125DBR8/W502
	125	32		28.0	45.0	19.0	M8x1.25	39.0	161.0	100	DC125DBR9/W502
	125	32		25.6	45.0	19.0	M8x1.25	39.0	161.0	100	DC125DBR16/W502
	125	32		22.0	45.0	19.0	M8x1.25	39.0	161.0	100	DC125DBR8/W502U
	125	32		28.0	45.0	19.0	M8x1.25	39.0	161.0	100	DC125DBR9/W502U
	125	32		25.6	45.0	19.0	M8x1.25	39.0	161.0	100	DC125DBR16/W502U
Non-brake Free swivel	125	32		22.0	45.0	19.0	M8x1.25	39.0	161.0	100	DC125R8/W502
	125	32		28.0	45.0	19.0	M8x1.25	39.0	161.0	100	DC125R9/W502
	125	32		25.6	45.0	19.0	M8x1.25	39.0	161.0	100	DC125R16/W502
	125	32		22.0	45.0	19.0	M8x1.25	39.0	161.0	100	DC125R8/W502U
	125	32		28.0	45.0	19.0	M8x1.25	39.0	161.0	100	DC125R9/W502U
	125	32		25.6	45.0	19.0	M8x1.25	39.0	161.0	100	DC125R16/W502U



R Round Stem

TPU Wheel Plastic hub, grey color polyurethane tire

Brake type	mm	mm		mm	mm	mm	mm	mm	mm	mm	kg	Code
TB/A Total locking brake	125	32		22.0	45.0	19.0	M8x1.25	39.0	161.0	100	DC125BR8/W501	
	125	32		28.0	45.0	19.0	M8x1.25	39.0	161.0	100	DC125BR9/W501	
	125	32		25.6	45.0	19.0	M8x1.25	39.0	161.0	100	DC125BR16/W501	
	125	32		22.0	45.0	19.0	M8x1.25	39.0	161.0	100	DC125BR8/W501U	
	125	32		28.0	45.0	19.0	M8x1.25	39.0	161.0	100	DC125BR9/W501U	
	125	32		25.6	45.0	19.0	M8x1.25	39.0	161.0	100	DC125BR16/W501U	
DB/A Dir. locking brake	125	32		22.0	45.0	19.0	M8x1.25	39.0	161.0	100	DC125DBR8/W501	
	125	32		28.0	45.0	19.0	M8x1.25	39.0	161.0	100	DC125DBR9/W501	
	125	32		25.6	45.0	19.0	M8x1.25	39.0	161.0	100	DC125DBR16/W501	
	125	32		22.0	45.0	19.0	M8x1.25	39.0	161.0	100	DC125DBR8/W501U	
	125	32		28.0	45.0	19.0	M8x1.25	39.0	161.0	100	DC125DBR9/W501U	
	125	32		25.6	45.0	19.0	M8x1.25	39.0	161.0	100	DC125DBR16/W501U	
Non-brake Free swivel	125	32		22.0	45.0	19.0	M8x1.25	39.0	161.0	100	DC125R8/W501	
	125	32		28.0	45.0	19.0	M8x1.25	39.0	161.0	100	DC125R9/W501	
	125	32		25.6	45.0	19.0	M8x1.25	39.0	161.0	100	DC125R16/W501	
	125	32		22.0	45.0	19.0	M8x1.25	39.0	161.0	100	DC125R8/W501U	
	125	32		28.0	45.0	19.0	M8x1.25	39.0	161.0	100	DC125R9/W501U	
	125	32		25.6	45.0	19.0	M8x1.25	39.0	161.0	100	DC125R16/W501U	



Pressed steel, zinc-chromatized double ballrace swivel yoke, aesthetic streamlined ABS covers



TB/A Total locking brake

Total Lock system locks both swivel head and wheel simultaneously for secure parking. Integrated ON/OFF Nylon brake pedals for easy and quiet operation.



DB/A Directional locking brake

Directional Lock permits free wheel rotation while swivel head remains locked, an easy way to keep equipment traveling straight. Integrated ON/OFF Nylon brake pedals for easy and quiet operation. Release pedal in green color.

R Round Stem





















ARB Wheel Al-alloy hub, grey color high elastic rubber tire

Brake type	mm	mm		mm	mm	mm	mm	mm	mm	kg	Code
TB/A Total locking brake	125	32		22.0	45.0	19.0	M8x1.25	39.0	161.0	100	DC125BR8/W529U
	125	32		28.0	45.0	19.0	M8x1.25	39.0	161.0	100	DC125BR9/W529U
	125	32		25.6	45.0	19.0	M8x1.25	39.0	161.0	100	DC125BR16/W529U
DB/A Dir. locking brake	125	32		22.0	45.0	19.0	M8x1.25	39.0	161.0	100	DC125DBR8/W529U
	125	32		28.0	45.0	19.0	M8x1.25	39.0	161.0	100	DC125DBR9/W529U
	125	32		25.6	45.0	19.0	M8x1.25	39.0	161.0	100	DC125DBR16/W529U
Non-brake Free swivel	125	32		22.0	45.0	19.0	M8x1.25	39.0	161.0	100	DC125R8/W529U
	125	32		28.0	45.0	19.0	M8x1.25	39.0	161.0	100	DC125R9/W529U
	125	32		25.6	45.0	19.0	M8x1.25	39.0	161.0	100	DC125R16/W529U



T Threaded Stem Fitting with Hex Base Washer

TPR Wheel Plastic hub, grey color thermoplastic rubber tire

Brake type	mm	mm		mm	mm	mm	mm	kg	Code
TB/A Total locking brake	100	25		1/2-13UNC	1"	38.5	135.0	60	DC100BT2/W412
	100	25		M12 P1.75	25.0	38.5	135.0	60	DC100BT4/W412
	100	25		M16 P2.0	25.0	38.5	135.0	60	DC100BT5/W412
	100	25		1/2-20UNF	25.0	38.5	135.0	60	DC100BT10/W412
	125	32		1/2-13UNC	1"	39.0	161.0	100	DC125BT2/W502
	125	32		M12 P1.75	25.0	39.0	161.0	100	DC125BT4/W502
	125	32		M16 P2.0	25.0	39.0	161.0	100	DC125BT5/W502
	125	32		1/2-20UNF	25.0	39.0	161.0	100	DC125BT10/W502
	125	32		1/2-13UNC	1"	39.0	161.0	100	DC125BT2/W502U
	125	32		M12 P1.75	25.0	39.0	161.0	100	DC125BT4/W502U
	125	32		M16 P2.0	25.0	39.0	161.0	100	DC125BT5/W502U
	125	32		1/2-20UNF	25.0	39.0	161.0	100	DC125BT10/W502U
Non-brake Free swivel	125	32		1/2-13UNC	1"	39.0	161.0	100	DC125T2/W502
	125	32		M12 P1.75	25.0	39.0	161.0	100	DC125T4/W502
	125	32		M16 P2.0	25.0	39.0	161.0	100	DC125T5/W502
	125	32		1/2-20UNF	25.0	39.0	161.0	100	DC125T10/W502
	125	32		1/2-13UNC	1"	39.0	161.0	100	DC125T2/W502U
	125	32		M12 P1.75	25.0	39.0	161.0	100	DC125T4/W502U
	125	32		M16 P2.0	25.0	39.0	161.0	100	DC125T5/W502U
	125	32		1/2-20UNF	25.0	39.0	161.0	100	DC125T10/W502U



Pressed steel, zinc-chromatized double ballrace swivel yoke, aesthetic streamlined ABS covers













TB/A Total locking brake
Total Lock system locks both swivel head and wheel simultaneously for secure parking. Integrated ON/OFF Nylon brake pedals for easy and quiet operation.



DB/A Directional locking brake
Directional Lock permits free wheel rotation while swivel head remains locked, an easy way to keep equipment traveling straight. Integrated ON/OFF Nylon brake pedals for easy and quiet operation. Release pedal in green color.

T Threaded Stem Fitting with Hex Base Washer









TPU Wheel Plastic hub, grey color polyurethane tire

Brake type	 mm	 mm		 mm	 mm	 mm	 mm	 kg	Code
TB/A Total locking brake	125	32		1/2-13UNC	1"	39.0	161.0	100	DC125BT2/W501
	125	32		M12 P1.75	25.0	39.0	161.0	100	DC125BT4/W501
	125	32		M16 P2.0	25.0	39.0	161.0	100	DC125BT5/W501
	125	32		1/2-20UNF	25.0	39.0	161.0	100	DC125BT10/W501
	125	32		1/2-13UNC	1"	39.0	161.0	100	DC125BT2/W501U
	125	32		M12 P1.75	25.0	39.0	161.0	100	DC125BT4/W501U
	125	32		M16 P2.0	25.0	39.0	161.0	100	DC125BT5/W501U
	125	32		1/2-20UNF	25.0	39.0	161.0	100	DC125BT10/W501U
Non-brake Free swivel	125	32		1/2-13UNC	1"	39.0	161.0	100	DC125T2/W501
	125	32		M12 P1.75	25.0	39.0	161.0	100	DC125T4/W501
	125	32		M16 P2.0	25.0	39.0	161.0	100	DC125T5/W501
	125	32		1/2-20UNF	25.0	39.0	161.0	100	DC125T10/W501
	125	32		1/2-13UNC	1"	39.0	161.0	100	DC125T2/W501U
	125	32		M12 P1.75	25.0	39.0	161.0	100	DC125T4/W501U
	125	32		M16 P2.0	25.0	39.0	161.0	100	DC125T5/W501U
	125	32		1/2-20UNF	25.0	39.0	161.0	100	DC125T10/W501U



T Threaded Stem Fitting with Hex Base Washer

ARB Wheel Al-alloy hub, grey color high elastic rubber tire

Brake type	 mm	 mm		 mm	 mm	 mm	 mm	 kg	Code
TB Total locking brake	125	32		1/2-13UNC	1"	39.0	161.0	100	DC125BT2/W529U
	125	32		M12 P1.75	25.0	39.0	161.0	100	DC125BT4/W529U
	125	32		M16 P2.0	25.0	39.0	161.0	100	DC125BT5/W529U
	125	32		1/2-20UNF	25.0	39.0	161.0	100	DC125BT10/W529U
Non-brake Free swivel	125	32		1/2-13UNC	1"	39.0	161.0	100	DC125T2/W529U
	125	32		M12 P1.75	25.0	39.0	161.0	100	DC125T4/W529U
	125	32		M16 P2.0	25.0	39.0	161.0	100	DC125T5/W529U
	125	32		1/2-20UNF	25.0	39.0	161.0	100	DC125T10/W529U





BB-TEK

Bi-brake Castors

Our patented BB-Tek is a star creation of Catis and a pride of Taiwan.

Incorporated into the same castor are two locking functions unseen in the trade, that is Total Locking and Directional Locking combined in one unit. Its simplicity in use and reliability is unmatched by any castor made, and has been most favored by medical appliances manufacturers and high-tech industry in the world.

With a slight touch of pedal, you can lock the swivel head and moves straight ahead. Likewise, you can choose to unlock the wheel for lateral movement, or another tap to have the equipment firmly parked.

All carried out at the tip of the toe.

Application:

Medical diagnostic machines;
hi-tech apparatus.

Size Available:

125x32, 150x40, 200x40mm

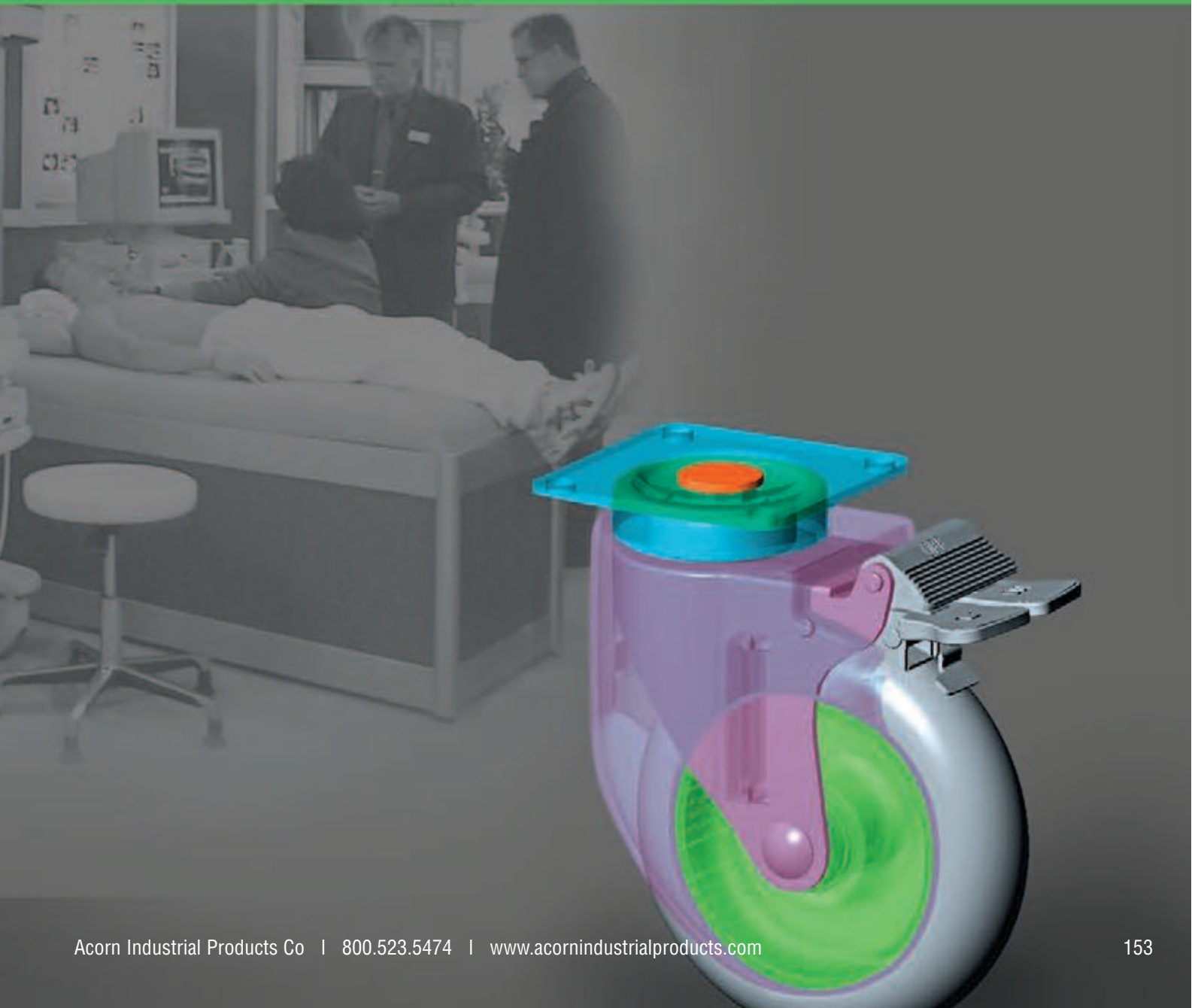

Pressed steel, zinc-chromatized swivel yoke, precision ball bearing at axle, aesthetic ABS covers; for 125mm wheel, double ballrace swivel head; for 150mm and 200mm wheels, precision ball bearing at swivel head; patented bi-brake design provides total locking and directional locking in one system



BB Two In One Bi-Brake System

Two locking functions, Directional and Total Lock incorporated into a single castor. When straight-line tracking is required, simply engage the Directional Lock (green pedal); switching to safe parking is equally easy with a single tap of the Total Lock (red pedal). Unleash all locks for lateral movement and easy maneuvering in tight space and turning corners.

P Top Plate Fitting

TPR Wheel Plastic hub, grey color thermoplastic rubber tire

Brake type	mm	mm	mm	mm	mm	mm	mm	mm	kg	Code
BB Bi-Brake	125	32		95 x 70	75 x 52 / 72 x 45	9.0	39.0	161.0	100	TS125BP1/W502U
	125	32		77 x 67	61.5 x 52 / 56 x 45	8.5	39.0	161.0	100	TS125BP2/W502U
	150	40		114.3 x 101.6	93 x 67	9.0	46.0	196.5	150	TS150BP6/W630U
	150	40		100 x 100	80 x 80	10.0	46.0	196.5	150	TS150BP8/W630U

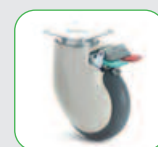

ARB Wheel Al-alloy hub, grey color high elastic rubber tire

Brake type	mm	mm	mm	mm	mm	mm	mm	mm	kg	Code
BB Bi-Brake	125	32		95 x 70	75 x 52 / 72 x 45	9.0	39.0	161.0	100	TS125BP1/W529U
	125	32		77 x 67	61.5 x 52 / 56 x 45	8.5	39.0	161.0	100	TS125BP2/W529U
	150	40		114.3 x 101.6	93 x 67	9.0	46.0	196.5	150	TS150BP6/W640U
	150	40		100 x 100	80 x 80	10.0	46.0	196.5	150	TS150BP8/W640U
	200	40		114.3 x 101.6	93 x 67	9.0	49.0	250.0	150	TS200BP6/W840U
	200	40		100 x 100	80 x 80	10.0	49.0	250.0	150	TS200BP8/W840U

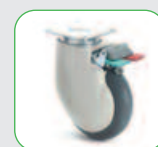











Brake type	mm	mm	mm	mm	mm	mm	mm	kg	Code
Non-brake Fixed	200	40		114.3 x 101.6	93 x 67	9.0	250.0	150	TS203P6/W840U



P Top Plate Fitting

TPU Wheel Plastic hub, grey color polyurethane tire

Brake type	 mm	 mm	 mm	 mm	 mm	 mm	 mm	 mm	 mm	kg	Code
BB	125	32		95 x 70	75 x 52 / 72 x 45	9.0	39.0	161.0	100		TS125BP1/W501U
Bi-Brake	125	32		77 x 67	61.5 x 52 / 56 x 45	8.5	39.0	161.0	100		TS125BP2/W501U

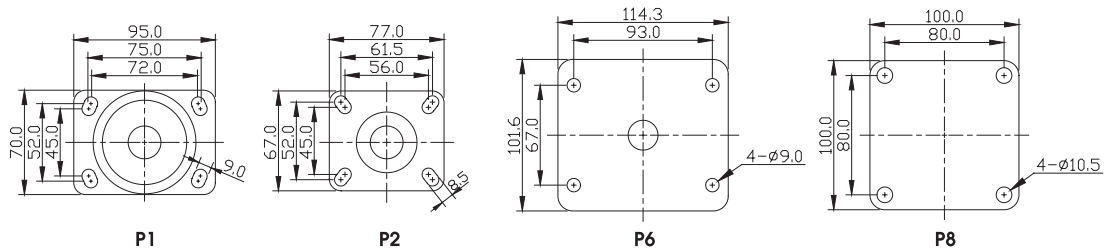

Pressed steel, zinc-chromatized swivel yoke, precision ball bearing at axle, aesthetic ABS covers; for 125mm wheel, double ballrace swivel head; for 150mm and 200mm wheels, precision ball bearing at swivel head; patented bi-brake design provides total locking and directional locking in one system



BB/ Two In One Bi-Brake System

Two locking functions, Directional and Total Lock incorporated into a single castor. When straight-line tracking is required, simply engage the Directional Lock (green pedal); switching to safe parking is equally easy with a single tap of the Total Lock (red pedal). Unleash all locks for lateral movement and easy maneuvering in tight space and turning corners.

R Round Stem

TPR Wheel Plastic hub, grey color thermoplastic rubber tire

Brake type	mm	mm		mm	mm	mm	mm	mm	mm	mm	kg	Code
BB/ Bi-Brake	125	32		22.0	45.0	19.0	M8x1.25	39.0	161.0	100		TS125BR8/W502U
	125	32		28.0	45.0	19.0	M8x1.25	39.0	161.0	100		TS125BR9/W502U
	125	32		25.6	45.0	19.0	M8x1.25	39.0	161.0	100		TS125BR16/W502U
	150	40		22.0	45.0	19.0	M8x1.25	46.0	196.5	150		TS150BR8/W630U
	150	40		28.0	45.0	19.0	M8x1.25	46.0	196.5	150		TS150BR9/W630U
	150	40		25.6	45.0	19.0	M8x1.25	46.0	196.5	150		TS150BR16/W630U



ARB Wheel Al-alloy hub, grey color high elastic hubber tire





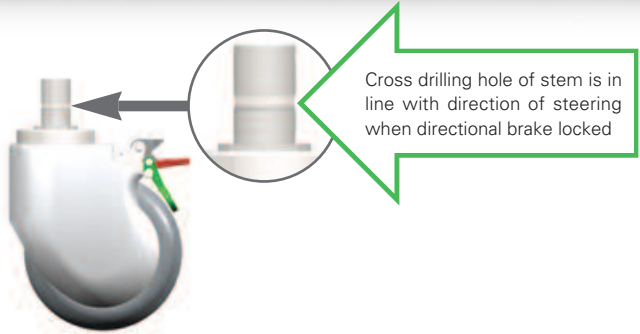











Brake type	mm	mm		mm	mm	mm	mm	mm	mm	mm	kg	Code
BB/ Bi-Brake	125	32		22.0	45.0	19.0	M8x1.25	39.0	161.0	100		TS125BR8/W529U
	125	32		28.0	45.0	19.0	M8x1.25	39.0	161.0	100		TS125BR9/W529U
	125	32		25.6	45.0	19.0	M8x1.25	39.0	161.0	100		TS125BR16/W529U
	150	40		22.0	45.0	19.0	M8x1.25	46.0	196.5	150		TS150BR8/W640U
	150	40		28.0	45.0	19.0	M8x1.25	46.0	196.5	150		TS150BR9/W640U
	150	40		25.6	45.0	19.0	M8x1.25	46.0	196.5	150		TS150BR16/W640U
	200	40		22.0	45.0	19.0	M8x1.25	49.0	250.0	150		TS200BR8/W840U
	200	40		28.0	45.0	19.0	M8x1.25	49.0	250.0	150		TS200BR9/W840U
	200	40		25.6	45.0	19.0	M8x1.25	49.0	250.0	150		TS200BR16/W840U





R Round Stem

TPU Wheel Plastic hub, grey color polyurethane tire

Brake type	 mm	 mm		 mm	 mm	 mm	 mm	 mm	 mm	 mm	 mm	 mm	 mm	kg	Code
BB Bi-Brake	125	32		22.0	45.0	19.0	M8x1.25	39.0	161.0	100					TS125BR8/W501U
	125	32		28.0	45.0	19.0	M8x1.25	39.0	161.0	100					TS125BR9/W501U
	125	32		25.6	45.0	19.0	M8x1.25	39.0	161.0	100					TS125BR16/W501U



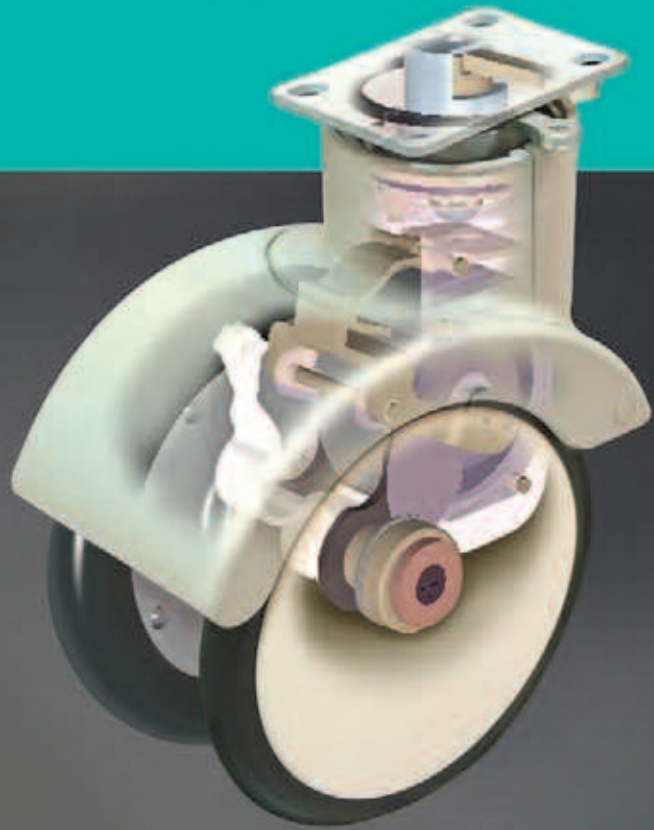

FUTURA

Suspension Castors

U.S. Patent US 6,823,560 B2

Our Futura adds another dimension to the meaning of Performance Art. Its patented suspension and braking design is a total revolution in castor industry.

Secluded behind the dynamic casing, is the heart and soul of this innovation: locking and suspension components, all protected within a single piece of steel housing. Braking is acted on the internal surface of the wheel leaving no dent on the tread and markedly reduces the chance for tire damage. All intended to provide your valuable and sensitive equipment with the protection and convenience it needs.

Since the advent of the Futura, major manufacturers in medical diagnostic equipments dare to restructure and upgrade their products, realizing that Futura could move their prized equipments around, without the nagging concern of system breakdown due to vibrations during motion. If your products deserve a TLC mover, this is it!

At Catis, we always look for better solutions.

Applications:

High-end medical diagnostic ultrasound machines; sensitive electronic equipments.

Size available:

150 mm

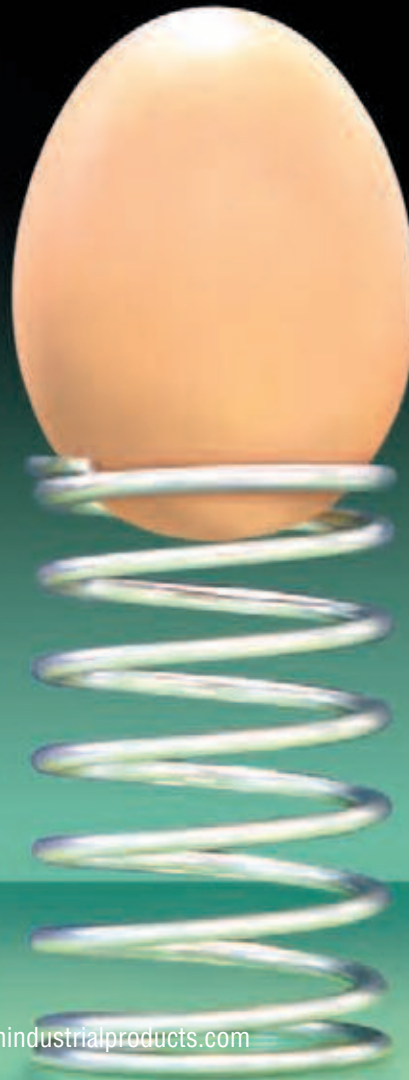





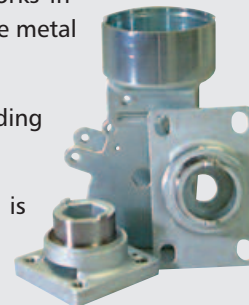

FEATURES

- ABS mud guard, designed to rise and fall with wheel motion, allowing maximum clearance at mounting interface. It is easy to maintain, preventing cable and wire caught in between wheels, and keeps wheels from collecting food spill and dirt. Would not decolorize because color pigment is included in injection process.
- Innovated dual brake design that operates from the inside of the wheel. As braking acts on the internal surface of the wheel, it eliminates abrasion on tread surface, which often leads to wheel damage.
- Precision ball bearings at swivel head and wheel axle warrant quiet transport, and minimize starting and swivel resistance.
- Rubber formulated separately for the twin wheels and patented suspension core works in synergy to provide easy maneuvering, and maximum shock dampening function. Unlike metal spring, rebound is smooth and quiet.
- Exceptional structural strength as yoke, and top plate are mold cast, without any welding weak spot. Zinc plating finish provides long lasting protection.
- Each castor is designed to carry 100kgs (220lbs), but a total load of 300kgs (660lbs) is recommended for the vehicles using 4 castors, as frequently, only 3 castors are in contact with ground surface.















OPTIONS









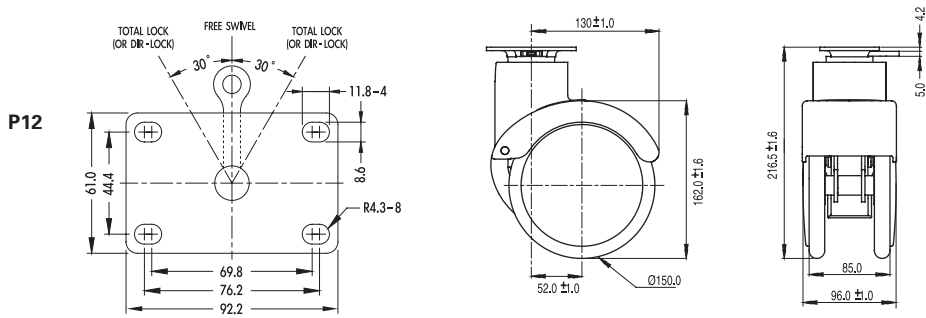



4 standard colors: Grey  Ivory  Green  and Blue 

4 standard operating modes: Free swivel; (round stem fitting is available to this mode only)
 Directional lock / Free swivel
 Total lock / Free swivel
 Total lock / Free swivel / Directional lock

Color, covers and mounting configuration can be customized to match your equipment (see Custom Made P189).

Brake type											Code
Total lock	150	16x2		Rubber	P12	52	130	216.5	100	70±5 A	SU150BP12/RB
Dir. lock	150	16x2		Rubber	P12	52	130	216.5	100	70±5 A	SU150BP12/RB
Non-brake Free swivel	150	16x2		Rubber	P12	52	130	216.5	100	70±5 A	SU150P12/RB



Brake type											Code
Free swivel Total lock	150	16x2		Rubber	P13	52	130	226.1	100	70±5 A	SU150BBP13/RB
Dir. lock	150	16x2		Rubber	P13	52	130	226.1	100	70±5 A	SU150P13/RB
Non-brake Free swivel	150	16x2		Rubber	P13	52	130	226.1	100	70±5 A	SU150P13/RB

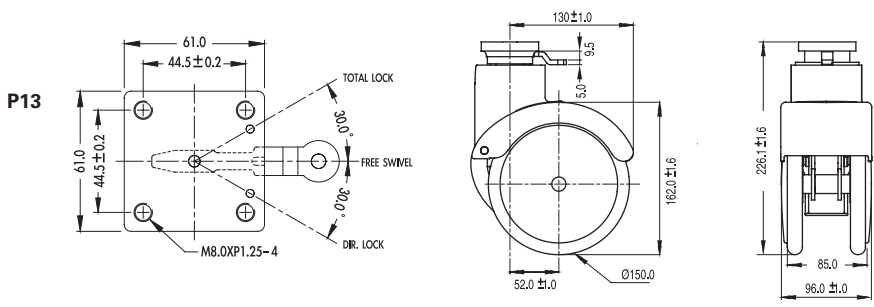



TW

Twin Wheel Castors

The twin wheel design provides wider traction surface and stability for the mobile units. While it is widely used with catering trolleys in order to reduce annoying food spillage, hoist and lifts used for patients transfer in health care business found it equally indispensable.

Application:

Catering trolleys; patients transfer carts.

Size Available:

75x25mmx2, 100x25mmx2



Pressed steel, zinc-chromatized double ball race swivel yoke, twin wheels design

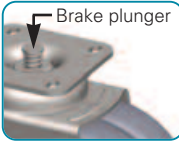

TWB Wheel locking brake

Widely used for mobile units equipped with a centralized lock linkage system. Wheel braking / release is activated by means of a brake plunger which is in turn controlled by the linkage system.

P Top Plate Fitting

TPR Wheel Plastic hub, grey color thermoplastic rubber tire

Brake type	mm	mm	mm	mm	mm	mm	mm	mm	kg	Code
TWB Wheel locking brake	075x2	25x2		70 x 55	56.5 x 41 / 50.5 x 41	5.5	31.4	103.0	100	TW75BP4/W312N
	100x2	25x2		70 x 55	56.5 x 41 / 50.5 x 41	5.5	37.0	126.5	100	TW100BP4/W412N
Non-brake Free swivel	075x2	25x2		77 x 67	61.5 x 52 / 56.0 x 45	8.5	31.4	103.0	100	TW75P2/W312N
	075x2	25x2		70 x 55	56.5 x 41 / 50.5 x 41	5.5	31.4	103.0	100	TW75P4/W312N
	100x2	25x2		77 x 67	61.5 x 52 / 56.0 x 45	8.5	37.0	126.5	100	TW100P2/W412N
	100x2	25x2		70 x 55	56.5 x 41 / 50.5 x 41	5.5	37.0	126.5	100	TW100P4/W412N



TPU Wheel Plastic hub, grey color polyurethane tire

Brake type	mm	mm	mm	mm	mm	mm	mm	mm	kg	Code
TWB Wheel locking brake	075x2	25x2		70 x 55	56.5 x 41 / 50.5 x 41	5.5	31.4	103.0	100	TW75BP4/W315CX
	100x2	25x2		70 x 55	56.5 x 41 / 50.5 x 41	5.5	37.0	126.5	100	TW100BP4/W415CX
Non-brake Free swivel	075x2	25x2		77 x 67	61.5 x 52 / 56.0 x 45	8.5	31.4	103.0	100	TW75P2/W315CX
	075x2	25x2		70 x 55	56.5 x 41 / 50.5 x 41	5.5	31.4	103.0	100	TW75P4/W315CX
	100x2	25x2		77 x 67	61.5 x 52 / 56.0 x 45	8.5	37.0	126.5	100	TW100P2/W415CX
	100x2	25x2		70 x 55	56.5 x 41 / 50.5 x 41	5.5	37.0	126.5	100	TW100P4/W415CX

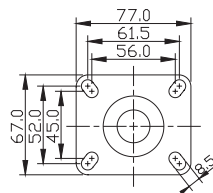

P2

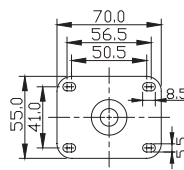

P4

Option: Stainless Steel Twin Wheels Castors

Pressed stainless steel double ballrace swivel yoke, electrolytic polishing finish, thermoplastic rubber wheel with stainless steel precision ball bearing (AISI440C) and threadguards, all metal parts in stainless steel material

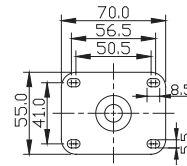

P4

P Top Plate Fitting

TPR-SS Wheel Plastic hub, grey color thermoplastic rubber tire

Brake type	mm	mm	mm	mm	mm	mm	mm	kg	Code	
TWB	075x2	25x2		70 x 55	56.5 x 41 / 50.5 x 41	5.5	31.4	103.0	100	TW75BP4SS/W312NS
Wheel locking brake	100x2	25x2		70 x 55	56.5 x 41 / 50.5 x 41	5.5	37.0	126.5	100	TW100BP4SS/W412NS
Non-brake Free swivel	075x2	25x2		70 x 55	56.5 x 41 / 50.5 x 41	5.5	31.4	103.0	100	TW75P4SS/W312NS
	100x2	25x2		70 x 55	56.5 x 41 / 50.5 x 41	5.5	37.0	126.5	100	TW100P4SS/W412NS



T Threaded Stem Fitting with Hex Base Washer

TPR-SS Wheel Plastic hub, grey color thermoplastic rubber tire

Brake type	mm	mm	mm	mm	mm	mm	mm	kg	Code
Non-brake Free swivel	075x2	25x2		1/2-13UNC	1	31.4	103.0	100	TW75T2SS/W312NS
	075x2	25x2		M12 P1.75	25.0	31.4	103.0	100	TW75T4SS/W312NS
	100x2	25x2		1/2-13UNC	1	37.0	126.5	100	TW100T2SS/W412NS
	100x2	25x2		M12 P1.75	25.0	37.0	126.5	100	TW100T4SS/W412NS



H Bolt Hole Fitting

TPR-SS Wheel Plastic hub, grey color thermoplastic rubber tire

Brake type	mm	mm	mm	mm	mm	mm	kg	Code
Non-brake Free swivel	075x2	25x2		10.3	31.4	100.0	100	TW75H1SS/W312NS
	075x2	25x2		12.3	31.4	100.0	100	TW75H2SS/W312NS
	075x2	25x2		12.8	31.4	100.0	100	TW75H3SS/W312NS
	100x2	25x2		10.3	37.0	123.5	100	TW100H1SS/W412NS
	100x2	25x2		12.3	37.0	123.5	100	TW100H2SS/W412NS
	100x2	25x2		12.8	37.0	123.5	100	TW100H3SS/W412NS



A highly stylized engineering plastic castor whose sturdiness comes from fiberglass reinforced plastic body. Firm and easy steering is a result of precision ball bearing being embedded into the swivel head during injection process, a procedure that secure the bearing and adding extra strength to the yoke at the same time. Total water proofing can be achieved by using stainless steel metal components and washable lubricant.

While stainless steel castor is the best choice to use around moisture prone areas, it is often less desirable for its obtrusive metallic effect, especially used with health care equipments. When conditions demand for a human touch and subtleness, our plastic PT castor would be the best choice without debate.



PT

Polytech Castors

Application:

Rehabilitating trolleys/carts; medical cabinets;
food carts; infant carriages; business machines.

Size Available:

100x25, 125x32mm



Nylon 6 with fiber-glass reinforced body, precision ball bearing swivel head, thermoplastic rubber wheel with ball bearings



TB/c Total locking brake
Total Lock system locks both swivel head and wheel simultaneously for a secure parking. Grey color Nylon brake pedal. Available for PolyTech series only.



DB/c Directional locking brake
Directional Lock permits free wheel rotation while swivel head remains locked, an easy way to keep equipment traveling straight. Green color Nylon brake pedal. Available for PolyTech series only.

P Top Plate Fitting

TPR Wheel Plastic hub, grey color thermoplastic rubber tire



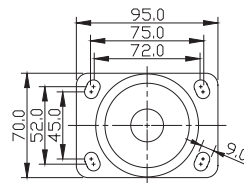



















Brake type	mm	mm		mm	mm	mm	mm	mm	kg	Code
TB/c Total locking brake	100	25		95 x 70	75 x 52 / 72 x 45	9.0	35.0	142.0	60	PT100BP1/W402
	125	32		95 x 70	75 x 52 / 72 x 45	9.0	44.0	166.0	100	PT125BP1/W502
DB/c Dir. locking brake	125	32		95 x 70	75 x 52 / 72 x 45	9.0	44.0	166.0	100	PT125DBP1/W502
Non-brake Free swivel	100	25		95 x 70	75 x 52 / 72 x 45	9.0	35.0	142.0	60	PT100P1/W402
	125	32		95 x 70	75 x 52 / 72 x 45	9.0	44.0	166.0	100	PT125P1/W502



P1

Round Stem

TPR Wheel Plastic hub, grey color thermoplastic rubber tire

Brake type	 mm	 mm		 mm	 mm	 mm	 mm	 mm	 mm	 mm	 mm	kg	Code
 Total locking brake	125	32		22.0	45.0	19.0	M8x1.25	44.0	166.0	100			PT125BR8/W502
	125	32		28.0	45.0	19.0	M8x1.25	44.0	166.0	100			PT125BR9/W502
	125	32		25.6	45.0	19.0	M8x1.25	44.0	166.0	100			PT125BR16/W502
 Dir. locking brake	125	32		22.0	45.0	19.0	M8x1.25	44.0	166.0	100			PT125DBR8/W502
	125	32		28.0	45.0	19.0	M8x1.25	44.0	166.0	100			PT125DBR9/W502
	125	32		25.6	45.0	19.0	M8x1.25	44.0	166.0	100			PT125DBR16/W502
Non-brake Free swivel	125	32		22.0	45.0	19.0	M8x1.25	44.0	166.0	100			PT125R8/W502
	125	32		28.0	45.0	19.0	M8x1.25	44.0	166.0	100			PT125R9/W502
	125	32		25.6	45.0	19.0	M8x1.25	44.0	166.0	100			PT125R16/W502



Nylon 6 with fiber-glass reinforced body, precision ball bearing swivel head, thermoplastic rubber wheel with ball bearings



TB/c Total locking brake
Total Lock system locks both swivel head and wheel simultaneously for a secure parking. Grey color Nylon brake pedal. Available for PolyTech series only.



DB/c Directional locking brake
Directional Lock permits free wheel rotation while swivel head remains locked, an easy way to keep equipment traveling straight. Green color Nylon brake pedal. Available for PolyTech series only.

T Threaded Stem Fitting

TPR Wheel Plastic hub, grey color thermoplastic rubber tire















Brake type	mm	mm		mm	mm	mm	mm	kg	Code
TB/c Total locking brake	100	25		1/2-13UNC	30.0	35.0	139.0	60	PT100BT2+/W402
	100	25		M10 P1.5	28.0	35.0	139.0	60	PT100BT3+/W402
	100	25		M12 P1.75	28.0	35.0	139.0	60	PT100BT4+/W402
	100	25		M16 P2.0	25.0	35.0	139.0	60	PT100BT5/W402
	100	25		1/2-20UNF	28.0	35.0	139.0	60	PT100BT10+/W402
	125	32		1/2-13UNC	30.0	44.0	166.0	100	PT125BT2+/W502
	125	32		M10 P1.5	28.0	44.0	166.0	100	PT125BT3+/W502
	125	32		M12 P1.75	28.0	44.0	166.0	100	PT125BT4+/W502
	125	32		M16 P2.0	25.0	44.0	166.0	100	PT125BT5/W502
	125	32		1/2-20UNF	28.0	44.0	166.0	100	PT125BT10+/W502
Non-brake Free swivel	100	25		1/2-13UNC	30.0	35.0	139.0	60	PT100T2+/W402
	100	25		M10 P1.5	28.0	35.0	139.0	60	PT100T3+/W402
	100	25		M12 P1.75	28.0	35.0	139.0	60	PT100T4+/W402
	100	25		M16 P2.0	25.0	35.0	139.0	60	PT100T5/W402
	100	25		1/2-20UNF	28.0	35.0	139.0	60	PT100T10+/W402
	125	32		1/2-13UNC	30.0	44.0	166.0	100	PT125T2+/W502
	125	32		M10 P1.5	28.0	44.0	166.0	100	PT125T3+/W502
	125	32		M12 P1.75	28.0	44.0	166.0	100	PT125T4+/W502
	125	32		M16 P2.0	25.0	44.0	166.0	100	PT125T5/W502
	125	32		1/2-20UNF	28.0	44.0	166.0	100	PT125T10+/W502



Code	W
T2+	19
T3+	17
T4+	19
T5	24
T10+	19

F Friction Ring Stem

TPR Wheel Plastic hub, grey color thermoplastic rubber tire

Brake type	 mm	 mm		 mm	 mm	 mm	 mm	 mm	 mm	 mm	 kg	Code
 Total locking brake	125	32		21.5	23.0	55.0	45.2	2.4	44.0	166.0	100	PT125BF3/W502
Non-brake Free swivel	125	32		21.5	23.0	55.0	45.2	2.4	44.0	166.0	100	PT125F3/W502



Option: Stainless Steel PolyTech Castors

For total water-proofing and corrosion resistant, all metal parts in stainless steel material



TB/c Total locking brake
Total Lock system locks both swivel head and wheel simultaneously for a secure parking. Grey color Nylon brake pedal. Available for PolyTech series only.



DB/c Directional locking brake
Directional Lock permits free wheel rotation while swivel head remains locked, an easy way to keep equipment traveling straight. Green color Nylon brake pedal. Available for PolyTech series only.

P Top Plate Fitting



TPR-SS Wheel Plastic hub, grey color thermoplastic rubber tire



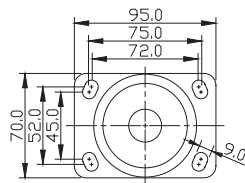













Brake type	mm	mm		mm	mm	mm	mm	mm	kg	Code
TB/c Total locking brake	100	25		95 x 70	75 x 52 / 72 x 45	9.0	35.0	142.0	60	PT100BP1SS/W402S
	125	32		95 x 70	75 x 52 / 72 x 45	9.0	44.0	166.0	100	PT125BP1SS/W502S
DB/c Dir. locking brake	125	32		95 x 70	75 x 52 / 72 x 45	9.0	44.0	166.0	100	PT125DBP1SS/W502S
	Non-brake Free swivel	100	25		95 x 70	75 x 52 / 72 x 45	9.0	35.0	142.0	60
	125	32		95 x 70	75 x 52 / 72 x 45	9.0	44.0	166.0	100	PT125P1SS/W502S



P1

T Threaded Stem Fitting

TPR-SS Wheel Plastic hub, grey color thermoplastic rubber tire

Brake type	mm	mm		mm	mm	mm	mm	kg	Code
TB/c Total locking brake	100	25		1/2-13UNC	30.0	35.0	139.0	60	PT100BT2+SS/W402S
	100	25		M10 P1.5	28.0	35.0	139.0	60	PT100BT3+SS/W402S
	100	25		M12 P1.75	28.0	35.0	139.0	60	PT100BT4+SS/W402S
	100	25		M16 P2.0	25.0	35.0	139.0	60	PT100BT5SS/W402S
	125	32		1/2-13UNC	30.0	44.0	166.0	100	PT125BT2+SS/W502S
	125	32		M10 P1.5	28.0	44.0	166.0	100	PT125BT3+SS/W502S
	125	32		M12 P1.75	28.0	44.0	166.0	100	PT125BT4+SS/W502S
	125	32		M16 P2.0	25.0	44.0	166.0	100	PT125BT5SS/W502S
Non-brake Free swivel	100	25		1/2-13UNC	30.0	35.0	139.0	60	PT100T2+SS/W402S
	100	25		M10 P1.5	28.0	35.0	139.0	60	PT100T3+SS/W402S
	100	25		M12 P1.75	28.0	35.0	139.0	60	PT100T4+SS/W402S
	100	25		M16 P2.0	25.0	35.0	139.0	60	PT100T5SS/W402S
	125	32		1/2-13UNC	30.0	44.0	166.0	100	PT125T2+SS/W502S
	125	32		M10 P1.5	28.0	44.0	166.0	100	PT125T3+SS/W502S
	125	32		M12 P1.75	28.0	44.0	166.0	100	PT125T4+SS/W502S
	125	32		M16 P2.0	25.0	44.0	166.0	100	PT125T5SS/W502S



 Stainless steel

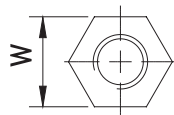

Code	W
T2+	19
T3+	17
T4+	19
T5	24
T10+	19



KAMARO

Retail Equipment Castors

An excellent partner for your mobile retail equipments.

A silent companion for your customers, giving them a smooth shopping trip and a peace of mind

Single disc travelator castor has provided shoppers decades of safety trip on and off the autowalks, and still, it is the most popular castor used throughout the retail outlets in the world.

Application:

Mobile retail equipments;
shopping trolleys;
airport baggage trolleys.

Size Available:



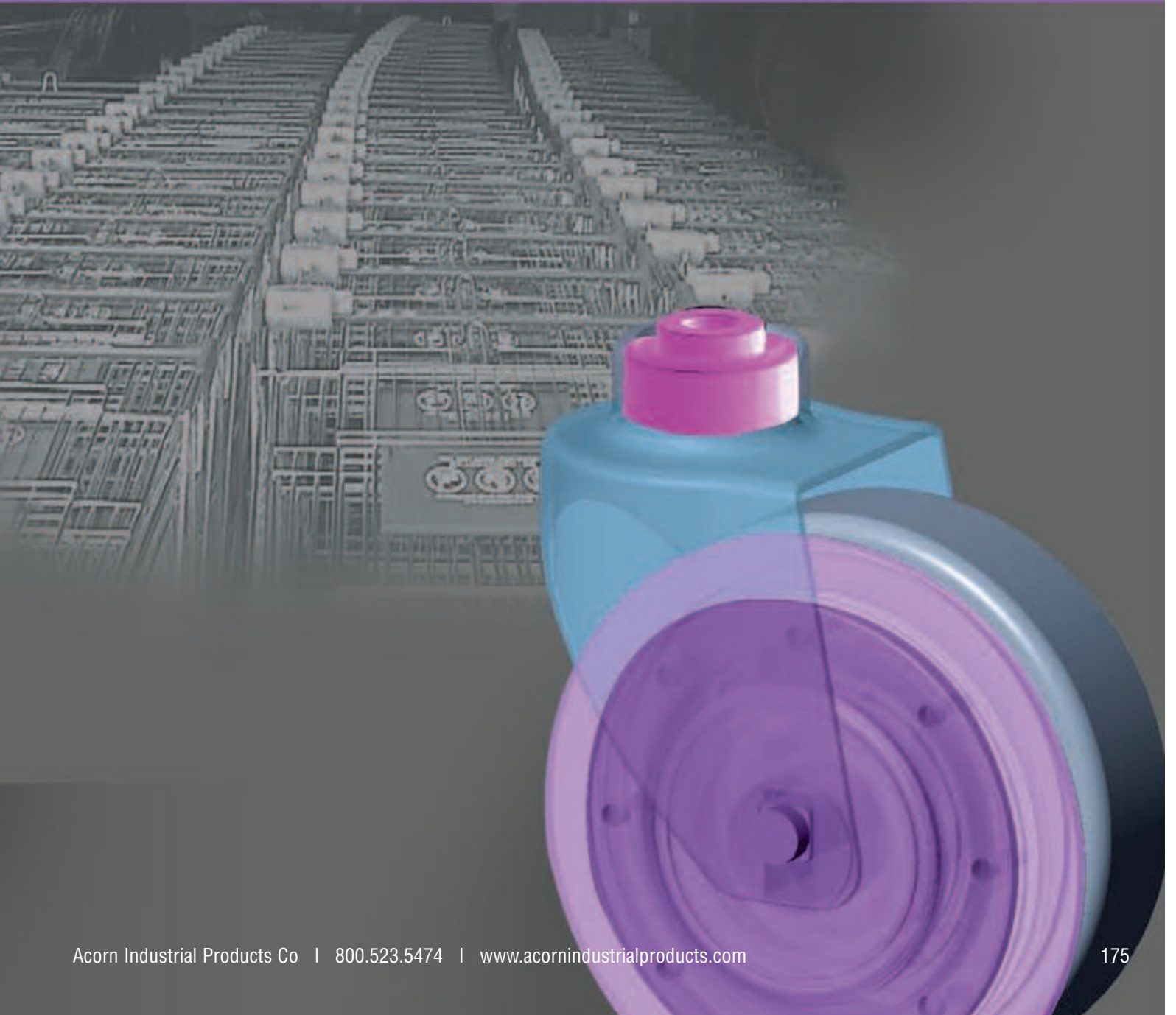









50x22, 60x25, 75x25, 100x32,
125x32mm



Pressed steel, zinc-chromatized double ballrace swivel yoke, designed mainly for shopping trolley and other mobile retail equipments; single disc walkway castor only available in 125mm size













H Bolt Hole Fitting

TPR Wheel Plastic hub, grey color thermoplastic rubber tire

Brake type	 mm	 mm		 mm	 mm	 mm	 kg	Code
Non-brake Free swivel	75	25		10.3	30.0	103.0	50	Y329H1/W303CX
	100	32		12.3	35.0	130.5	80	Y429H2/W403
	125	32		12.3	38.0	154.5	100	Y529H2/W503
	125	32		12.3	38.0	154.5	100	Y529H2/W503U
	125	32		12.3	41.5	158.5	100	Y533H2/W503



TPU Wheel Plastic hub, grey color polyurethane tire

Brake type	 mm	 mm		 mm	 mm	 mm	 kg	Code
Non-brake Free swivel	50	22		8.3	21.0	66.0	30	Y285H0/W285
	60	25		10.3	27.0	81.5	40	Y286H1/W286P
	75	25		12.3	30.0	103.0	50	Y329H2/W305CX
	100	32		12.3	35.0	130.5	80	Y429H2/W400
	125	32		12.3	38.0	154.5	100	Y529H2/W500



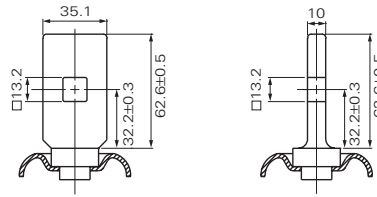

K1 Flange Fitting

H Bolt Hole Fitting

TPU Wheel Plastic hub, grey color polyurethane tire

Brake type	mm	mm		mm	mm	kg	Code	
Non-brake Free swivel	100	32		12.3	35.0	130.5	80	Y429H2/W427
	125	32		12.3	38.0	154.5	100	Y529H2/W527
	125	32		12.3	41.5	158.5	100	Y533H2/W527



K Flange Fitting

TPR Wheel Plastic hub, grey color thermoplastic rubber tire

Brake type	mm	mm		mm	mm	kg	Code
Non-brake Free swivel	125	32		38.0	157.5	100	Y529K1/W503
	125	32		38.0	157.5	100	Y529K1/W503U



TPU Wheel Plastic hub, grey color polyurethane tire

Brake type	mm	mm		mm	mm	kg	Code
Non-brake Free swivel	125	32		38.0	157.5	100	Y529K1/W527
	125	32		38.0	157.5	100	Y529K1/W500



Castor designed for mobile equipment used on travelator system

Pressed steel double ballrace swivel yoke, zinc-chromatized, pressed steel hub and threadguard, flanged polyurethane side disc, grey color non-marking rubber tire (80+/-5 Shore A)

Designed for the following palletsize:

Track width: approx. 2.75 mm
Groove width: approx. 5.7 mm
Groove depth: >10.0 mm

Wheel:

Disc wheel: Ø 130 mm
Disc width: 4.5 mm
Engagement travel: 8 mm

R Round Stem

SRB Wheel Pressed steel hub, grey color elastic tire

Free swivel	mm	mm		mm	mm	mm	mm	mm	mm	kg	Code
Left-hand	125	32		22.0	45.0	19.0	M8x1.25	42.5	166.3	100	Y525R8/W525L
Right-hand	125	32		22.0	45.0	19.0	M8x1.25	42.5	166.3	100	Y525R8/W525R
Fixed											
Left-hand	125	32		22.0	45.0	19.0	M8x1.25	42.5	166.3	100	Y525R8F/W525L
Right-hand	125	32		22.0	45.0	19.0	M8x1.25	42.5	166.3	100	Y525R8F/W525R



H Bolt Hole Fitting

SRB Wheel Pressed steel hub, grey color elastic tire

Free swivel	mm	mm		mm	mm	mm	kg	Code
Left-hand	125	32		10.3	42.5	163.8	100	Y525H1/W525L
	125	32		12.3	42.5	163.8	100	Y525H2/W525L
	125	32		12.8	42.5	163.8	100	Y525H3/W525L
Right-hand	125	32		10.3	42.5	163.8	100	Y525H1/W525R
	125	32		12.3	42.5	163.8	100	Y525H2/W525R
	125	32		12.8	42.5	163.8	100	Y525H3/W525R



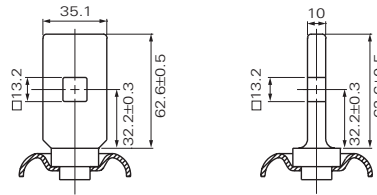











K1 Flange Fitting

K Flange Fitting

SRB Wheel Pressed steel hub, grey color elastic tire

Free swivel	 mm	 mm		 mm	 mm	 kg	Code
Left-hand	125	32		42.5	166.8	100	Y525K1/W/525L
Right-hand	125	32		42.5	166.8	100	Y525K1/W/525R
Fixed							
Left-hand	125	32		42.5	166.8	100	Y525K1F/W/525L
Right-hand	125	32		42.5	166.8	100	Y525K1F/W/525R



On regular flat floor

 = 100kgs per castor
kg on level floor



On moving travelator

 = 33kgs per castor
kg on travelator

Once trolley landed on the travelator, PU side disc will drop into the pit of the belt, simultaneously locks up the wheel and prevent any movement forward or backward, allowing the user and trolley a safe ride on the travelator. Safety standard requires maximum slope of travelator does not exceed 12°.

Custom Made

Our commitment to service is a serious undertaking. To provide better solutions to our customers, we proceed beyond castors made to order.

Within the last two years, we have successfully developed castor linkage system for medical diagnostic machines, cold storage support and parts used for hospital bed system.

Call us to find out +886-2-88095011 or contact us at service@catis.com.tw

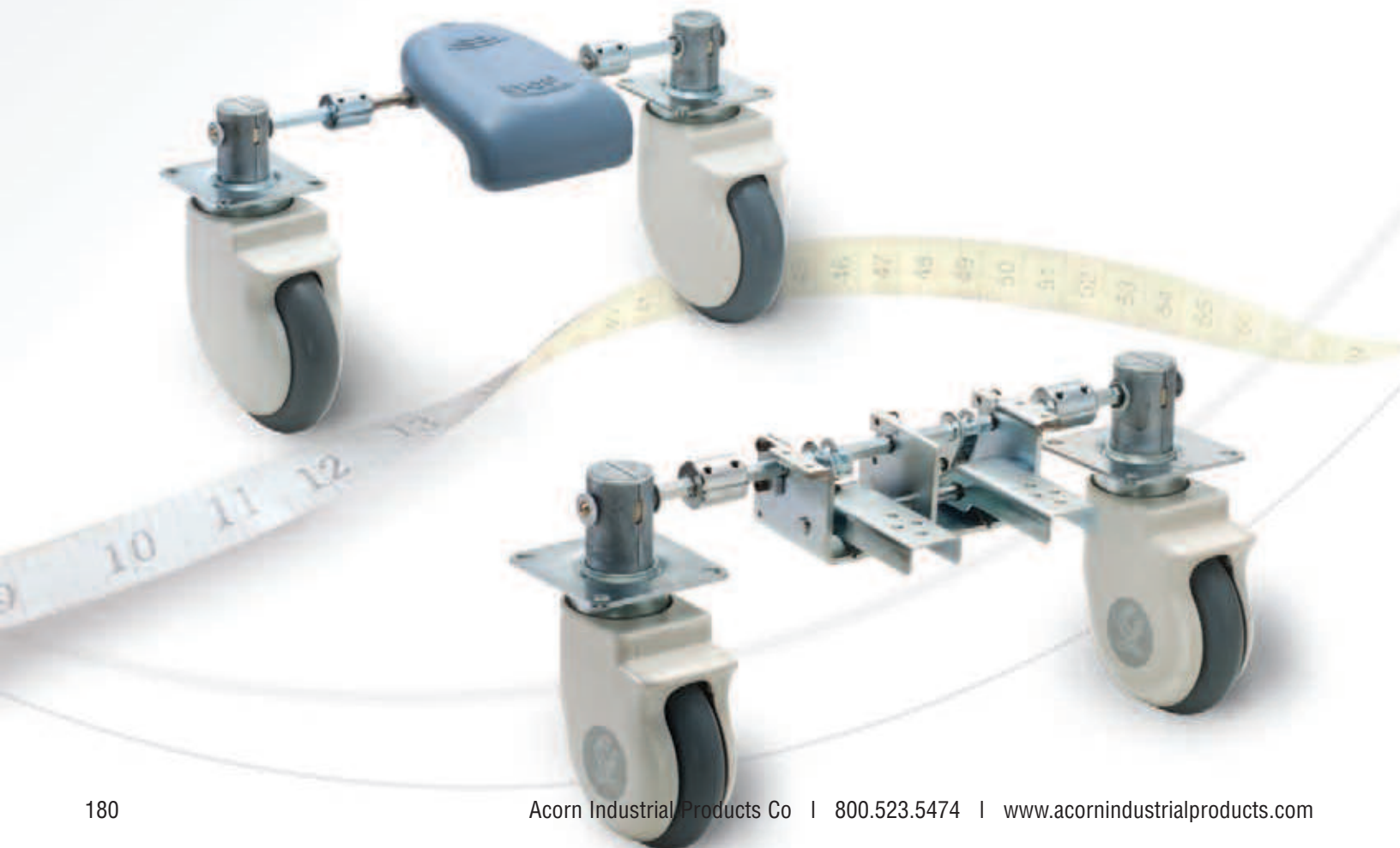



Precision ball bearing

Single row radial ball bearing with extremely low resistance even under heavy load, super smooth and quiet during running. For castors intended for higher value-added products, there is no other substitute.

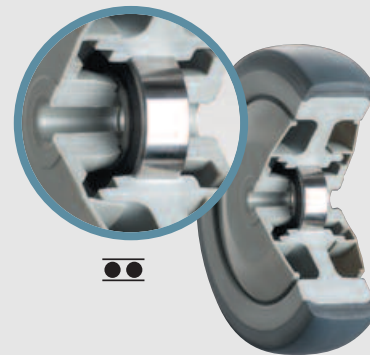

Ball bearing

New generation of ball bearing with low rolling resistance and reduced noise level. High grade tool steel ballrace designed for lasting performance and maximum reliability. Option for stainless steel is available.

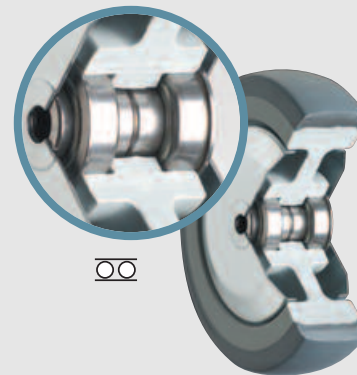

Delrin plain bearing

This is made of extremely durable engineering plastic. It is corrosion resistant, suitable for a wide range of temperature and humidity environments. This bearing should be used for applications where brine, excessive moisture or liquid are present.

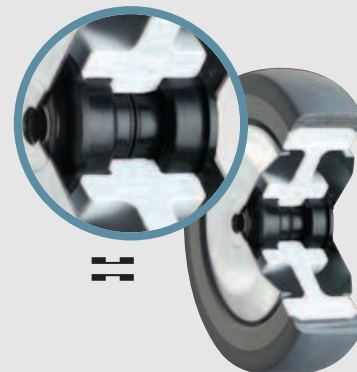

Roller bearing

Roller bearing is very sturdy, and its low rolling resistance makes it suitable to carry a greater load.

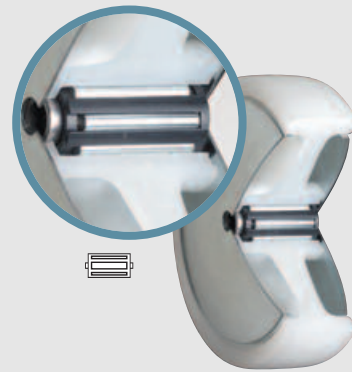

Plain bore bearing

Tough nylon bearing built in with the wheel center forming a castor suitable for wide range of environmental conditions and requiring minimal maintenance.

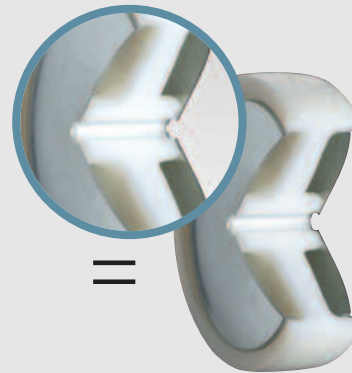

Option: Stainless steel bearing is also available



stainless steel



Delrin plain bearing with stainless steel bushing



stainless steel plain bore bearing



stainless steel roller bearing



stainless steel precision ball bearing



stainless steel ball bearing

APPENDIX Mounting Fitting

Unless specified, castor with directional locking mechanism, top plate installed with longer length parallel to direction of travel

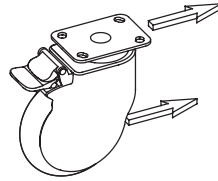

P Top Plate Fitting

Swivel

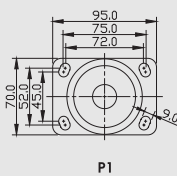

P1

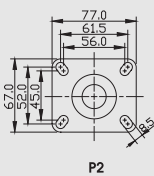

P2

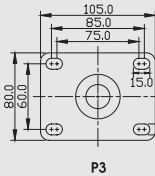

P3

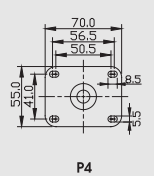

P4

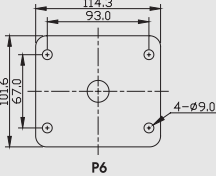

P6

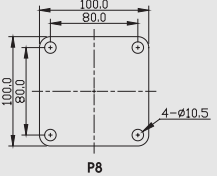

P8

Fixed

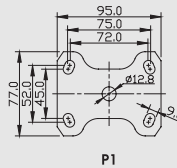

P1

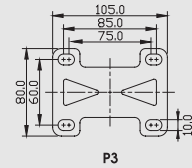

P3

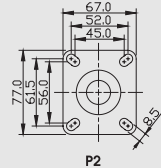

P2

Direction of travel →

H Bolt Hole Fitting

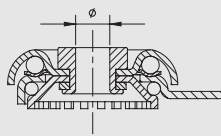

Code	Ø	Mating Bolt Size
H1	10.3	M10
H2	12.3	M12
H3	12.8	1/2"

F Friction Ring Stem

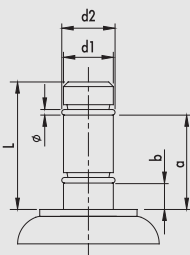

Code	d1	d2	L	a	b	Ø Friction Ring
F3	21.5	23.0	55.0	45.2	-	2.4 (single ring)
F31	21.5	23.4	55.0	45.2	10.0	2.6 (double ring)
F32	21.5	23.0	55.0	45.2	10.0	2.4 (double ring)
F5	11.1	12.0	35.2	25.4	-	1.6 (single ring)

Unless specified, castor with directional locking mechanism, top plate installed with longer length parallel to direction of travel

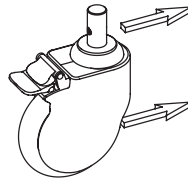

R Round Stem

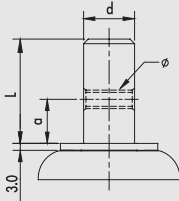

Code	d	L	a	Ø
R6	18.0	45.0	19.0	M8 x 1.25
R7	20.0	45.0	19.0	M8 x 1.25
R8	22.0	45.0	19.0	M8 x 1.25
R9	28.0	45.0	19.0	M8 x 1.25

Code	d	L	a	Ø
R14	22.5	45.0	18.5	M8 x 1.25
R15	19.0	45.0	18.5	M8 x 1.25
R16	25.6	45.0	19.0	M8 x 1.25
R131	19.4	40.0	19.0	6.3

JT Threaded Stem Fitting

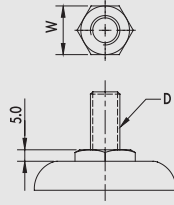

Code	D	W
JT1	3/8-16UNC x 1"	21
JT2	1/2-13UNC x 1"	21
JT3	M10 x 25mm P=1.5	21
JT4	M12 x 25mm P=1.75	21

Code	D	W
JT5	M16 x 25mm P=2.0	23
JT6	5/8-11UNC x 1-1/4"	26
JT7	1/2-12UNC x 1"	21
JT10	1/2-20UNF x 25mm	21

T Threaded Stem Fitting with Hex Base Washer

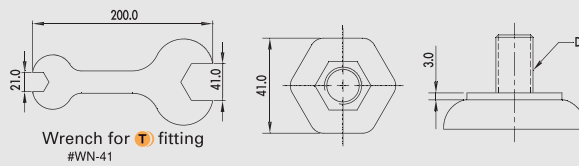

Code	D
T1	3/8-16UNC x 1"
T2	1/2-13UNC x 1"
T3	M10 x 25mm P=1.5
T4	M12 x 25mm P=1.75
T5	M16 x 25mm P=2.0
T6	5/8-11UNC x 1-1/4"
T7	1/2-12UNC x 1"
T10	1/2-20UNF x 25mm

Note | Changes to listed specifications can be arranged to suit special requirements. such modifications largely depend on the size of orders.

The following are standard expanding fitting to go with bolt hole type castors

Round fitting

Ø (mm)	Expanding Range (d)	Mating Bolt hole Fitting (mm)	Code
M10 x P1.50	19.0~21.5	H1 (10.3)	EF19R-M10
M10 x P1.50	21.5~24.0	H1 (10.3)	EF22R-M10
M10 x P1.50	27.0~30.0	H1 (10.3)	EF27R-M10
M12 x P1.75	19.0~21.5	H2 (12.3)	EF19R-M12
M12 x P1.75	21.5~24.0	H2 (12.3)	EF22R-M12
M12 x P1.75	27.0~30.0	H2 (12.3)	EF27R-M12

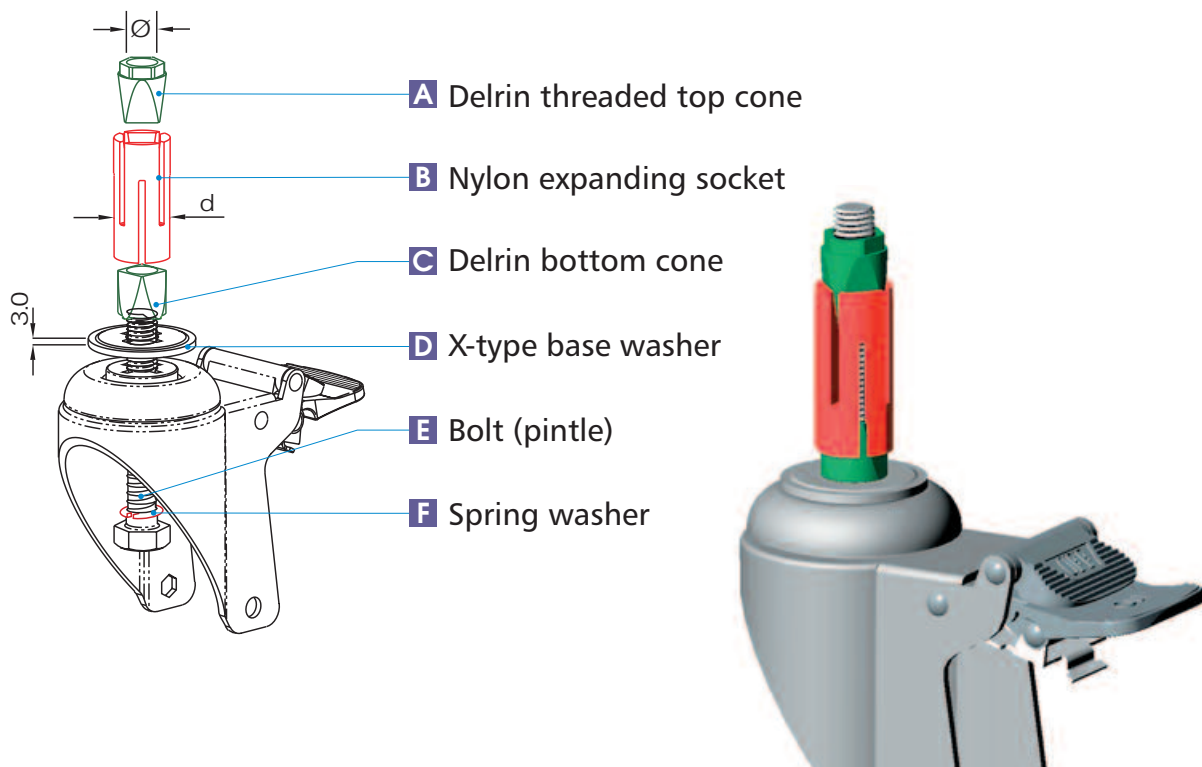

- When fitting castors with expanding fitting, make sure that fitting is fully inserted into the tube, hand tight it to slug fit with the tube, then torque the bolt (pintle) as recommended.
- Before pushing the fitting into the tube, remove any burrs at the tube opening.
- Periodically inspect and tighten up the bolt to assure firm fitting.

Square fitting

Ø (mm)	Expanding Range (d)	Mating Bolt hole Fitting (mm)	Code
M10 x P1.50	19.0~21.5	H1 (10.3)	EF19S-M10
M10 x P1.50	21.5~24.0	H1 (10.3)	EF22S-M10
M10 x P1.50	27.0~30.0	H1 (10.3)	EF27S-M10
M12 x P1.75	19.0~21.5	H2 (12.3)	EF19S-M12
M12 x P1.75	21.5~24.0	H2 (12.3)	EF22S-M12
M12 x P1.75	27.0~30.0	H2 (12.3)	EF27S-M12

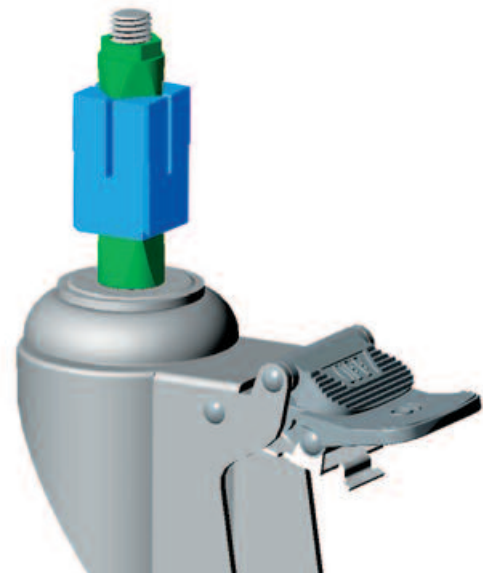
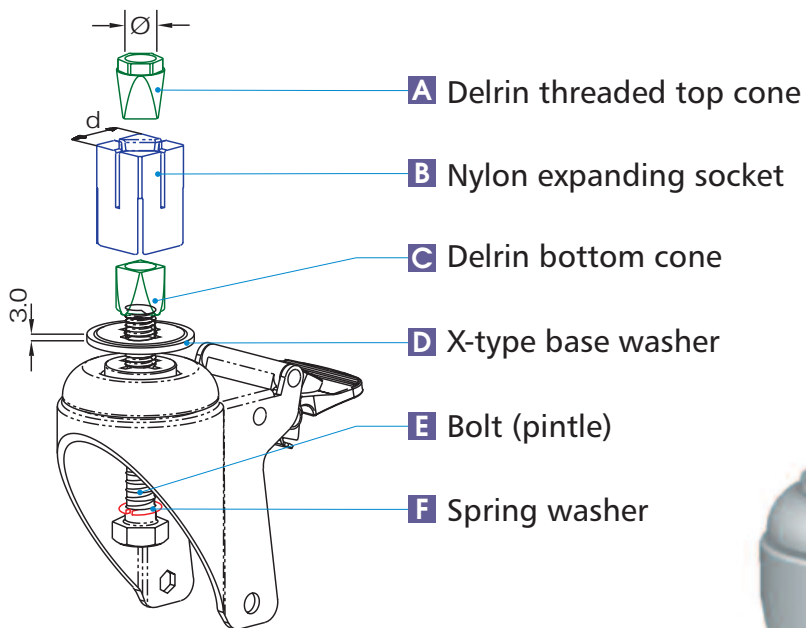

- Minimum tube thickness 1.4mm, under which tube tends to split when high torque applied.
- Torque recommended: Round Fittings 100 ~110 in-lbs; Square Fittings 80 ~ 100 in-lbs.
- Bolt (pintle) length should be 90mm or above.
- When ordering, please specify tube inner and outer diameter.

Wheel



wheel dia.



tread width



overall tread width



bearing type



hub length



hub material



tread material



axle hole dia.



threadguards

Castor



plate size



hole spacing of plate



hole dia. of plate



offset



overall height



plate size



hole spacing of plate



hole dia. of plate



overall height



round stem dia.



round stem length



location of drilling hole



drilling hole dia.



threaded stem spec.



threaded stem length

Castor



bolt hole dia.



offset



overall height



swivel radius



friction ring stem dia.



friction ring size



friction ring stem length



friction ring location



friction ring wire dia.

Bearing



Delrin plain bearing with metal bushing



plain bore bearing



roller bearing



precision ball bearing



ball bearing



stainless steel



Delrin plain bearing with stainless steel bushing



stainless steel plain bore bearing



stainless steel roller bearing



stainless steel precision ball bearing



stainless steel ball bearing

Others



Durometer of wheel tread



load capacity (kgs)

Load Capacity as determined per EN 12526 to EN12533,
Load Capacity / Per Castor (kgs)